

## **D12.2 Pre-requisites and design criteria for new MAR systems in compliance with EU WFD and GWD (including pre-treatment)**



The research leading to these results has received funding from the European Community's Seventh Framework Programme under Grant Agreement No.308339 (Project DEMEAU).

**Title:** Pre-requisites and design criteria for new MAR systems in compliance with EU WFD and GWD (including pre-treatment)

**Summary:** This project report summarizes work conducted in work package 12 of the DEMEAU project. Along with Deliverable 12.1 it covers all tasks from work package 12 as formulated in the Description of Work (DoW). This report contains information about (pre-) feasibility studies, design recommendations and pre-treatment options for different types of MAR.

The wide range of hydrogeological features encountered in reality makes a site-by-site approach indispensable. As part of this effort the hydrogeological pre-requisites for surface spreading and deep well injection techniques are described in detail. In chapter 2, ten essential hydrogeological parameters are defined by objective criterias. The following chapter outlines and describes how to obtain these essential hydrogeological parameters. This feasibility assessment starts with the screening of the potential site based on a structured procedure. Site investigations start with relatively cheap but numerous field and laboratory testing and continue to more cost-demanding but less numerous tests. With this procedure it is possible to carry out technical site feasibility in a cost- and time efficient way.

The fourth chapter investigates the International Hydrogeological Map of Europe (IHME 1500) as a planning basis for pre-feasibility of new MAR sites. It was found that the IHME 1500 is useful for a pre-assessment, but detailed regional and local scale maps (and investigations) are additionally necessary to effectively assess hydrogeological features.

The final chapter deals with pre-treatment options for MAR. Pre-treatment is necessary to remove critical contaminants from the source water to i) enhance system performance and removal efficiencies, ii) ensure the long-term functioning of the system, iii) meet regulatory demands and iv) ensure beneficial uses of the aquifer beyond the attenuation zone. Available pre-treatment methods in relation to source water type and intended end-use are described. Based on chemical concentrations in source water and intended end-use the most appropriate pre-treatment method can be assessed from a table.

Altogether this report thus provides guidance in designing new MAR systems based on a sound hydrogeological site characterisation and pre-feasibility assessment based on available information and parameters obtained from structured investigations.

**Grant agreement no:** 308339 (Project DEMEAU)

**Work Package:** WP12

<b>Deliverable number:</b>	D 12.2
<b>Partner responsible:</b>	KWR, KWB, HYDOR, FHNW
<b>Deliverable author(s) (alphabetical order):</b>	Angelika Huber (HYDOR), Beatriz de la Loma Gonzalez (KWR), Christoph Sprenger (KWB), Julia Plattner (FHNW), Linda Stamm (FHNW), Ragini Hüscher (FHNW), Stephan Hannappel (HYDOR)
<b>Quality assurance (alphabetical order):</b>	Christoph Sprenger (KWB), Ester Vilanova (Amphos 21)
<b>Planned delivery date:</b>	M36
<b>Actual delivery date:</b>	M36
<b>Dissemination level:</b>	PU

© 2014 DEMEAU

The European Commission is funding the Demonstration project 'Demonstration of promising technologies to address emerging pollutants in water and waste water' (DEMEAU, project number 308330) within the context of the Seventh Framework Programme 'Environment'. All rights reserved. No part of this book may be reproduced, stored in a database or retrieval system, or published, in any form or in any way, electronically, mechanically, by print, photograph, microfilm or any other means without prior written permission from the publisher.

## Table of contents

LIST OF FIGURES .....	6
LIST OF TABLES.....	8
1 INTRODUCTION.....	9
2 HYDROGEOLOGICAL PRE-REQUISITES FOR SURFACE SPREADING AND DEEP WELL INJECTION TECHNIQUES .....	10
2.1 Introduction .....	10
2.2 Aquifer confinement .....	13
2.3 Aquifer permeability .....	13
2.4 Aquifer thickness.....	13
2.5 Depth-to-water and effective porosity.....	14
2.6 Aquifer pore type and consolidation .....	14
2.7 Uniformities of hydraulic properties .....	14
2.8 Aquifer salinity .....	14
2.9 Regional hydraulic gradient.....	15
2.10 Topographic slope.....	15
References .....	16
3 IDENTIFYING AND CHARACTERIZING OPTIMUM CONDITIONS FOR MAR PROJECTS.....	17
3.1 Introduction .....	17
3.2 Identifying and characterization optimum conditions for surface spreading recharge projects .....	17
3.2.1 Phase I: Near-surface zone characterization (0-3 m below surface).....	18
3.2.2 Phase II: Subsurface characterisation .....	23
3.2.3 Data integration and design aspects.....	26
3.3 Identifying and characterization optimum conditions for well injection projects.....	34
3.3.1 Characterization of optimum conditions for a well injection MAR system.....	35
3.3.2 Solutions to obstacles to the implementation of well injection MAR systems: Dutch Examples .....	39
3.3.3 Obstacles to the maintenance of well injection MAR systems .....	44
References .....	51
4 MAPPING CRITERIA FOR MAR PRE-FEASIBILITY: APPLICATION OF THE INTERNATIONAL HYDROGEOLOGICAL MAP OF EUROPE (IHME 1500).....	55
4.1 Introduction .....	55
4.2 Methods and materials.....	55
4.3 Results.....	56
4.4 Conclusions .....	62
References .....	63
5 PRE-TREATMENT OPTIONS DURING MAR.....	64
5.1 Introduction .....	64
5.2 Brief description of main treatment steps .....	67
5.2.1 Preliminary treatment.....	68

5.2.2	Primary treatment.....	68
5.2.3	Secondary treatment .....	68
5.2.4	Tertiary treatment.....	69
5.2.5	Advanced treatment .....	69
5.3	<i>Source water types and main water quality concerns for MAR.....</i>	<i>69</i>
5.3.1	Surface water .....	71
5.3.2	Storm water .....	74
5.4	<i>Treated waste water.....</i>	<i>75</i>
5.5	<i>Pre-treatment methods during MAR in relation to source water and end-use .....</i>	<i>77</i>
5.5.1	MAR sites producing water mainly for environmental benefits .....	80
5.5.2	MAR sites producing water mainly for agricultural purposes.....	83
5.5.3	MAR sites producing drinking water .....	84
5.6	<i>Summary of pre-treatment methods at selected European MAR sites.....</i>	<i>88</i>
5.7	<i>Conclusions .....</i>	<i>88</i>
	<i>References .....</i>	<i>91</i>

## List of Figures

Figure 3-1: Pyramid approach in characterizing optimum conditions for surface spreading projects. ....	18
Figure 3-2: Cross-sectional view of geometry and parameter explanations for single-ring infiltrometer based on Bouwer (2002).....	21
Figure 3-3: Crossection from a Dutch ASTR pilot, located in Eastern Nederlands (St. Jansklooster) showing the redox zonation after 2 years of continued injection: O2=oxic, O2*=penoxic, NO3=suboxic, SO4=anoxic, n=ative deep anoxic groundwater. (Numbers within soil column indicate median grain size -1 =100, 9 = 900 $\mu\text{m}$ -; numbers next to well screens and resistivity sensors indicate travel time [d]). Modified from (Stuyfzand, 2011).....	38
Figure 3-4: Schematic redox zonation of an ASR system in an originally deep anoxic aquifer. i = oxic infiltration water; A = (sub)oxic infiltrate; B = anoxic infiltrate in Buffer zone; B* = anoxic infiltrate from buffer zone but strongly depleted in Fe <sup>2+</sup> , Mn <sup>2+</sup> , NH <sub>4</sub> <sup>+</sup> and PO <sub>4</sub> <sup>3-</sup> by sorption to newly formed ferrihydrite; M = mixture of B and N; N = deep anoxic native groundwater. After (Stuyfzand, 2011).....	39
Figure 3-5: Phases of an ASR in coastal areas: injection, storage and recovery. The graph shows the lateral flow and buoyancy effects during recovery.....	40
Figure 3-6: Setup of an ASR field trial in Nootdorp, in the South of The Hague, with chloride concentrations in the target aquifer around 1000 mg/L. MW = monitoring well, CTD = electric conductivity, temperature, and pressure datalogger, R.S.F. = rapid sand filtration, S.S.F. = slow sand filtration. Taken from Zuurbier et al. (2014b). ....	41
Figure 3-7: Schematic cross-section of a freshmaker set-up.....	42
Figure 3-8: Cross section of the Freshmaker pilot set-up at Ovezande, in the South Western Delta of the Netherlands. The fresh water had a thickness of 9 meters with a 6m mixing zone and an underlying aquifer with a salinity of around 16800 mg Cl/l. MW = monitoring well, HDDW = horizontal directional drilled well. Taken from (Zuurbier et al., 2014a).....	43
Figure 3-9: Schematic cross-section of a fresh water lens on top of a brackish aquifer* and different types of groundwater abstraction, from left to right: fresh well salinizing by upconing, the fresh-keeper without reverse osmosis (RO), the freshkeeper with RO, and brackish water with RO (BWRO). *The chloride stratification of the aquifer is indicated on the left of the cross-section and the chlorinity of the RO-concentrate is approximately 6,000 mg/l when the quantity of permeate equals the quantity of concentrate. Taken from (Stuyfzand and Raat, 2010).....	44
Figure 3-10: Location of observation points in an infiltration well and different types of clogging deduced from the measured water levels. Figure after Loma (2013).....	45
Figure 4-1: Spatial distribution of all 278 (active and inactive) MAR sites from the European MAR catalogue (modified from Hannappel et al. 2014) and “aquifer types” from the IHME1500 (BGR & UNESCO (eds.), 2014).....	57
Figure 4-2: Distribution of MAR sites within the attribute class “Aquifer Type” of the IHME 1500. ....	58
Figure 4-3: Distribution of MAR sites in different Aquifer Types of the IHME 1500 in selected countries.....	59
Figure 4-4: Comparison of hydraulic conductivity data from the MAR catalogue (Hannappel et al. 2014) with the attribute “aquifer type” from the IHME 1500 (BGR & UNESCO (eds.), 2014).....	59
Figure 4-5: Distribution of MAR sites within the attribute class “lithological levels” of the IHME 1500. ....	60
Figure 4-6: Distribution of MAR sites within the lithological levels of the IHME 1500 in selected countries.....	61

Figure 4-7: Comparison of aquifer type data from the MAR catalogue with lithological information from the IHME 1500. ....	61
Figure 5-1: Main components of MAR system with pre- and post-treatment options. ....	65
Figure 5-2: Typical water sources, capture and pre-treatment methods for MAR (Dillon et al., 2009a). MF: Microfiltration, GAC: Granular Activated Carbon, DAFF: Dissolved Air Flotation and Filtration, RO: Reverse Osmosis. ....	66
Figure 5-3: Waste water treatment system prior to injection into the aquifer of Baix Llobregat WWTP and WRP (Ortuño et al., 2012) .....	82
Figure 5-4: Process scheme of pre-treatment at Torreele plant (van Houtte and Verbauwhe, 2008) ....	87
Figure 5-5: Typical pre-treatment methods in relation to the water end-use and the source water based on case studies from European MAR sites (Belgium, Germany, Italy, Netherlands, Spain and Switzerland) .....	88

## List of Tables

Table 2-1:	Hydrogeological pre-requisites for surface spreading and well injection methods (modified and extended after Dillon and Jimenez (2008)).....	10
Table 3-1:	Overview of equations for $K_{sat}$ calculation (modified from Vienken and Dietrich (2011)).....	19
Table 3-2:	Measure of scale and typical scale ranges for hydrogeological tests (modified after Schulze-Makuch et al. (1999)). .....	27
Table 3-3:	Magnitude of total porosity ( $n_{tot}$ ), effective porosity ( $n_e$ ), hydraulic conductivity (K) and suction head ( $h_{we}$ )of various unconsolidated aquifer materials (after Hölting and Coldewey (2009) and Bouwer (2002))......	28
Table 3-4:	Dynamic viscosity of water as a function of temperature.....	33
Table 3-5:	Filter layer thickness and grain size distribution according to DIN EN 12904.....	34
Table 3-6:	Overview of the preferred rehabilitation methods in The Netherlands (after Bonte (2009)) ...	46
Table 3-7:	Comparison between the three deep infiltration systems .....	47
Table 5-1:	Overview of pre-treatment steps for MAR systems.....	67
Table 5-2:	Main water quality concerns by water source .....	70
Table 5-3:	Pre-treatments for MAR using reclaimed water and storm water and relative effectiveness of each treatment for removal of TSS and liable organics (Dillon et al., 2008) ...	70
Table 5-4	Analytical results of a three-year monitoring program of the major river systems, streams tributaries and ditches in Northern Greece (Simeonov et al., 2003; Council Directive 98/83/EC).....	72
Table 5-5:	Water pollutants by industrial sector (Hanchang, n.d.) .....	73
Table 5-6:	Matrix for selection of appropriate pre-treatment options for ARR and SAT (Sharma et al., 2015a; NRMCC, EPHC, & NHMRC, 2009).....	77
Table 5-7:	Overview of pre-treatment methods used for MAR types producing water for multi purposes without managed abstraction scheme .....	82
Table 5-8:	Overview of pre-treatment methods used for MAR types producing water for (restricted) agricultural purposes.....	83
Table 5-9	Overview of pre-treatment methods used for MAR types producing drinking water.....	87



## 1 Introduction

This project report summarizes work conducted in work package 12 of DEMEAU. Along with the Deliverable 12.1 it covers the tasks from work package 12 as formulated in the Description of Work (DoW). The content of the different sections is interrelated, but each section is organized as an independent part. Each section can be found as a stand-alone report in the DEMEAU tool box (<http://demeau-fp7.eu/toolbox/>) for download. The sections in this report cover the following topics:

- Hydrogeological pre-requisites for surface spreading techniques and deep well injection are described in detail (section 2)
- Procedures for field site investigation methods for surface spreading and deep well injection techniques (section 3)
- Application of the International Hydrogeological Map of Europe (IHME 1500) for mapping MAR features (section 4)
- Pre-treatment options for MAR systems (section 5)

## 2 Hydrogeological pre-requisites for surface spreading and deep well injection techniques

Beatriz de la Loma González<sup>1</sup>, Christoph Sprenger<sup>2</sup>

1 - KWR Watercycle Research Institute, Groningehaven 7, 3430 BB Nieuwegein, The Netherlands

2 - Kompetenzzentrum Wasser Berlin, Cicerostr.24, 10709 Berlin, Germany

Quality assurance: Ester Vilanova (Amphos 21)

### 2.1 Introduction

Detailed knowledge of hydrogeological features is necessary for adequately selecting a site for man-made aquifer recharge. Hydrogeological pre-requisites for surface spreading and well injection methods are shown in Table 2-1. This table is based on the previous work from Dillon and Jimenez (2008) and supplemented with objective criteria for the listed features and extended by additional features. Dillon and Jimenez (2008) state that not all hydrogeological situations can be covered (e.g. semi-confined conditions) and the wide range of hydrogeological features encountered in reality makes a site-by-site approach indispensable. Anyhow, Table 2-1 may serve as an entry level assessment and along with site specific investigation it is one way to gain a sound hydrogeological understanding of the site.

Table 2-1: Hydrogeological pre-requisites for surface spreading and well injection methods (modified and extended after Dillon and Jimenez (2008)).

Parameter	Criteria	Suitability assessment
Aquifer confinement	Confined	<p>Well injection only</p> <p>Protection by impermeable layer from surface contamination</p> <p>Storage capacity depends on aquifer transmissivity and water quality (this affects the buffer zone that must be left to separate the injected water from the groundwater) (Pyne 2005)</p>
	Unconfined	<p>Surface spreading viable</p> <p>No protective cover from surface contamination</p> <p>Storage capacity depends on depth-to-water table and effective porosity</p>

Parameter	Criteria	Suitability assessment
Target aquifer permeability, $k_f$ (m/s)	$< 10^{-6}$	Very low, limited suitability
	$10^{-6} - 10^{-5}$	Low, limited suitable
	$10^{-5} - 10^{-4}$	Medium, suitable
	$10^{-4} - 10^{-3}$	High, suitable
	$>10^{-3}$	Very high, suitable
Saturated thickness in target aquifer (m)	$<10$	Thin, high potential recovery rate
	10-50	Medium, medium potential recovery rates
	$>50$	Thick, low potential recovery rate
Depth-to-water or thickness of unsaturated zone (m)	$<10$	Limited potential storage potential
	10-30	Good potential storage potential
	$>30$	High potential storage potential, groundwater mounding can be neglected
Aquifer pore type and consolidation	Porous	Most suitable
	Porous/ Fractured	suitable (limited)
	Fractured	suitable (limited), in consolidated aquifers simpler well completion and easier to prevent well clogging
	Fractured/Karstified	suitable (limited)
	Karstified	suitable (limited)
Uniformity of hydraulic properties	Homogenous (e.g. variance of $K \leq 0.5 \log_{10}$ )	Minimal mixing and higher recovery rates for well injection if native groundwater is brackish

Parameter	Criteria	Suitability assessment
	Heterogeneous (e.g. variance of $K \geq 0.5 \log_{10}$ )	Lower recovery rates for well injection if native groundwater is brackish In karstic and fractured aquifers limited ability to store recharged water
Redox state of native groundwater	Aerobic	Higher inactivation rates for pathogens and some endocrine disruptors (EDCs) Higher removal for some pharmaceutical active compounds (PhACs)
	Sub-oxic	Higher removal for some pharmaceutical active compounds (PhACs)
Salinity of native groundwater	Fresh (TDS <1000 mg/l)	Fresh aquifers are suitable for aquifer recharge.
	Brackish/saline (TDS >1000 mg/l)	Mixing with native saline groundwater must be minimized (e.g. injection of buffer volume) Saline groundwater causes buoyancy effects (density driven drift in lateral direction)
Hydraulic gradient	Gentle (<0.1%)	Small lateral (and vertical) hydraulic gradients promote conservation of the injected water in the recharge zone
	Moderate to steep (> 0.1 %)	Lateral flow can cause the injected fresh water to move outside of the recharge zone
Topographic slope (not relevant for injection methods)	Gentle (< 5%)	Surface spreading suitable
	Moderate to steep (> 5%)	Surface spreading not suitable

## 2.2 Aquifer confinement

Generally, aquifers can be divided in i) unconfined (also called phreatic or water table aquifers), where water can infiltrate from ground surface and percolate to the water table below which all pore spaces are entirely filled with water and ii) confined, where the top of aquifer is covered by relatively impermeable layers and infiltration from ground surface does not reach the water table. This makes clear that confined aquifers are not suitable for surface spreading methods since the confining, low-permeability layers may cause perched groundwater or water logging.

Aquifers confined both above and below by competent confining layers prevent a) mixing of the injected water with water up-coning during recovery or b) vertical migration during storage periods.

## 2.3 Aquifer permeability

Without a suitable aquifer there is no opportunity for recharge and storage. The aquifer permeability is a compromise between good hydraulic performance, such as high infiltration rates and high storage capacity associated to high permeabilities and good purification capacity associated to fine grains and organic carbon in sediments. For most MAR techniques an aquifer permeability higher than 5 m/day and 100 m/day is recommended, but also MAR sites with marginally lower or higher permeabilities may perform well.

## 2.4 Aquifer thickness

Aquifer thickness is per definition the saturated thickness. Generally, thin aquifers hold higher potential recovery rates than thicker aquifers.

In well injection systems thicker aquifers allow for faster storage of big volumes of water. However the transmissivity of an aquifer (thickness times permeability) should be limited since a high value could mean easier migration of the injected bubble. It can also result in higher maintenance costs due to higher sensitivity for mechanical clogging.

Despite the disadvantages in storage volume, thinner aquifers are favorable in some cases. When the groundwater quality is significantly different than the injected water, a thinner aquifer will result in a transition zone between the two types of water further away from the recovery well. Thinner aquifers are also less susceptible to lateral drift, because the injected bubble is wider and therefore less likely to move out of the capture zone. Thinner aquifers are also less vulnerable to buoyancy effects, which is beneficial when dealing with saline aquifers. Buoyancy effects may cause salinization at the bottom of the ASR well during recovery, making a part of the freshwater irrecoverable. Thinner aquifers prevent this since the fresh-salt water interface is further from the ASR well.

## 2.5 Depth-to-water and effective porosity

The depth-to-water can be defined as the vertical distance between the elevation of the land surface and the elevation of the water table in the aquifer below. For infiltration techniques the potential storage capacity ( $S_{pot}$ ) is defined, as a first approximation, by the thickness of the unsaturated zone ( $Z_{unsat}$ ) multiplied by the effective porosity ( $n_e$ ). This static approach does not account for lateral flow and must be considered as a rough approximation of potential storage capacity.

The thickness of the unsaturated zone should be sufficiently high to store substantial water quantities, but not too high to avoid elevated energy costs during later recovery by abstraction wells. The maximum thickness of the unsaturated zone is an economic boundary in the end.

## 2.6 Aquifer pore type and consolidation

Most MAR sites are situated in unconsolidated and porous aquifers. In contrast to fractured and karstified aquifers porous aquifers are usually characterized by higher uniformity of hydraulic properties. Porous aquifers also hold higher potential purification capacities compared to fractured or karstified aquifers. Therefore, porous aquifers are better suited for MAR compared to fractured or karstified aquifers.

## 2.7 Uniformities of hydraulic properties

Heterogeneities of aquifers can be expressed by the variance of K measurements conducted on the same scale of measurement. If e.g. several permeameter tests or infiltrometer tests (each in the same scale) are available the variance of the K values gives a measure of the degree of heterogeneities of the aquifer. Schulze-Makuch et al. (1999) suggests that variance of  $K \leq 0.5 \log_{10}$  the aquifer is considered homogenous, otherwise the geological unit is considered heterogeneous

## 2.8 Aquifer salinity

The quality of the groundwater in the target aquifer will determine the buffer zone necessary between the injected water and the background water. The more different it is, the bigger the buffer zone needs to be. In well injection systems, the aquifers with saline or brackish water will have a buoyancy effect on the bubble of injected water resulting sometimes in abstraction of more saline and denser water in the lower parts of the recovery wells, since the fresh water will float upwards through the aquifer. This loss of recoverable water results in a decrease of efficiency (see definition of efficiency of a MAR system in section 3.3.2). Ward et al. (2009) proposed several ratios that combined give an idea of the efficiency of the system. Two of these ratios are a mixed convection ratio to characterize the density effects during injection and recovery and storage tilt ratio to determine the significance of density-driven flow during storage. They are characterized by the hydraulic conductivity, the density difference, the aquifer thickness and the pumping rate.

## **2.9 Regional hydraulic gradient**

When constructing a recharge basin it is recommended that the elongated side should be perpendicular to the regional groundwater flow direction. This allows the best lateral flow away from the recharge site and ensures best infiltration performance.

The regional groundwater flow should be limited to avoid drift of the injected water outside of the capture zone, since this would mean loss of recoverable freshwater and therefore lower efficiency rates. Among the ratios proposed by Ward et al. (2009) for qualitative prediction of ASR performance there was one based on the lateral drift during storage, dispersive mixing and density effects.

The groundwater withdrawals in the surrounding area should also be taken into account as well as the proximity of sources of contamination.

## **2.10 Topographic slope**

Steep slopes (>5%) do not permit the implementation of infiltration basins, because of generation of water run-off in excess. Flat areas allow high infiltration rates and are most suitable for surface spreading methods. For well injection methods the topographic slope is not critical.

## References

- Dillon, P., and Jimenez, B., 2008, Water reuse via aquifer recharge: intentional and unintentional practices, in Jimenez, B., and Asano, T., eds., *An International Survey of current practice, issues and needs*, IWA Publisher, p. 628.
- Pyne, R. D. G., 2005, *Aquifer storage recovery: a guide to groundwater recharge through wells, ASR systems*.
- Schulze-Makuch, D., Carlson, D. A., Cherkauer, D. S., and Malik, P., 1999, Scale Dependency of Hydraulic Conductivity in Heterogeneous Media: *Ground Water*, v. 37, no. 6, p. 904-919.
- Ward, J. D., Simmons, C. T., Dillon, P. J., and Pavelic, P., 2009, Integrated assessment of lateral flow, density effects and dispersion in aquifer storage and recovery: *Journal of Hydrology*, v. 370, no. 1, p. 83-99.



### 3 Identifying and characterizing optimum conditions for MAR Projects

Christoph Sprenger<sup>1</sup>; Beatriz de la Loma González<sup>2</sup>

1 - Kompetenzzentrum Wasser Berlin, Ciceronstr.24, 10709 Berlin, Germany

2 - KWR Watercycle Research Institute, Groningenhaven 7, 3430 BB Nieuwegein, The Netherlands

Quality assurance: Ester Vilanova (Amphos 21)

#### 3.1 Introduction

This section summarizes technical feasibility from site screening over site characterization to full scale application. This study aims at:

- Summarizing site screening and characterizing methods for surface spreading and well injection techniques
- Identifying robust and cost-effective field and lab scale characterization solutions

The key questions to be addressed are:

- How to determine representative infiltration rates most efficiently
- Does groundwater mounding cause any adverse effects
- Does lateral flow have adverse effects on adjacent wells
- How to determine storage capacity of the subsurface most efficiently

#### 3.2 Identifying and characterization optimum conditions for surface spreading recharge projects

This chapter guides users in gathering the appropriate information to perform a sufficiently rigorous hydrogeological evaluation to minimize potential fatal flaws. Feasibility assessment starts with the collection of available data and screening of the potential site in order to ensuring that the fundamental hydrogeological pre-requisites shown in Table 2-1 are met. To obtain these hydrogeological data, a structured procedure based on the pyramidal approach is recommended (Figure 3-1). Site investigation starts with relatively cheap but numerous field and laboratory testing and continues to more cost-demanding but less numerous tests.

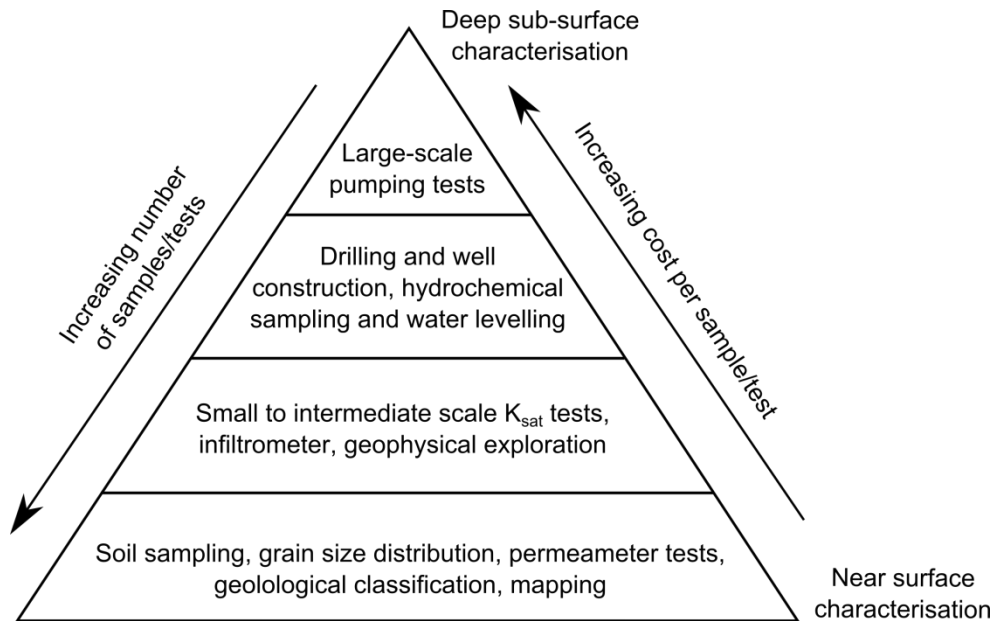

Figure 3-1: Pyramid approach in characterizing optimum conditions for surface spreading projects.

Most of the field and lab scale methods which are introduced here are standard methods and a detailed description of all available methods for determination of the required hydrogeological parameters is beyond the scope of the report. Detailed information can be found in the cited literature and hydrogeology text books such as Fetter (2001), Appelo and Postma (2005) or Freeze and Cherry (1979).

### 3.2.1 Phase I: Near-surface zone characterization (0-3 m below surface)

To investigate a potential site for surface infiltration techniques such as infiltration ponds, shafts or pits it is obvious to start with near surface investigations. Characterization of the soils near or at the ground surface, in the vadose zone, and below the water table is necessary to evaluate groundwater mounding and lateral flow. The objective of phase I is to identify simple and robust methods in order to characterize:

- The range and predominant geological material at near surface (0-3 m below surface)
- The hydraulic properties of the different geological material
- Possible technical constraints (e.g. the risk of groundwater perching on low-K layer in the vadose zone)

The essential component of phase I is the determination of the hydraulic conductivity. Important factors controlling hydraulic conductivity are the soil texture, structure, bulk-density (degree of compaction), grain size distribution, clay mineralogy, and organic content.

Special attention during this phase of investigations should be given to low-K layers. In this context low-K layer can be defined as layers having an estimated hydraulic conductivity of i) less than one order of magnitude the hydraulic conductivity assigned to the overlying materials and ii) less than the sought infiltration rate.

To determine the hydraulic conductivity of the near-surface zone, indirect (grain size distribution of soil samples) and direct laboratory (permeameter test with soil samples) and in-situ (infiltration tests) methods are available.

### 3.2.1.1 Soil sampling

#### Purpose

Soil samples are used to estimate saturated hydraulic conductivity ( $K_{sat}$ ) values from the grain size distribution of disturbed samples or from permeameter tests with undisturbed samples.

#### Execution

The easiest way to collect soil samples from the near-surface is by using simple tools such as spades, shovels, trowels, and scoops. The surface material is removed to the required depth and a stainless steel or plastic scoop is then used to collect the disturbed sample. Disturbed samples are then analysed for their grain size distribution.

With steel cylinders, manually driven to the desired depth and dugged out, undisturbed samples may be obtained. Permeameter tests require undisturbed soil samples representative for the site with diameters which are at least 10 times higher than the grain size. To ensure complete saturation, flow direction should be from bottom to top. An overview for  $K_{sat}$  calculation from grain size distribution curves is given by Vienken and Dietrich (2011) (Table 3-1), each valid for a certain range of unconformity.

Table 3-1: Overview of equations for  $K_{sat}$  calculation (modified from Vienken and Dietrich (2011))

Formula	Unit of K	Relevant parameter	Application range	References
$K = C_H \times d_{10}^2 \times (0.7 + 0.03 \times T)$ $T = \text{temperature}$ $C_H = 1000 \text{ (coefficient)}$	m/d	$d_{10}$ in mm	$U < 5$ $0.1 < d_{10} < 3 \text{ mm}$	Hazen (1893) Chapuis (2004)
$K = C_B \times d_{10}^2$ $C_B = \log \frac{500}{U}$	m/s	$d_{10}$ in mm	$U < 20$ $0.06 < d_{10} < 0.6 \text{ mm}$	Beyer (1964) Vukovic and Soro (1992)
$K = 0.0036 \times d_{20}^{2.3}$	m/s	$d_{20}$ in mm	$U < 5$	Vukovic and Soro (1992)
$K = 0.00357 \times d_{50}^2$	m/s	$d_{50}$ in mm	–	Seelheim (1880)
$K = 10^{0.0005P^2 - 0.12P - 3.59}$	m/s	$P < 0.06 \text{ mm in } \%$	$10\% < P < 60\%$	(Kaubisch, 1986; Kaubisch and Fischer (1985))

### *Evaluation and constraints*

It is important to note that the results derived from equations given in Table 3-1 should be viewed as “order-of-magnitude” estimates and not as exact results. Moreover, grain size distributions from disturbed soil samples represent average values between horizontal ( $K_h$ ) and vertical hydraulic conductivity ( $K_v$ ).

### *Alternative methods*

Hydraulic conductivity can be determined from soil characterization maps. This information may be derived from the European Soil Portal (<http://eusoils.jrc.ec.europa.eu>).

Other standard methods to determine the saturated hydraulic conductivity are e.g. permeameter tests in laboratory, determination of hydraulic conductivity from the moisture content or from soil characteristics.

Measuring of the unsaturated hydraulic conductivity as a function of moisture content of the soil is a fast approach, but requires special probes and equipment and is thus likely to be an order of magnitude more expensive. A less expensive, but also less accurate method is the estimation of the characteristic curve parameters using pedotransfer functions. Software that estimates the capillary pressure saturation and unsaturated hydraulic conductivity function from soil texture and bulk density is given e.g. by Schaap et al. (2001).

#### **3.2.1.2 Small-scale $K_{sat}$ tests**

##### *Purpose*

Infiltrometer tests are oriented toward assessing vertical hydraulic conductivity in-situ.

##### *Execution*

The general procedure is to insert the cylinder a few cm (3 to 10 cm) into the soil. A minimum diameter of 30 cm for homogeneous soils and 80 cm for heterogeneous soils is recommended.

The cylinder is then filled to a certain level with water and water level is kept constant. The ring can be covered to prevent evaporation. The volumetric rate of water added to the ring to maintain a constant head within the ring is measured (inflow rate)

A common problem with infiltration test is the problem of overestimation by divergence or “edge” effects. Bouwer (2002) developed a method to compensate these divergence effects in single ring infiltrometer tests. During this method it is required to measure the wetted front (L) in the subsurface. This can be done by mechanical excavation at the infiltrometer site by e.g. mini-digger or manually.

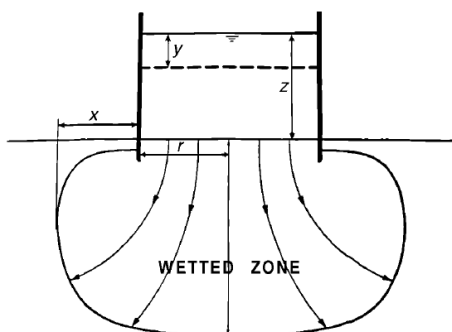

Figure 3-2: Cross-sectional view of geometry and parameter explanations for single-ring infiltrometer based on Bouwer (2002).

### Equations

The approach assumes one-dimensional piston flow conditions and a sharp wetting front. Flow divergence is compensated according to following procedure:

1. Calculate the infiltration rate:

$$i_n = \frac{\text{inflow rate}}{\pi r^2} \quad \text{eq. 1}$$

where:

$r$  = radius of the cylinder

2. Calculate infiltration rate for the wetted area according to:

$$i_w = \frac{i_n \pi r^2}{\pi (r+x)^2} \quad \text{eq. 2}$$

where:

$i_n$  = infiltration rate

$i_w$  = downward flow rate or flux

$x$  = distance of lateral wetting from cylinder wall

3. Calculate saturated hydraulic conductivity:

$$K = \frac{i_w L}{(Z+L-h_{we})} \quad \text{eq. 3}$$

where:

$L$  = depth of wetting front at the end of the test

$Z$  = water height above ground in the cylinder

$h_{we}$  = water-entry value

The term  $h_{we}$  is the water-entry value of the soil which can be estimated by Table 3-3. All other parameters can be measured directly except for  $L$  and  $x$ . The values of  $L$  and  $x$  can be determined by augering or digging down immediately after the end of the infiltration test. Especially in initially dry soil material the wetting front is indicated by strong color contrast (Bouwer, 2002) and can be measured easily. Alternatively, depth of wetting front ( $L$ ) can also be calculated with the accumulated declines ( $y_t$ ) of water level in the cylinder:

$$L = \frac{y_t \pi r^2}{n \pi (r+x)^2} \quad \text{eq. 4}$$

The fillable porosity of soil ( $n$ ) is here estimated from the soil texture and the initial water content of the soil. Bouwer (2002) states that  $n$  is about 0.3 for dry uniform soils, 0.2 for soils with moderate moisture content and 0.1 for wet soils. However, the measurement of  $L$  is favored over the calculation of  $L$ , because of uncertainties associated with the determination of  $n$ .

### *Evaluation and constraints*

The advantages of single-ring infiltrometer compensated by the Bouwer (2002) method compared to double-ring infiltrometer tests are:

- Less water consumption compared to double-ring infiltrometers (important in remote and dry areas)
- More tests in the same time
- Easy to install and maintain

Generally, the larger the wetted area and the longer the test duration, the more robust are the results, because spatial heterogeneities are compensated on the long run. The near-surface small-scale infiltration tests will usually not allow the assessment of percolation for full scale operation. However, the obtained  $K$  from eq.3 can be used as first estimate for the long-term performance of infiltration rate in large and shallow inundated areas without considering clogging (Bouwer, 2002) and water perching on impermeable layers. If the obtained  $K$  is large enough, Bouwer (2002) recommends to continue with bigger test basins (0.2 ha) for long-term flooding. If  $K$  is too low, alternative measures should be considered such as recharge trenches/shafts or well injection techniques.

At soils with boulder-size stones small-scale cylindrical infiltrometers are difficult to install. In some cases substituting the big stones by finer grained material might be possible. Otherwise, it is recommended to go directly for intermediate-scale infiltration tests (Bouwer, 2002). Alternatively, void ratios of the sandy material alone and the sand-boulder mixture are estimated in the laboratory. Disturbed soil samples can be used to determine the bulk hydraulic conductivity ( $K_b$ ) of the sand-gravel mixture according to an empirical formula developed by Bouwer and Rice (1984):

$$K_b = \frac{K_s e_b}{e_s} \quad \text{eq. 5}$$

where:

$K_s$  = hydraulic conductivity of sandy material (derived e.g. from grain size distribution and calculation according to Table 3-1)

$e_b$  = bulk void ratio (volume of voids divided by volume of solids) of sand-boulder mixture

$e_s$  = void ratio of sandy material

### **3.2.1.3 Intermediate-scale $K_{\text{sat}}$ tests**

By using larger infiltration tests (e.g. 2x2 m or larger) divergence effects as observed during small-scale infiltration tests are less significant (Bouwer, 2002), but they are time-demanding (i.e. days to weeks per test) and require large water volumes. In return, intermediate scale infiltration tests allow investigating possible clogging effects and the effect of low conductivity layers deeper down the subsurface and result in more representative  $K$  values.

Intermediate-scale infiltration tests follow the same principles as small-scale tests and can be evaluated with the same equations as discussed above.

Phase I evaluation:

If average near-surface hydraulic conductivity  $K_{sat,v} \geq 10^{-5}$  m/s → continue with phase II (if recharge area < 1000 m<sup>2</sup>), if recharge area > 1000 m<sup>2</sup> conduct intermediate scale infiltration tests and continue with phase II

If average near-surface hydraulic conductivity  $K_{sat,v} < 10^{-5}$  m/s → re-think MAR technique, other MAR techniques such as recharge shafts, pits, soak wells are more feasible, continue with phase II (subsurface characterization)

if low-K layer thickness  $\geq 3$ m → re-think MAR technique, deep well injection might be more feasible, continue with 3.3 (Identifying and characterization optimum conditions for well injection projects)

### 3.2.2 Phase II: Subsurface characterisation

Phase II of site characterization focuses on subsurface investigation methods such as exploratory drilling, monitoring well construction, geophysical investigations, hydrochemical sampling, and pumping tests. Drilling in combination with geophysical exploration aims at assessing the spatial (lateral and vertical) heterogeneities.

The objective of phase II is to identify simple and robust methods in order to characterize:

- Depth-to-water-table
- Total thickness of the unconfined aquifer (depth to bed rock)
- Distribution of the saturated hydraulic conductivity within the aquifer
- Seasonal variation, magnitude, and direction of the prevailing hydraulic gradient

#### 3.2.2.1 Drilling and direct-push

In most cases the establishment of a new MAR sites requires the installation of new wells, either for recovery or for monitoring. A good drilling approach tries to achieve several goals at once, e.g. sampling of geological media and/or installation of monitoring well and/or in-situ hydraulic characterization. One major aim during drilling is characterizing spatial heterogeneities which allow the detection of low permeable layers in the subsoil beyond the scale of phase I investigations. There is a large variety of drilling methods available, each with advantages and disadvantages. A detailed introduction is beyond the scope of this report thus only a brief description is given here. The choice of right method and technology depends very much on the experience and technical equipment available by local drillers and drill engineers, on the required depth and geological situation. Auger methods allow drilling a large number of shallow wells (depending on diameter up to 50m) in relative short time in unconsolidated material. Drill cuttings from auger drillings are however mixed and do not represent a discrete depth. More advanced drilling methods such as sonic drilling or percussion hammer are suitable for larger depths and diameters but require special

equipment and experience. Compared to auger drilling they are faster and allow sampling at defined depths.

During drilling each geological layer should be represented by at least one sample. Attention should be paid to obtaining complete cores or correct correlation with depth in case of loss of material. The borehole logs give information on the aquifer thickness (or if the bed rock was not encountered, a minimum aquifer thickness, e.g. total borehole depth minus depth-to-water table), depth-to-water table at time of drilling, and hydraulic properties of the geological material. Analogous to soil sampling, the sediments should be analyzed for their grain size distribution to i) obtain the K-values for each single layer and ii) identify low-K layers.

The number of drillings which are required to characterize a site representatively depends on the scale of the project and the degree of geological heterogeneities. As a first approach it is recommended to drill one borehole each up- and down gradient of the potential site, which can later be used for monitoring purposes. If no or only minor low-K layers were encountered during drilling, no additional drilling is necessary. Otherwise, monitoring network density must consider the operational scale of the MAR scheme, expected degree of heterogeneities and direction of groundwater flow. Typically, one or two drillings directly at the planned site (depending on dimension) and one or two additional drillings down-gradient should be sufficient. For fractured aquifers, the application of tracer tests might be a useful addition.

- For temporary water sampling and in-situ vertical profiling of hydraulic aquifer properties in unconsolidated aquifers the direct push technology is recommended. This method uses a hollow steel rod which can be equipped with sensor probes and pushed into the subsurface. Sensors are available for a variety of geochemical and geophysical parameters. Main advantages of direct push over conventional drilled monitoring wells are according to USEPA (2005): Lower costs if high density data is required
- Good vertical profiling capabilities
- Faster sampling capability improving on-site decisions

The main limitation of direct push is that it is not applicable in hard rock subsurface or in unconsolidated material with significant amounts of boulders or gravel size rocks. The depth is, depending on the diameter, typically limited to 15 to 30 meters. Probe diameters between 1.5 and 4 inches also limit the sample volume and number of parallel parameter settings. Further information can be found in (USEPA, 1997; USEPA (2005)).

### **3.2.2.2 Pumping test, open-end**

The determination of large scale aquifer properties such as aquifer transmissivity and storage coefficient is obtained by pumping tests or slug tests. Both methods rely on measuring hydraulic heads at a given pump rate in the pumping well and monitoring wells. Pumping tests target the saturated aquifer over its complete thickness (if fully represented by the pumping and monitoring wells) and indicate an average hydraulic conductivity in horizontal direction.

Depending on site conditions, recommended duration of pumping is between 200 (unconsolidated) and 500 hours (fractured aquifers). However, the pumping test should last as long as possible, but at least for



24 hours and 3 days are often regarded to be sufficient (Aitchison-Earl and Smith, 2008). Pumping rate has to be kept constant and measurement of water level recovery after stopping pumping should cover half of the pumping duration. In order to achieve results representative for the aquifer at least one monitoring well is required, three or more are recommended. As a rule of thumb, in unconfined aquifers the distance of the monitoring wells towards each other and the pumping well corresponds to the water level above the aquifer basis and maximum distance should be ten times higher. In any case, distance must be small enough to account for observing significant changes of water level. Large-scale inhomogeneities, as they may be especially present in fractured or karstified aquifers may not be represented even with high density monitoring networks. Continuous water level measurement using automated data logging devices is strongly recommended. Otherwise, frequency of measurements is high (1 minute) during start of the pump test and increased to 1 hour after 5 hours.

For data analysis, several analytical and numerical solutions are available depending on aquifer characteristics. A comprehensive description is given by Kruseman and de Ridder (1994) and shall not be repeated here. For unconfined conditions as targeted by the report, typically the Thiem-Dupuit solution for transient steady-state conditions is applied. The underlying basic assumptions imply that the aquifer is infinitely in spatial extent, homogeneous, isotropic, and has a uniform thickness over the area of influence. Given two monitoring wells in distances  $r_1$  and  $r_2$  to the pumping well with measured drawdowns  $s_1$  and  $s_2$  at steady-state and saturated aquifer thickness  $H$ :

$$K = \frac{2.3 \times Q}{2\pi \times H \times (s_1 - s_2)} \times \log\left(\frac{r_2}{r_1}\right) \quad \text{eq. 6}$$

Numerous software packages are available (open source or licenced). A spreadsheet solution is provided for example by the USGS (Halford and Kuniansky, 2002). In (semi-)arid areas the potential target aquifer may not yield sufficient capacity for long-term pumping at constant rate and thus do not allow for classical pumping tests. In this case the well can be used as a recharge well (soak wells) for a slug test. In a slug test a small volume of water is suddenly removed or alternatively poured into the well and the rise and subsequent fall of water level is monitored. Besides the abandonment of pumping large volumes of water, advantages are the fast advancement and need of lesser equipment. Slug tests are however more prone to interferences and cover only the near range of the well. They may thus be not representative on the large scale and repeated tests at several wells are recommended. For data analysis, the measured heads are usually transferred into a standardized water level recovery curve and the type-curve approach after Theis (for confined aquifers) or Bouwer & Rice (for unconfined aquifers) is applied. The spreadsheet solution stated above is capable of solving slug tests, too.

### 3.2.2.3 Water sampling and leveling

Regional groundwater level measurements through at least one annual cycle help to assess groundwater flow directions and seasonal groundwater fluctuations. Planning criteria for design aspects of the MAR scheme should include seasonal water table and depth-to-water table maps.

Groundwater sampling aims at characterizing the hydrochemistry of the native groundwater in order to establish natural background levels for the target aquifer.

Source water sampling aims at characterizing the hydrochemistry in order to identify possible hazardous compounds related to technical performance (e.g. clogging caused by high TSS) or environmental and human health.

### 3.2.3 Data integration and design aspects

After phase I and phase II evaluation the final step is to integrate the results and to design the required recharge facilities.

#### 3.2.3.1 Vertical hydraulic conductivity

For deciding about the design and dimensions of surface spreading MAR technologies, the saturated vertical hydraulic permeability is one of the most important parameters. Saturated hydraulic conductivity values are typically derived from sediment samples taken from several depths at several locations. K values for any geological media may vary over at least one order of magnitude. Therefore, obtaining accurate measurements for K is critically important.

If hydraulic conductivities are randomly distributed, the best value to use for K would be the harmonic mean of the various K values. In order to obtain a representative or effective hydraulic conductivity ( $K_{eff}$ ), the estimations from different layers at one location can be integrated using the harmonic mean according to:

$$K_{eff} = \frac{d}{\sum \frac{d_i}{K_i}} \quad \text{eq. 7}$$

where:

d = total depth of the regarded soil column (m)

$d_i$  = thickness of layer i (m)

$K_i$  = hydraulic conductivity of layer i (m/s)

If this approach is not feasible, a conservative (low) value for K must be chosen, probably based on the results of several estimates or measurements of K at locations throughout the infiltration area.

The harmonic mean given by equation 6 is the appropriate effective hydraulic conductivity for flow that is perpendicular to stratigraphic layers (Freeze and Cherry, 1979). The distribution of hydraulic conductivity in horizontal direction is important for dissipation of the groundwater mound, but it does not indicate the vertical hydraulic conductivity of low hydraulic conductivity layers. For infiltration basins without any clogging effect and a deep water table the saturated K is equal to the infiltration rate (Bouwer, 1988). If infiltration rate is higher than saturated hydraulic conductivity ponding will occur. That means the harmonic mean of K derived from eq.6 should in the same range magnitude with K values derived from infiltration tests performed under (quasi-)saturated conditions.

Heterogeneity is one of the most salient features in hydrogeology. Thus an effort should be made to capture the hydrogeological variability of the potential site. Hydraulic conductivity is known to be scale-dependent. In heterogeneous porous media K increases by half an order of magnitude with each order of magnitude increase in scale of measurement (Schulze-Makuch et al., 1999). Fractured or karstified target aquifers may show much larger scale dependencies and have to be treated with special caution. The scale of measurement can be expressed by the volume of media which was tested. Measure of scale and typical ranges of scale for various hydrogeological tests are shown in Table 3-2.

Table 3-2: Measure of scale and typical scale ranges for hydrogeological tests (modified after Schulze-Makuch et al. (1999)).

Type of test	Measure of scale	Typical range of scale (m <sup>3</sup> )
Grain size distribution, permeameter	V <sub>s</sub>	1x10 <sup>-4</sup> – 5x10 <sup>-4</sup>
Infiltrometer (single ring, open-end)	V <sub>w</sub> /n <sub>e</sub>	1x10 <sup>-3</sup> – 1x10 <sup>-2</sup>
Single and multiple well pumping tests	Qt/n <sub>e</sub>	1x10 <sup>1</sup> – 1x10 <sup>4</sup>
Local/regional numerical flow models	L <sub>f</sub> L <sub>t</sub> B	1x10 <sup>2</sup> – 1x10 <sup>6</sup>

V<sub>s</sub> = volume of rock or sediment sample (m<sup>3</sup>)

V<sub>w</sub> = volume of water introduced or removed during recorded time interval (m<sup>3</sup>)

B = thickness of geological media (m)

L<sub>f</sub> = flow distance (m)

L<sub>t</sub> = transversal spreading distance, assumed to be L<sub>f</sub>/10 (m)

Q = pumping rate (m<sup>3</sup>/h)

t = time (h)

n<sub>e</sub> = effective porosity (-)

Typical scales of MAR systems are in a range comparable to numerical flow models or well pumping tests. Due to the scale dependency, each K value should be weighted according to the scale at which it was determined. Generally, field derived K values are considered to be more meaningful compared to laboratory derived K values. Field tests are preferable to laboratory tests because they encompass the scale of interest and determine properties of undisturbed soils, and lab tests are more reliable than estimates based solely on soil types derived from soil classification maps.

### 3.2.3.2 Infiltration rate (hydraulic loading rate)

The infiltration rate for a given pond or trench is calculated by the product of the saturated vertical hydraulic conductivity and the hydraulic gradient. There are two end-points for estimating the hydraulic gradient: i) sites with vadose zone > 30 m and ii) sites with vadose zone ≤ 30m.

At sites with thickness of vadose zone > 30m the infiltration rate can be approximated by the Green-Ampt equation. The Green-Ampt equation was developed to calculate the infiltration rate (V<sub>i</sub>) from a ponded surface (e.g. infiltration basin) into a deep homogeneous porous media with uniform initial water content. The Green-Ampt model has been found to apply best to infiltration into initially dry, coarse textured media which exhibit a sharp wetting front (Green and Ampt, 1911):

$$V_i = K \left( \frac{H_w + L_f - h_{we}}{L_f} \right) \quad \text{eq. 8}$$

where:

$V_i$  = the infiltration rate or hydraulic loading rate (m/s),

$K$  = hydraulic conductivity (m/s), e.g. derived from eq.6 and translated to unsaturated conditions (see Bouwer (1978))

$H_w$  = depth of water in the pond or infiltration basin (m)

$L_f$  = depth of the wetting front below the bottom of the pond (m)

$h_{we}$  = suction or negative pressure head at the wetting front (m). Approximately equal to the air entry pressure or bubbling pressure

Because of entrapped air, unsaturated  $K$  ( $K_{unsat}$ ) values are lower than saturated  $K$ . The estimation of  $K_{unsat}$  is expensive and time consuming. Values of  $h_{we}$  describe the suction at the wetting front (negative pressure head). Typical values of  $h_{we}$  along with other important hydraulic properties for various soils can be found in Table 3-3.

**Table 3-3: Magnitude of total porosity ( $n_{tot}$ ), effective porosity ( $n_e$ ), hydraulic conductivity ( $K$ ) and suction head ( $h_{we}$ ) of various unconsolidated aquifer materials (after Hölting and Coldewey (2009) and Bouwer (2002)).**

Aquifer material	Total porosity, $n_{tot}$ (%)	Effective porosity, $n_e$ (%)	Hydraulic conductivity, $K_{sat}$ (m/s)	Water-entry value or suction head, $h_{we}$ (cm)
sandy Gravel	25-35	20-25	$3 \times 10^{-3} - 5 \times 10^{-4}$	-
Gravel Sand	28-35	15-20	$1 \times 10^{-3} - 2 \times 10^{-4}$	-5
Medium Sand	30-38	10-15	$4 \times 10^{-4} - 1 \times 10^{-4}$	-10
Silty Sand	33-40	8-12	$2 \times 10^{-4} - 1 \times 10^{-5}$	-15
Sandy Silt	35-45	5-10	$5 \times 10^{-5} - 1 \times 10^{-6}$	-25
Clay Silt	40-55	3-8	$5 \times 10^{-6} - 5 \times 10^{-8}$	-35
Silt Clay	45-65	2-5	$\sim 10^{-8}$	-

Alternatively, estimations for  $K_{\text{unsat}}$  can be made using the equation developed by van Genuchten (1980) for different soil moisture values. Formulations that employ computer calculations have been developed that use physical soil properties as input (Schaap and van Genuchten 2001). For the sake of simplicity Bouwer (1978) refers to  $K/K_{\text{sat}}$  ratios of 0.5 for sandy soils and 0.25 for clays.

### 3.2.3.3 Groundwater mounding

Groundwater mounding below infiltration basins occurs when infiltration rates exceed the capability of subsurface material to transport the water in vertical and horizontal directions. Groundwater mounding increases with decreasing hydraulic conductivity, and with decreasing thickness of the vadose zone and the occurrence of low-K layers. Depending on site-specific conditions different levels of evaluation are required to assess the effect of groundwater mounding. At sites with shallow groundwater table and low hydraulic conductivity the groundwater mound eventually will reach the near surface and thereby reducing the hydraulic gradient and hence also the infiltration rate significantly. Therefore, estimation of infiltration rates only based on saturated hydraulic conductivities may overlook mounding effects.

At sites with thickness of the vadose zone > 30m and without significant low-K layer the groundwater mounding can be evaluated by the Hantush (1967) solution (eq.10).

If layers with low hydraulic conductivity are detected during phase I or phase II investigation, perched groundwater effects must be considered. The analytical solution as shown by Bouwer (2002) is used for cases when a low-K layer in the vadose zone is detected. This solution is valid for long rectangular recharge basin or under circular recharge basins. Variable water saturation and capillary fringe effects are neglected:

$$L_p = L_r \frac{\frac{i}{K_r} - 1}{1 - \frac{i}{K_s}} \quad \text{eq. 9}$$

where:

$L_p$  = equilibrium height of perched mound above low-K layer (m)

$L_r$  = thickness of low-K layer (m)

$i$  = infiltration rate (m/d)

$K_r$  = hydraulic conductivity of low-K layer (m/d)

$K_s$  = hydraulic conductivity of layer above low-K layer (m/d)

In some cases perched groundwater may have a positive effect, as it prolongs the treatment time in the subsurface.

To calculate groundwater mounding in lateral extent, a widespread accepted analytical solution was developed by Hantush (1967). This approach assumes a water-table aquifer of infinite extent and finite thickness with a horizontal, impermeable base. It includes horizontal flow and neglects changes in transmissivity due to changing water head and is valid for rectangular and circular recharge areas. The Hantush formula for calculation of groundwater mounding below a rectangular recharge area is given by:

$$h^2 - h_i^2 = \left(\frac{w}{2k}\right) (vt) \left\{ S * \left(\frac{l+x}{\sqrt{4vt}}, \frac{a+y}{\sqrt{4vt}}\right) + S * \left(\frac{l+x}{\sqrt{4vt}}, \frac{a-y}{\sqrt{4vt}}\right) + S * \left(\frac{l-x}{\sqrt{4vt}}, \frac{a+y}{\sqrt{4vt}}\right) + S * \left(\frac{l-x}{\sqrt{4vt}}, \frac{a-y}{\sqrt{4vt}}\right) \right\}$$

eq. 10

where  $S * (\alpha, \beta) = \int_0^1 \operatorname{erf}\left(\frac{\alpha}{\sqrt{\tau}}\right) \operatorname{erf}\left(\frac{\beta}{\sqrt{\tau}}\right) d\tau$

where:

$h$  = head at a given time after recharge begins

$h_i$  = initial head (height of the water table above the base of the aquifer)

$w$  = recharge (infiltration) rate

$K$  = horizontal hydraulic conductivity

$v$  = diffusivity, where  $v = Kb/Sy$

$\underline{b}$  = average aquifer thickness

$S_y$  = specific yield

$t$  = time elapse since recharge began

$l$  = half-length of the recharge basin

$a$  = half-width of the recharge basin

$x$  = distance from the center of the recharge basin in the x direction

$y$  = distance from the center of the recharge basin in the y direction

$$\alpha = \frac{l+x}{\sqrt{4vt}} \text{ or } \frac{l-x}{\sqrt{4vt}}$$

$$\beta = \frac{a+y}{\sqrt{4vt}} \text{ or } \frac{a-y}{\sqrt{4vt}}$$

$\tau$  = dummy variable of integration and

$\operatorname{erf}$  = error function

The Hantush solution does not consider hydraulic anisotropy and conservative results are achieved by using the vertical K value. The equation is relative complex and has been translated into R language (R Core Team (2014)). The R-package can be downloaded under <http://cran.r-project.org/web/packages/kwb.hantush/index.html>. Excel spreadsheet solutions from other authors are also readily available in the internet.

If the Hantush solution is used to calculate long-term groundwater mounding, e.g. in water banking projects with deep groundwater levels, the transmissivity must be adapted to the increase of transmissivity due to rising water table. Otherwise, the Hantush solution overestimates the groundwater mound development (Bouwer, 2002).

Analytical solutions for the calculation of groundwater mounding effects right below the recharge area are readily available. For elongated basins, when basin length > 5 × basin width, the following formula is valid (Bouwer et al. 1999):

$$H_c - H_n = \frac{iW}{2T} \left( \frac{W}{4} + L_n \right) \quad \text{eq. 11}$$

where:

$L_n$  = distance between edge of recharge area and control area

$W$  = width of recharge area

$i$  = infiltration rate

Bouwer et al. (1999) developed also an analytical solution for round or square recharge ponds, where the groundwater flows radially away from the point/area of recharge. The ultimate or steady-state height of the groundwater mound right below of the centre of the recharge pond is calculated according to (Bouwer et al., 1999):

$$H_c - H_n = \frac{V_i R^2}{4T} \left( 1 + 2 \ln \frac{R_n}{R} \right) \quad \text{eq. 12}$$

where:

$R$  = radius or equivalent radius of the recharge area (m)

$R_n$  = distance from the centre of the infiltration pond to the control area (m)

$H_c$  = height of groundwater mound in the centre of recharge area (m)

$H_n$  = height of water table in control area (m)

$V_i$  = average infiltration rate (total recharge divided by total area) (m/s)

$T$  = transmissivity of the aquifer (m<sup>2</sup>/s)

Control area is here defined as the area where the groundwater table is stable. The value of transmissivity in eq. 10 and eq. 11 must reflect the average transmissivity of the aquifer at the steady-state stage of the mound. If the groundwater mounding height > thickness of the vadose zone, preventive measures such as increasing the recharge area or decreasing the distance to the control area (e.g. by designing recovery wells closer to the recharge area).

#### 3.2.3.4 Design aspects

With the first approximation of infiltration rates and the groundwater mounding height a design concept can be developed. To minimize construction costs and land area required, recharge facilities are designed to accept and store the required volumes most efficiently. Basin shapes can be round, square or elongated. Generally, elongated basins achieve higher hydraulic loading rates than round or square type basins. Computer simulations described in Massmann et al. (2003) suggest that ponds with large aspect ratios (defined as pond length divided by pond width) have higher infiltration rates than ponds with lower aspect ratios.

For safety reasons recharge basins are often designed to have not more than 1 to 1.5 m of standing water. Therefore, ponding height (i.e.  $H_w$  in Green-Ampt solution) is constrained by this safety measure, but may be modified in other cases.

Infiltration basins do not necessarily require unsaturated conditions to be present below the basin. Attenuation may rely on processes in the saturated zone alone, but in praxis also "normal" infiltration basins are characterized by changes in saturated/unsaturated conditions. SAT systems, which involve intermittent infiltration of treated sewage, require vadose conditions to be present as an additional safety barrier for contaminant attenuation before reaching the water table. Due to changing water saturation and intermittent infiltration rates unsaturated flow is difficult to assess and recent research has shown that

preferential flow (and transport) is much more common under unsaturated conditions (Lassabatere et al., 2014). Conservative estimate of travel time ( $t_u$ ) based on preferential flow assumption is given by:

$$t_u = \frac{d_u n_e}{K_{sat,v}} \quad \text{eq. 13}$$

where:

$d_u$  = minimum depth to the mounded water table below the recharge site (m)

$n_e$  = effective porosity (-)

$K_{sat,v}$  = saturated, vertical hydraulic conductivity (m/d)

SAT systems (but also infiltration systems with conventional source water) are often operated in alternating dry and wet cycles in order to i) maintain infiltration rates ii) control redox conditions in the subsurface and iii) maximize nitrification and nitrogen removal. During dry phase the recharge facility also allow for regular maintenance (e.g. mechanical cleaning, sand washing). Time intervals for wet/dry cycles vary from few days to few weeks and depend on purpose and site specifics. In general, longer dry phases enables oxygen to aerate the subsurface at greater depths, while longer wet cycles increases the potential of adsorption for mostly cations (e.g. ammonia). However, operational practice must be based on local site characteristics but also weather factors including temperature, precipitation and solar incidence.

If possible the recharge area should be oriented perpendicular to regional groundwater flow direction. Once the designer obtains values for vertical and horizontal K, the vertical K values can be used in the Hantush solution to obtain a conservative estimate of mound height, and an estimate of the lateral mound extent. A more rigorous analysis requires use of numerical models to estimate mound height and lateral extent.

### 3.2.3.5 Correction for temperature dependencies of hydraulic conductivity

Increasing water temperature will cause an increase of hydraulic conductivity due to a decrease of water viscosity. Temperature ranges encountered in field may vary from slightly above 0°C to maximum 40°C in some cases. Temperature effects on water density, within the expected temperature range, will have only marginally effects and can be neglected. At sites with large seasonal or diurnal temperature variations the temperature-dependent change of water viscosity will however have a significant impact on infiltration rates.

$$K = K_i \frac{g}{\mu} \quad \text{eq. 14}$$

where:

K = hydraulic conductivity (m/s)

$K_i$  = intrinsic (function of particle size distribution) (m/s)

G = gravity ( $g/s^2$ )



$\mu$  = dynamic viscosity (Pa s)

Changes of dynamic viscosity as a function of temperature are shown in Table 3-4.

Table 3-4: Dynamic viscosity of water as a function of temperature.

Temperature (°C)	Dynamic viscosity ( $10^{-3}$ Pa × s)
5	1.519
10	1.308
15	1.140
20	1.002
30	0.7978
40	0.6531

Temperatures increase for instance from 15°C to 30°C would therefore increase the dynamic viscosity of the water by 30% and thereby decrease hydraulic conductivity proportionally. Under field conditions water temperatures in the subsurface are not uniformly distributed and are influenced by conductive heat transport with the surrounding media. In field experiments it was shown that infiltration rates increased by 24% over a diurnal temperature change from 16° to 30°C (Jaynes, 1990) which is slightly below of what is expected from theoretical considerations. Hence, recharge systems based on a certain hydraulic loading rate, should be designed on the basis of low temperature conditions (e.g. winter or night) when infiltration rates are lowest.

### 3.2.3.6 Filtration layer in the pond bed

The bed of the infiltration basins is usually filled with two layers of quartz material of minimum 80% SiO<sub>2</sub> content. The filter layer on top aims to ensure spatially constant infiltration rates, decreases maintenance efforts, and acts as a filter for cleaning the source water. Clogging, which is in most cases unavoidable, will develop mainly on the surface and allows that filter layer material can be removed, washed and filled back in case of infiltration rates decreasing below a certain threshold. The supporting bottom layer below aims to avoid “sweeping” of filter layer material to the aquifer. Grain size should be about three times larger than filter layer material. Grain size distribution for both layers are characterised by a steep slope, expressed by the uniformity coefficient (see also Table 3-1). An example of technical specifications of the filter layer material is shown in Table 3-5.

Table 3-5: Filter layer thickness and grain size distribution according to DIN EN 12904.

	Filter layer	Supporting layer
Thickness, min-max (m)	0.4 - 2	0.1 – 0.5
Grain size, d10-d90 (mm)	0.15-0.3	×3
Grain size, min-max (mm)	0.1-0.35	×3
Uniformity, d60/d10 (-)	~2.3	~2.3

### 3.2.3.7 Numerical models

In contrast to analytical solutions, numerical models can be adapted to a wide range of site-specific conditions and problem statements. A large number of numerical models have been used to analyze various MAR systems ranging from basic hydraulic problems (Neumann et al., 2004) to complex temperature-dependent redox zonation and associated contaminant removal (Greskowiak et al., 2006; Henzler et al., 2014). On the other hand numerical modelling often suffers from high degree of complexity and a high demand of site-specific data and is therefore not always recommended to be utilised.

### 3.3 Identifying and characterization optimum conditions for well injection projects

As discussed in the previous chapter surface recharge requires the soil between the ground surface and the water table to be relatively highly permeable and there needs to be sufficient land surface available at reasonable cost to build an open recharge basin. These requirements well injection MAR systems do not have. Moreover, whereas the use of surface recharge is limited to unconfined aquifers, well injection MAR systems can take advantage of the presence of suitable permeable confined aquifers at greater depths. However, due to the increased entry velocity of recharge wells compared to open basins, this method is associated with higher clogging rates which involve higher maintenance and water-pretreatment costs to minimize the plugging, or clogging of wells. When recovery of the injected water is the goal of a well injection MAR systems, it can be done through wells or drains separated a certain distance of the injection wells or through recovery of the water by using the same well as used for injection. This is called Aquifer Storage and Recovery (ASR), where the water is injected in and recovered from the same well. This allows the MAR system to be located in areas with poor native water quality and it usually involves less pre-treatment costs, making it more cost-efficient (Pyne, 2005). When the objective of the aquifer recharge is to blend the injected water with the native groundwater then there are the single-purpose wells (in contrast with the dual-purpose wells in ASR) the best choice, these systems are also called ASTR (Aquifer Storage Transfer Recovery).

Well injection MAR's can be applied not only to store and produce drinking water but also for agricultural water supply, by storing water in the ground where the space above-ground is limited, favoured to use for other purposes, or to store agricultural runoff avoiding the eutrophication of lakes

and reservoirs through nutrient reduction along the underground. Well injection MAR can be combined with surface spreading for an expansion of the water facilities, or with production well fields where the groundwater levels are being depleted and the yield is limited due to environmental reasons. This is especially true when there are big seasonal variations in the water demand, since there is not always sufficient space above ground to cover the peak demands, for instance, in summer for some coastal cities. It is also useful to prevent salt intrusion in coastal areas where surface spreading methods are not viable or to avoid land subsidence by increasing the groundwater levels with water injection.

### **3.3.1 Characterization of optimum conditions for a well injection MAR system**

#### **a) Target aquifer properties**

The ideal target aquifer for a well injection MAR system is a semi-confined or confined aquifer. The location of the well injection MAR system should have logistic access, with enough space for the drilling activities and means to dispose water flows from the test wells during development. The performance of a well injection MAR system will be highly dependent on hydrogeological factors that control mixing and migration of the injected water. Therefore, one of the key points when planning the implementation of an ASR or ASTR system is choosing the right location and target aquifer, as this selection will have a large influence on the efficiency of the system. Deciding whether a location fulfills the optimum conditions required for a well injection MAR system can be done following these steps:

1. Translation of water demand into an approximate target storage volume and injection/abstraction rates of the water excesses and deficiencies (volume/time) that will be addressed by the MAR system; based on this, is a well injection system the most cost-effective option for this target?
2. Finding a potential AS(T)R site according to the target storage volume, where testing can be performed for data-collection and modeling purposes. Designate the location through proximity to water sources, land availability, permitting legislation, etc. A first analysis of the costs plays a role in the selection of the study area when comparing distances to source of water and distribution, possible pre-treatment costs, etc.
3. Preliminary hydrogeological investigation: Compilation and interpretation of all the hydrogeological information available of the study area (geology, geochemistry and water quality). Based on these estimate possible recovered water quality, well-clogging potential, etc.
4. If an aquifer is potentially viable but the hydrogeological data available and collected is not very detailed (with the hydraulic properties defined in point 6 and water quality defined in point 7), then it is recommended to drill an exploratory or monitoring well.
5. Drilling of an exploratory well. The selection of a drilling method can be based on what was discussed by Driscoll (1986), the drilling will provide preliminary geological and water quality data. During the drilling core samples are taken that will give information on the porosity, permeability and geochemistry of the aquifer. The geochemistry plays an important role in exchange processes with the injected water and leaching of trace elements (such as arsenic). A subsequent borehole

geophysical logging gives information on the formations resistivity, materials and groundwater. This will give an insight on the formation's capability of holding an ASR system and its efficiency.

6. Conducting performance tests to calculate the hydraulic properties described below. A pumping test should be performed on the exploratory well the type of test will depend on the type of aquifer, this together with different aquifer testing methods is discussed by Stallman (1971). The methodology of the pumping test is further discussed by Missimer (2009) and by Kruseman and Ridder (1990). The pumping test gives information as to the well capacity and the following relevant hydraulic coefficients:

Transmissivity: is a function of the thickness and permeability or conductivity of the aquifer. The transmissivity should stay between some limits since a very high transmissivity (T) can mean easy migration of the injected bubble in the presence of significant background flow and a low T could mean high pumping costs and a higher sensitivity for clogging. The preferred T range is between 248.4 and 1836 m<sup>2</sup>/d (Missimer, 2009).

$$T = kH$$

where

$k$  (m/d) = hydraulic conductivity of the aquifer (m/day)

$H$  = thickness (m) of the aquifer

The desired aquifer thickness for low injection rates is between 15 to 18m and for high injection rates more than 30m (Missimer, 2009) Leakage: is defined as the ratio of an aquifers vertical hydraulic conductivity to the saturated thickness of the aquifer and describes the amount of water lost through vertical transport from the aquifer through its confining or semi-confining layers. The preferred value is lower than 1.3/day (Missimer, 2009).

Aquifer heterogeneity: dual porosity aquifers (aquifers whose microporous nature provides very large but relatively immobile storage (matrix) and flow through fractures) are less suited for aquifer recharge since the water would follow preferential paths (fractures).

7. Collection of water samples from the target aquifer and from above and below the aquifer if possible. The water quality of the target aquifer will define the boundary of the recharged water and the interactions with it. The redox reactions that take place in the aquifer can lead to clogging by oxidation of chemically reduced mineral phases (such as iron and manganese). The pH of the native groundwater is relevant as it can mean leaching of metals from the aquifer when the injected water has very different pH values. Therefore at least the major cations, anions, salinity and physical parameters should be analyzed.
8. Develop hydraulic, transport, and reactive models (such as PHREEQC) to forecast the possible impacts of the MAR system in the surrounding area. Column leaching experiments are also very informative.
9. Evaluation of potential pre- and post-treatment options.

The subsequent step, after all the previous tests are successful is to develop and test a pilot ASR system, where well cuttings are collected and described, geophysical logs are run and a step-drawdown test is conducted to determine the potential well yield, a well performance test should also be run. The AS(T)R should be run while monitoring water levels and quality in the storage zone for several injection and recovery cycles. Examples of cycle test programs and pilot set-ups can be found in Pyne (2005) and Dillon (2002).

b) Rechargeable water source

Information should be available on the source water flow available, the temporal variability in flow rate and the trends in time. The water quality has to be thoroughly analyzed and should also be associated with the temporal variability of the flow. For the preliminary feasibility assessment of a well injection the source water quality should be compared with the water quality standards. This can be compromised by parameters like nitrate, sulfate, silt, turbidity, manganese, algae, trihalometanes, haloacetic acid, etc. Treatment costs are usually related to total organic carbon (TOC) concentrations and maintenance costs are also related to the pH, iron and suspended solids content. Examples of parameter sets analyzed in recharge waters of different ASR systems can be found in Pyne (2005) and in Dillon (2002).

c) Well field design and recovery efficiency

Once the feasibility study and the field test program are performed, the ASR well field can be expanded. Pyne (2005) describes in detail the design of ASR well fields covering the drilling methods, well casing, wellheads and downhole equipment and the well field configuration. When using the well injection for future recovery of the water, every step in this decision process is made towards the maximum and sustainable recovery efficiency of the recharged water.

*“The recovery efficiency of an ASR is defined as the percentage of the water volume stored in an operating cycle that is subsequently recovered in the same cycle while meeting a target water quality criterion in the recovered water.”(Pyne, 2005).*

This definition implies that an ASR considered 100% efficient might be recovering the same volume of water that was injected but it can be a mix of recharge and native water, so far as it complies with the desired recovered water quality. The recovery efficiency is thus the ratio of the recovered water to the water injected:

$$RE = \frac{V_r}{V_i}$$

Where RE is recovery efficiency,  $V_r$  is the volume of freshwater recovered with a satisfying quality [ $L^3$ ] and  $V_i$  is the volume of freshwater injected [ $L^3$ ].

d) Response of the aquifer to the injection

The aquifer reacts to the injection of water differently depending on the distance to the recharge point and the native groundwater quality. The first few meters of the aquifer surrounding the recharge facility are called the recharge proximal aquifer zone. This zone is where most of the

chemical reactions takes place and the detention times are shortest (Stuyfzand, 2011). The next zone that the water passes through is the distant aquifer zone and it is situated between the recharge proximal zone and the zone surrounding the recovery system which is called the discharge proximal zone. The distant aquifer zone is usually defined by the displacement of native groundwater, with the processes that this involves: cation exchange, oxidation of chemically reduced mineral phases, precipitation and dissolution of minerals, biodegradation of organic micropollutants etc.. The discharge proximal zone zone is usually defined by removal of fine particles from the aquifer and well clogging. Per zone different redox environments develop, and depending on the type of well injection MAR system and recovery, this will vary. Figure 3-3 shows the redox zonation of an ASTR after 2 years of continuous infiltration and distant recovery in deep anoxic water. The water passes through oxic and suboxic conditions (well proximal zone) to anoxic conditions in the distant aquifer and discharge proximal zones. Whereas in an ASR in a deep anoxic location there is an anoxic area in the well proximal zone during storage that travels from the well outwards leaving behind a suboxic zone and that during recovery, when passing through this suboxic zone gets depleted in  $Fe^{2+}$ ,  $Mn^{2+}$ ,  $NH_4^+$ , and  $PO_4^{2-}$ .

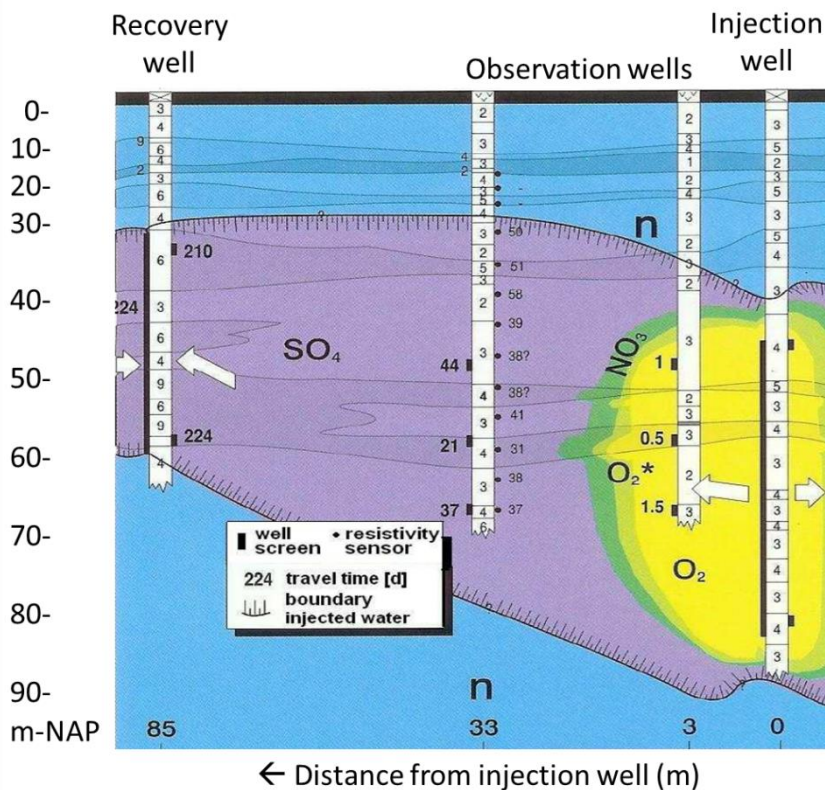

Figure 3-3: Cross-section from a Dutch ASTR pilot, located in Eastern Netherlands (St. Jans klooster) showing the redox zonation after 2 years of continued injection: O<sub>2</sub>=oxic, O<sub>2</sub>\*=penoxic, NO<sub>3</sub>=suboxic, SO<sub>4</sub>=anoxic, n= native deep anoxic groundwater. (Numbers within soil column indicate median grain size -1 =100, 9 = 900 μm-; numbers next to well screens and resistivity sensors indicate travel time [d]). Modified from (Stuyfzand, 2011).

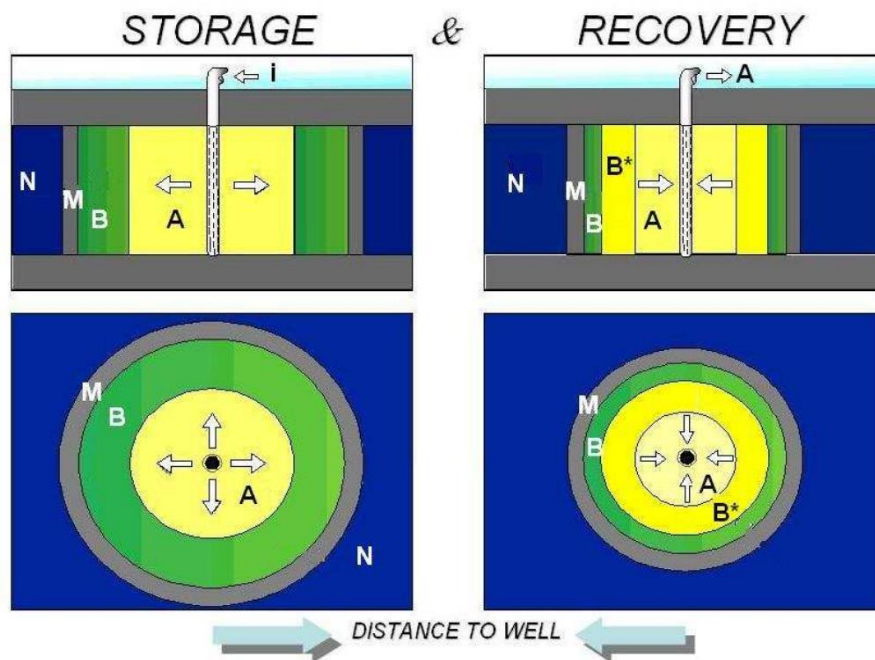

Figure 3-4: Schematic redox zonation of an ASR system in an originally deep anoxic aquifer. *i* = oxic infiltration water; A = (sub)oxic infiltrate; B = anoxic infiltrate in Buffer zone; B\* = anoxic infiltrate from buffer zone but strongly depleted in Fe<sup>2+</sup>, Mn<sup>2+</sup>, NH<sub>4</sub><sup>+</sup> and PO<sub>4</sub><sup>3-</sup> by sorption to newly formed ferrihydrite; M = mixture of B and N; N = deep anoxic native groundwater. After (Stuyfzand, 2011).

### 3.3.2 Solutions to obstacles to the implementation of well injection MAR systems: Dutch Examples

Aquifer Storage (and recovery) of fresh water has been applied widely and successfully in fresh water aquifers but in saline or heterogenous aquifers the storage of freshwater has proved to be challenging due to mixing with the native water and the migration of the injected water due to lateral flow and density driven flow (Missimer et al., 2002).

In addition, aquifer storage is not only desired for fresh pretreated water but also for untreated groundwater storage, reclaimed water or to be combined with a desalination plant. These alternatives can be partly the solution to an increasing pressure in the water demands but they involve technical difficulties. These difficulties are being addressed by the following newly developed techniques:

#### 3.3.2.1 Multiple penetrating wells

ASR of freshwater in coastal areas where freshwater demands are high and groundwater is brackish or saline can be a cost-effective technique for fresh water supply in periods of drought. But due to lateral groundwater flow and buoyancy effects this method can become inefficient. Buoyancy effects result in a displacement of the fresh water by saline water that enters the lower parts of the ASR during early recovery (Figure 3-5). This lowers the fraction of the injected water that is recovered, and so does thus the efficiency of the system, as defined in the previous chapter.

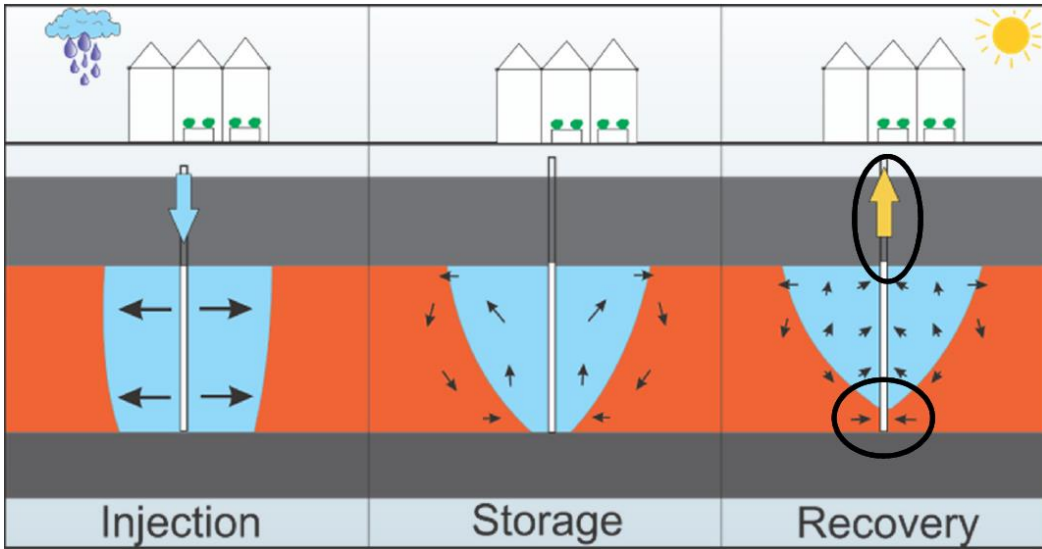

Figure 3-5: Phases of an ASR in coastal areas: injection, storage and recovery. The graph shows the lateral flow and buoyancy effects during recovery.

This problem can be addressed through optimization of the well design by enabling recovery at the top of the aquifer combined with extra injection at deeper parts. The use of multiple partially penetrating wells in a single borehole (MPPW) allows preferential injection and closing off well segments if salinization occurs. This system is being applied in the Netherlands in different locations at small scale, usually related to greenhouses, where the roof-water surpluses are being injected and recovered when needed. A schematic cross-section of the set-up of such a system can be found in Figure 3-6. The effectiveness in improving the efficiency of a small-scale ASR system suffering from buoyancy effects has been shown by Zuurbier et al. (2014b)



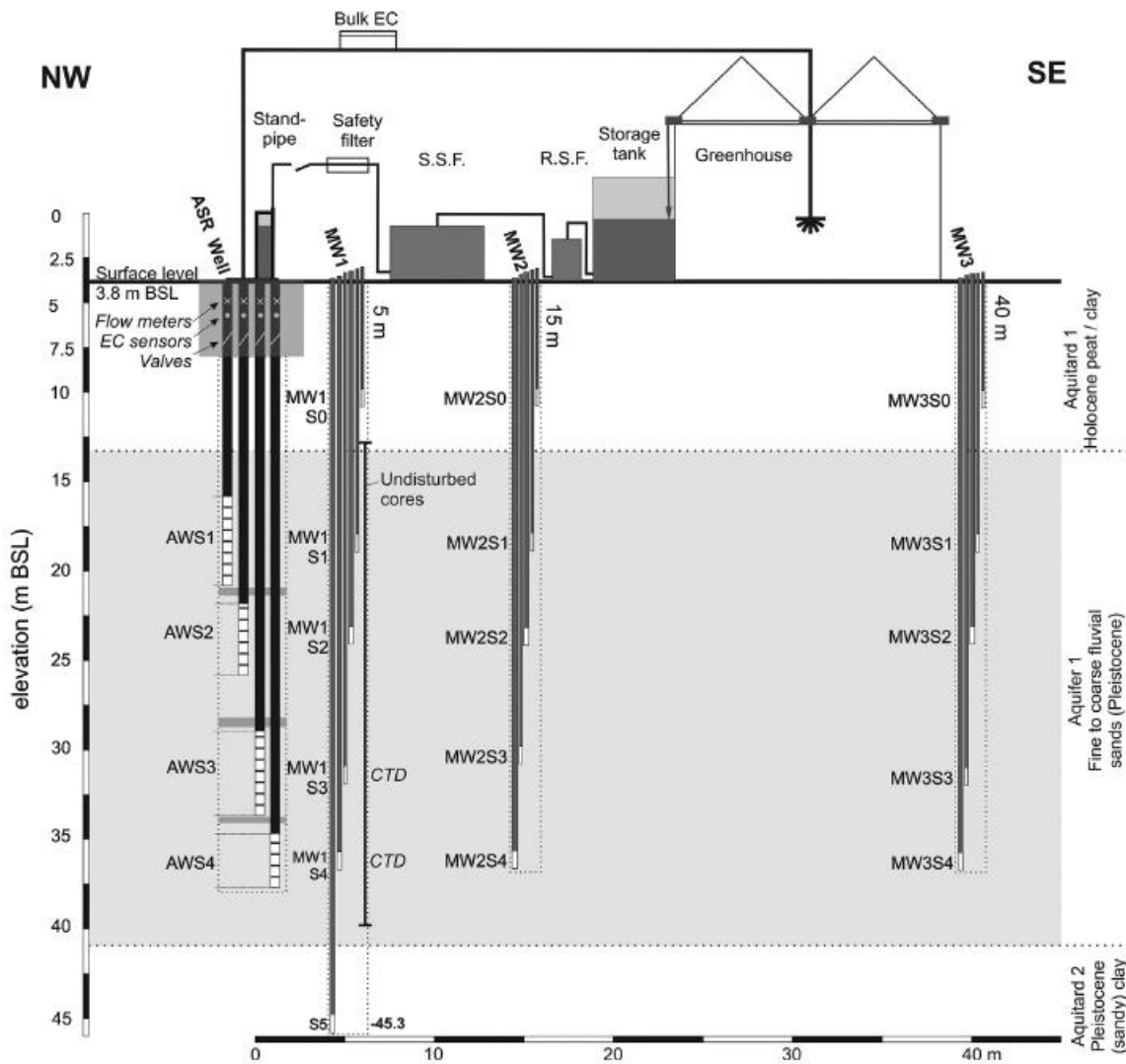

Figure 3-6: Setup of an ASR field trial in Nootdorp, in the South of The Hague, with chloride concentrations in the target aquifer around 1000 mg/L. MW = monitoring well, CTD = electric conductivity, temperature, and pressure datalogger, R.S.F. = rapid sand filtration, S.S.F. = slow sand filtration. Taken from Zuurbier et al. (2014b).

In the pilot study performed by Zuurbier et al. (2014b) the efficiency, or recovered freshwater, of the first cycle increased from 14.7% to 40.2% when using MPPW instead of fully penetrating well (FPW) or to 30.2% when using singles partially penetrating well (SPPW). During subsequent cycles the modelled efficiency increased up to 60% in the case of MPPW, 35% in the case of single penetrating well (SPPW), and 20% in the case of a fully penetrating well (FPW). Therefore, the use of MPPW enables freshwater management in brackish coastal aquifers in a more optimized way than through conventional ASR.

### 3.3.2.2 The Freshmaker

When managing fresh water in saline aquifers that are thin and unconfined the use of multiple partially penetrating wells might prove insufficient (Zuurbier et al., 2013; Zuurbier et al., 2014b) . A

new technique developed by KWR (The Netherlands) based on the use of horizontal directionally drilled wells tackles this problem. It is based on the combination of two horizontally drilled wells: a shallow one that abstracts fresh groundwater when needed (and injects when not needed) and a deeper one that abstracts saltwater continuously, intercepting it and avoiding salinization of the upper (fresh) well (Figure 3-7).

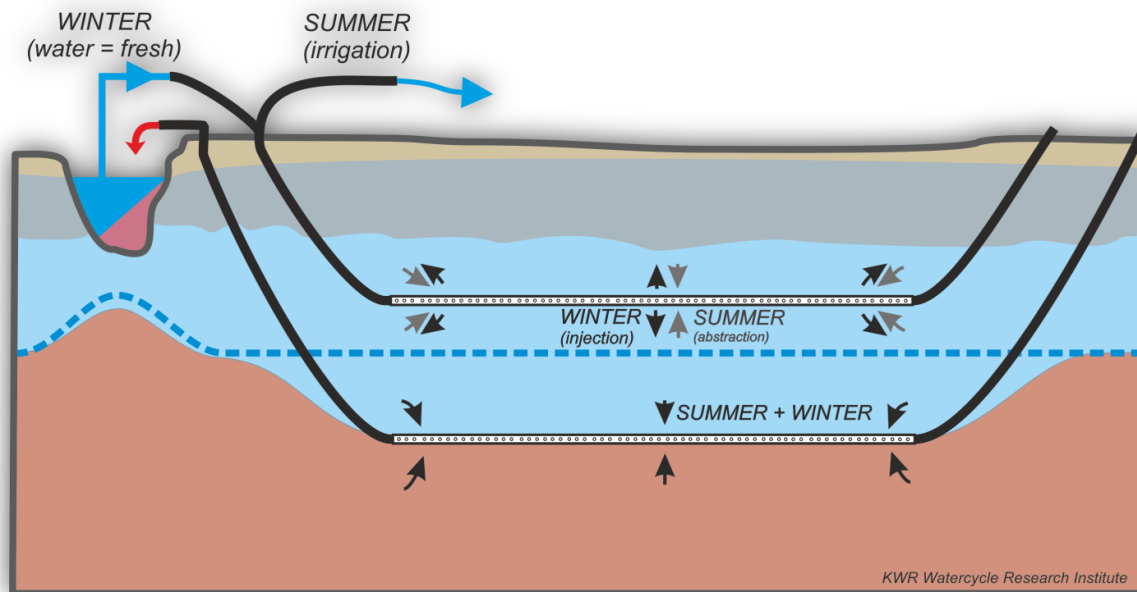

Figure 3-7: Schematic cross-section of a freshmaker set-up.

Horizontal wells are more efficient than vertical wells when it comes to small freshwater lenses (Essink, 2001) and when combined with a deeper well that manages the fresh-salt water interface, the total amount of freshwater abstracted (and injected) can be maximized (Figure 3-8). The freshwater lens during storage and abstraction is protected through continuous pumping of the salt water (Zuurbier et al., 2014a).

Using horizontal wells instead of vertical wells offer advantages such as longer filter lengths that allow higher infiltration volumes, the target aquifers can be considerably thinner than those of vertical wells and the surface space needed for such an installation is considerably reduced.

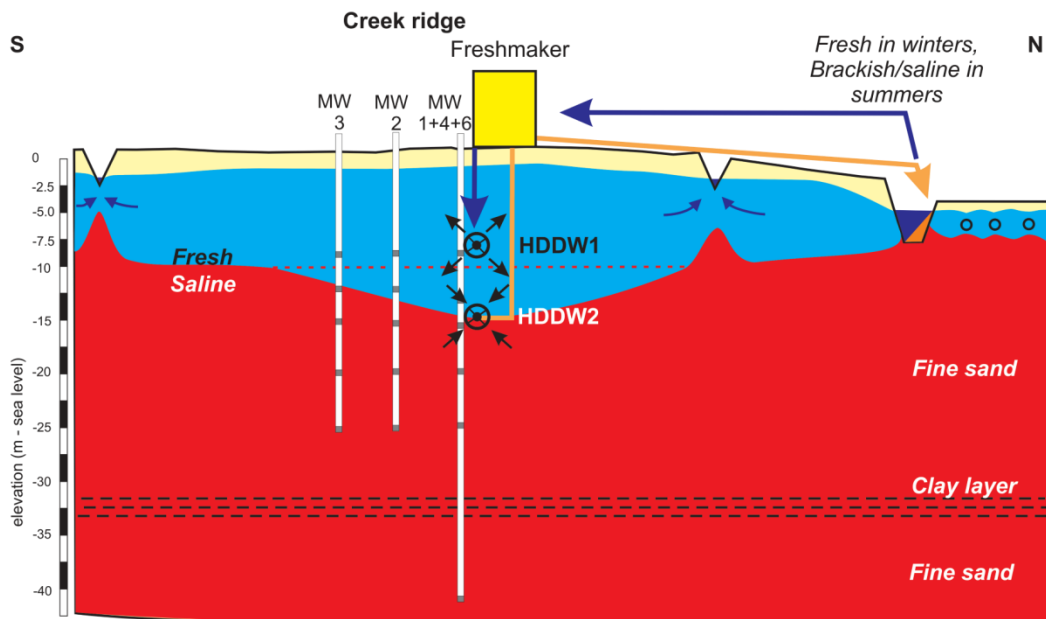

Figure 3-8: Cross section of the Freshmaker pilot set-up at Ovezande, in the South Western Delta of the Netherlands. The fresh water had a thickness of 9 meters with a 6m mixing zone and an underlying aquifer with a salinity of around 16800 mg Cl/l. MW = monitoring well, HDDW = horizontal directional drilled well. Taken from (Zuurbier et al., 2014a).

### 3.3.2.3 The freshkeeper

An alternative possibility of ASR in areas with brackish groundwater is the freshkeeper system, where the upconing of brackish water is intercepted by a deeper (or upgradient) well. This deeper well can be combined with a reverse osmosis installation (RO) with which the brackish water is turned into drinking, industrial or irrigation water and the concentrate that comes from the RO is injected in a deeper, more saline, confined aquifer (in the case of the Netherlands, (Stuyfzand and Raat, 2010) ). The limiting factor of this system is the disposal of the RO waste water that might contain antiscalants, constituents of the feed water and salinity levels might be higher than the ones present in the aquifer. The selection thus of the source brackish aquifer and the target aquifer of the disposal is key. The system should be anoxic and pressurized, with moderate chloride levels in the BWRO source water and low in minerals like  $\text{HCO}_3$ ,  $\text{SO}_4$ , Ca, Mg, Fe, Mn,  $\text{NH}_4$ ,  $\text{PO}_4$ ,  $\text{SiO}_2$  to reduce the clogging risk both in the RO membrane and in the well injection. The concentrate that results from the RO system should not exceed in salinity, nutrients and heavy metals the levels in the target aquifer. The permeate from the RO, on the other hand, should comply with the permitted concentrations for drinking water. This system provides on top of the efficient management of the fresh water lens by intercepting the salinized upconing, the advantages of a BWRO system: the good quality of brackish water as RO feed water when compared with the sea water and the possibility of applying RO far inland.

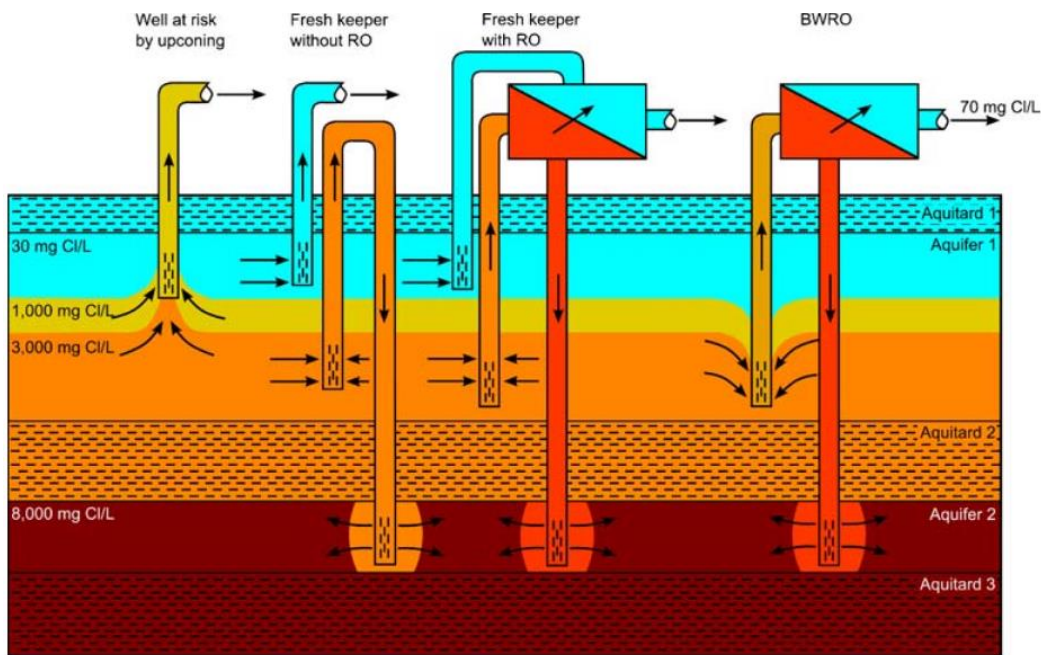

Figure 3-9: Schematic cross-section of a fresh water lens on top of a brackish aquifer\* and different types of groundwater abstraction, from left to right: fresh well salinizing by upconing, the fresh-keeper without reverse osmosis (RO), the freshkeeper with RO, and brackish water with RO (BWRO). \*The chloride stratification of the aquifer is indicated on the left of the cross-section and the chlorinity of the RO-concentrate is approximately 6,000 mg/l when the quantity of permeate equals the quantity of concentrate. Taken from (Stuyfzand and Raat, 2010)

### 3.3.3 Obstacles to the maintenance of well injection MAR systems

#### 3.3.3.1 Clogging of injection wells

One of the main differences between groundwater recharge by wells and via ponds is the entry velocity of the water. In the wells it is orders of magnitude higher than in infiltration ponds, which results in higher and quicker clogging risk. Some of the main clogging causes are the following (Olsthoorn, 1972):

1. suspended particles in the injection water;
2. formation of chemical precipitates in the injection water and the well;
3. formation of chemical precipitates in the soil;
4. gas bubbles in the water;
5. proliferation of bacteria in and around the well;
6. swelling and dispersion of clay;
7. erosion of soil structure and jamming of the aquifer.

From these, the first three are the principal causes of clogging that are encountered in MAR systems. The suspended particles in the injection water and in groundwater constitutes the so called mechanical clogging. The formation of chemical precipitates in the well and in the aquifer is what is called chemical clogging, originated mainly due to the mixture of oxic and anoxic waters. These two different types of clogging can be distinguished by measuring the difference in hydraulic head between the borehole wall and the aquifer and between the well head and the aquifer head. This difference in head is also called clogging resistance and it is measured as follows:

$$\text{Clogging resistance}_{\text{well}} = \frac{H_{\text{well}} - H_{\text{observation}}}{Q} * \frac{T + 20}{30}$$

Where  $H_{\text{well}}$  is the water level measured in the well,  $H_{\text{observation}}$  the water level in the piezometer,  $Q$  the flow rate and  $T$  the temperature (Olsthoorn, 1972). When multiple piezometers are located in the annulus close to the screen then it is possible to determine if clogging is occurring on the screen or on the borehole wall (Figure 3-10), this indicates if the clogging is chemical or mechanical, respectively.

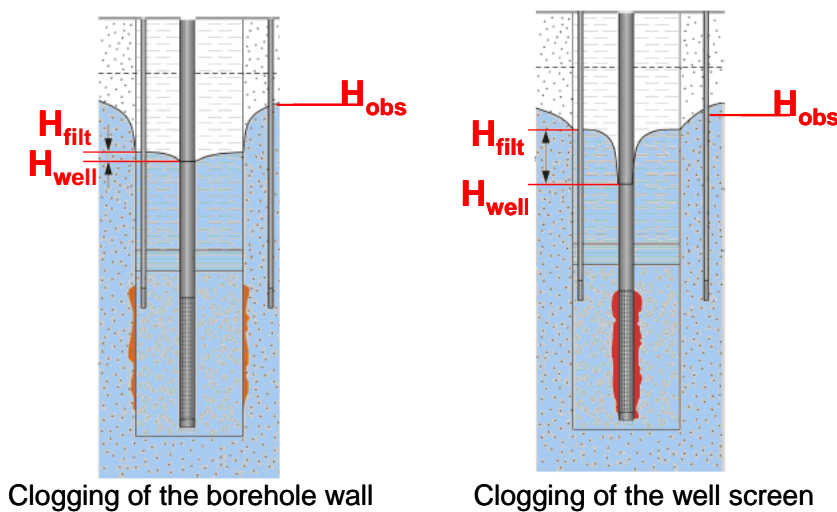

Figure 3-10: Location of observation points in an infiltration well and different types of clogging deduced from the measured water levels. Figure after Loma (2013)

The clogging potential of injected water is commonly measured through the membrane filtration index (MFI) and the assimilable organic carbon (AOC). Values under  $3s/L^2$  are advised for the MFI and under  $10 \mu\text{g acetate-C/L}$  for the AOC to avoid clogging (M. Hoogmoed, 2012).

Once the wells are clogged, there are different types of rehabilitation possible depending on the type of clogging. Rehabilitation is usually an alternative to the extra pretreatment that is necessary for deep injection, in contrast with open canal recharge systems. An overview of the rehabilitation methods most commonly used in the Netherlands is given in Table 3-6.

Table 3-6: Overview of the preferred rehabilitation methods in The Netherlands (after Bonte (2009))

Method	Description	Target
<b>mechanical</b>		
Brushing	Well screen is brushed and simultaneously the well is drained	Filter
HD-cleaning	Filter is cleaned with high pressure . Pressure 20-200 bar.	Filter, somewhat discharge.
Cleaning of the Pumps	Pumping out well with increased flow. Wells of the deep infiltration system of PWN and Waternet are frequently pumped clean.	Filter & gravel pack
Section cleaning or pumping Jutteren	Water is withdrawn from a section (1 - 2m) of the filter. The water is pushed down with pressure. When the pressure is released, the water level rises quickly. The pressure depends on depth filter and condition of the well.	Gravel pack
<b>chemical</b>		
	Chemical resources are always used in combination with a mechanical method	
Acids	Administating acid causes a lowering of the pH, with which precipitates can be dissolved. Using inorganic acid such as HCl is preferred over organic acids because of regrowth of bacteria.	Calcite, (iron) hydroxides
Oxidicers	Ensuring oxidation of organic matter in particular. Commonly used are hydrogen peroxide (H2O2) and sodium hypochlorite (CBL). The application of an acidic oxidant as HNO3, combines the advantages of an acid and an oxidizer.	Organic matter
Reducers	Reduction, for example of Fe (III) to Fe (II) dissolving the deposits. The use of an inorganic reducing agent is preferable. Often, a complexator is added (for example, Aixtractor) to ensure that Fe in complexed form remains in solution .	Hydroxides

### 3.3.3.2 Dutch experience with well clogging in well injection MAR systems

In 2009 a study was performed by Bonte (2009) where three long standing (up to 20 years) deep injection systems were analyzed in terms of their experiences with clogging. The characteristics of these systems and their clogging are summarized in Table 3-7. This study resulted in the following conclusions:

1. All of the clogging was composed by iron precipitates and iron reducing bacteria, that originated from:
  - Colloidal Fe and Mn present in the infiltrating water, that even in small concentrations, due to the big infiltrated volumes, can be relevant. Therefore the input of iron to the system should be carefully supervised.
  - Fe and Fe(OH)<sub>3</sub> derived from coagulation, which is either not completely filtered by the rapid sand filters or which is remobilized following back flushing of the filters
  - Fe and Mn present in ambient groundwater and transported to wells during the stand still of the systems.
  - Fe and Mn dissolved by reductive dissolution of iron and manganese hydroxides in the surroundings of the well during periods of stand still

2. The MFI and AOC proved to be useful indicators of clogging.
3. Deep well injection system can last an indefinite time with an appropriate optimization of the pre-treatment and periodic rehabilitation. The most successful rehabilitations were the ones using mechanical and chemical methods, performed before the clogging has become too severe. It is important therefore to do an accurate and continuous monitoring. From the chemical rehabilitations, the use of hydrogen peroxide with chlorine bleach turned out to be very successful.
4. Management of drilling fluids during well construction helps to prevent formation damage and clogging. Using help-casing, removing the drilling mud from the borehole wall with a reaming drilling head, and using degradable additives in the drilling mud are ways to manage formation damage during the drilling process to reduce the impact of future clogging.
5. Pre-treatments that remove organic micro-pollutants, such as active carbon, UV/ H<sub>2</sub>O<sub>2</sub> can mean a higher fraction of AOC in infiltration water, and a subsequent increased biological clogging. Certain treatment steps can lead to unwanted side effects negatively impacting on the overall efficiency.

Table 3-7: Comparison between the three deep infiltration systems

Drinking water company – location (type system)	Dunea- Walsdorp (ASTR)	PWN- Watervlak (ASTR)	Waternet – Leiduin deep infiltration pilot well field
General			
Production	5 Mm <sup>3</sup> /year	5 Mm <sup>3</sup> /year	0.7 Mm <sup>3</sup> /year
Residence time	100 to 200 days	1 to 12 months	No direct abstraction
Pre-treatment			
Source	Afgedamde Maas	Lekkanaal 50% Ijsselmeer 50%	Lekkanaal
Microsieves	Yes	Yes (Ijseelmeer)	No
Coagulation	Yes (FeCl)	Yes (FeCl)	Yes
Flotation	Yes	No	No
Rapid sand filter	Yes	Yes (upflow)	Yes

Drinking water company – location (type system)	Dunea- Walsdorp (ASTR)	PWN- Watervlak (ASTR)	Waternet – Leiduin deep infiltration pilot well field
Slow sand filter	No	no	Yes
Active carbon	Yes (since 1999)	Yes (since end 2008)	no
Target MFI injection water (s/l2)	3	5	unknown
Management			
Maintenance	none	Juttering with CBL and HCl Juttering with CBL Juttering with H2O2 & Cl	Rinse
Pressure monitoring	Manual measurements	Until 1998 weekly manual measurement then very occasional + continuous pressure measurement in the injection pipe	Pressure sensors
Infiltration wells			
Number	24	20	4
Diameter	1 m	1 m	unknown
Drilling technique	Not circulating drilling mud of drinking water & help-casing to aquifer	Conventional rinse of the well	Scraping of the drilling mud from the borehole after drilling with a special drilling head.
Filters	22 tot 38 m filter between NAP - 24 to -64	25 m between NAP - 50 to-90	NAP - 30 to -50



Drinking water company – location (type system)	Dunea- Walsdorp (ASTR)	PWN- Watervlak (ASTR)	Waternet – Leiduin deep infiltration pilot well field
Disposition	1 transect infiltration 2 parallel transects abstraction	Diamond pattern	1 transect infiltration 2 transects abstraction
Development	0,2 tot 0,3 m/h	0,4 m/h	0,2 m/h
Expected time until rehabilitation	5 to 7 years	15 to 20 years	
Clogging			
Clogging rate	Increasing trend Low values until 1995 with seasonal pattern High rates after stand still	Increasing trend Seasonal pattern Recent values missing	No increasing trend Seasonal pattern
Location clogging	Borehole wall mainly Filter screen ( less)	Filter screen	Sand filter Gravel pack (seasonal) Filter screen (little and constant)
MFI	<3S/L2 first years towards 5-6 s/L2	5-50 s/L2	Not measured
Nature clogging well filter	Fe, Mn, OM	Not analyzed	Fe-reducing bacteria
AOC	Increasing from 2001	around 25	Not measured

### 3.3.3.3 Calcite clogging - Regeneration with CO<sub>2</sub> dosage

During a fresh-keeper pilot (see section 3.3.3c), located in Zevenbergen in the South West of the Netherlands, clogging during injection of the concentrate was tackled through CO<sub>2</sub> dosage.

In a fresh-keeper system the water abstracted from a brackish aquifer goes to a reverse osmosis RO system where clean water is produced and the concentrate is injected in a deeper aquifer, whose quality will not be negatively affected by the injected concentrate. The concentrate in Zevenbergen is supersaturated with respect to calcite and other carbonates and these were precipitating severely in the soil. When the RO recovery increased from 50 to 65% the concentrate injection well became

completely clogged and even after regeneration with HCl and mechanical methods the capacity of the well decreased 32%. This proved that clogging by calcite was more difficult to treat than iron clogging (Raaf et al., 2013) and that it would be more efficient to prevent the precipitation than to treat it.

Calcite precipitation can be prevented by adding an acid to the concentrate, ideally a substance, such as HCl or CO<sub>2</sub>, that occurs naturally in the aquifers. Since Cl is one of the limiting factors as to the target aquifer for the concentrate (the concentrate should not be more saline than the receiving aquifer), adding HCl was ruled out as an option. Injecting CO<sub>2</sub> would also reduce the carbon foot-print of the system, and it is cheaper and safer to handle than HCl.

CO<sub>2</sub> dosage was performed with different settings of RO recovery (50% and 65%) proving to prevent in both cases calcite formation both in the well screen and in the aquifer (Raaf, 2013).

Calcite precipitation was observed as well in the RO membranes, since the CO<sub>2</sub> was dosed only before injection in the aquifer it is recommended, in order to prevent scaling of the RO membranes, to perform an acid cleaning of them on a yearly basis.

## References

- Aitchison-Earl, P., and Smith, M., 2008, Aquifer test guidelines.
- Appelo, C. A. J., and Postma, D., 2005, *Geochemistry, Groundwater and Pollution*, CRC Press, 649-649 p.:
- Beyer, W., 1964, On the determination of hydraulic conductivity of gravels and sands from grain-size distributions: *Wasser-wirtschaft-Wassertechnik*, v. 14, p. 165–169.
- Bonte, M., 2009, *Regeneratie en verstopping van infiltratieputten*: KWR, KWR 09.028.
- Bouwer, H., 1978, *Groundwater hydrology*, New York, McGraw-Hill.
- Bouwer, H., 1988, Design and management of infiltrations basins for artificial recharge of ground water, in *Proceedings of the 32nd annual New Mexiko conference on groundwater management*, Albuquerque, New Mexiko 1988, p. 111-123.
- Bouwer, H., 2002, Artificial recharge of groundwater: hydrogeology and engineering: *Hydrogeology Journal*, v. 10, no. 1, p. 121-142.
- Bouwer, H., Back, J. T., and Oliver, J. M., 1999, Predicting infiltration and ground water mounding for artificial recharge: *J Hydrol Eng*, v. 4, no. 4, p. 350-357.
- Bouwer, H., and Rice, R. C., 1984, Hydraulic properties of stony vadose zones: *Ground Water*, v. 22, no. 6, p. 696-705.
- Chapuis, R. P., 2004, Predicting the saturated hydraulic conductivity of sand and gravel using effective diameter and void ratio: *Can. Geotech.*, v. 42, p. 787-795.
- Dillon, P. J., 2002, *Management of Aquifer Recharge for Sustainability: Proceedings of the 4th International Symposium on Artificial Recharge of Groundwater, ISAR-4, Adelaide, South Australia, 22-26 September 2002*, AA Balkema.
- Driscoll, F. G., 1986, *Groundwater and wells*: St. Paul, Minnesota: Johnson Filtration Systems Inc., 1986, 2nd ed., v. 1.
- Essink, G. H. O., 2001, Improving fresh groundwater supply—problems and solutions: *Ocean & Coastal Management*, v. 44, no. 5, p. 429-449.
- Fetter, C. W., 2001, *Applied Hydrogeology*, New Jersey, Prentice-Hall.
- Freeze, R. A., and Cherry, J. A., 1979, *Groundwater*, Prentice Hall.
- Green, W. H., and Ampt, G., 1911, Studies of soil physics, part I – the flow of air and water through soils: *J.Ag.Sci.*, v. 4, no. 1, p. 1-24.

- Greskowiak, J., Prommer, H., Massmann, G., and Nuetzmann, G., 2006, Modeling Seasonal Redox Dynamics and the Corresponding Fate of the Pharmaceutical Residue Phenazone During Artificial Recharge of Groundwater: *Environmental Science & Technology*, v. 40, no. 21, p. 6615-6621.
- Halford, K. J., and Kuniandy, E. L., 2002, Documentation of spreadsheets for the analysis of aquifer-test and slug-test data: U.S Geological Survey.
- Hantush, M. S., 1967, Growth and decay of groundwater mounds in response to uniform percolation: *Water Resources Research*, v. 3, p. 227-234.
- Hazen, A., 1893, Some physical properties of sand and gravel with special reference to the use in filtration: 4th Annual Report, State Board of Health, Boston.
- Henzler, A. F., Greskowiak, J., and Massmann, G., 2014, Modeling the fate of organic micropollutants during river bank filtration (Berlin, Germany): *Journal of Contaminant Hydrology*, v. 156, no. 0, p. 78-92.
- Hölting, B., and Coldewey, W. G., 2009, *Hydrogeologie - Einführung in die Allgemeine und Angewandte Hydrogeologie*.
- Jaynes, D. B., 1990, Temperature variation effects on field-measured infiltration: *Soil Sci Soc Am J*, v. 54, no. 2, p. 305-311.
- Kaubisch, M., 1986, Zur indirekten Ermittlung hydrogeologischer Kennwerte von Kippenkomplexen, dargestellt am Beispiel des Braunkohlenbergbaus: *Bergakademie Freiberg*.
- Kaubisch, M., and Fischer, M., 1985, Zur Berechnung des Filtrationskoeffizienten in Tagebaukippen. Teil 3: Ermittlung des Filtrationskoeffizienten für schluffige Feinsande aus Mischbodenkippen durch Korngrößenanalysen: *Neue Bergbautechnik*, v. 15, p. 142-143.
- Kruseman, G. P., and de Ridder, N. A., 1994, Analysis and evaluation of pumping test data, International Institute for Land Reclamation and Improvement/ILRI.
- Kruseman, G. P., and Ridder, N. A., 1990, Analysis and evaluation of pumping test data: ILRI publication, no. 47.
- Lassabatere, L., Yilmaz, D., Peyrard, X., Peyneau, P. E., Lenoir, T., Šimůnek, J., and Angulo-Jaramillo, R., 2014, New Analytical Model for Cumulative Infiltration into Dual-Permeability Soils: *gsvadzone*, v. 13, no. 12, p. -.
- Loma, B. d. I., 2013, Clogging of deep well infiltration recharge systems in The Netherlands: KWR Watercycle Research Institute.
- M. Hoogmoed, P. H. D., S. Pool, 2012, *Regeneratie Diepinfiltratie Waalsdorp 2011*.

- Missimer, T. M., 2009, Water Supply Development, Aquifer Storage, and Concentrate Disposal for Membrane Water Treatment Facilities, Texas, Schlumberger, v. 1.
- Missimer, T. M., Guo, W., Walker, C. W., and Maliva, R. G., 2002, Hydraulic and density considerations in the design of aquifer storage and recovery systems: Florida Water Resources Journal, v. 55, no. 2, p. 30-36.
- Morell, I., Giménez, E., and Esteller, M. V., 1996, Application of principal components analysis to the study of salinization on the Castellon Plain (Spain): Science of The Total Environment, v. 177, no. 1-3, p. 161-171.
- Neumann, I., Barker, J., MacDonald, D., and Gale, I., 2004, Numerical approaches for approximating technical effectiveness of artificial recharge structures: British Geological Survey. Commissioned Report, CR/04/265N., p. 46-46.
- Olsthoorn, T. N., 1972, The clogging of recharge wells, main subjects: The Netherlands Waterworks' testing and research institute KIWA.
- Pyne, R. D. G., 2005, Aquifer storage recovery: a guide to groundwater recharge through wells, ASR systems.
- Raat, K. J., van Rosmalen, C., and Sjerps, R. M. A., 2013, Ervaringen met de regeneratie van een kalkverstopte injectieput (brakwater pilot Zevenbergen, Brabant Water): KWR, KWR 2013.040.
- Raat, S. v. d. W. K., 2013, Ervaringen met de dosering van CO<sub>2</sub> aan membraanconcentraat.
- Schaap, M. G., Leij, F. J., and van Genuchten, M. T., 2001, rosetta: a computer program for estimating soil hydraulic parameters with hierarchical pedotransfer functions: Journal of Hydrology, v. 251, no. 3-4, p. 163-176.
- Schulze-Makuch, D., Carlson, D. A., Cherkauer, D. S., and Malik, P., 1999, Scale Dependency of Hydraulic Conductivity in Heterogeneous Media: Ground Water, v. 37, no. 6, p. 904-919.
- Seelheim, F., 1880, Methoden zur Bestimmung der Durchlässigkeit des Bodens: Fresen. J. Anal. Chem, v. 19, p. 357-418.
- Stallman, R. W., 1971, Aquifer-test design, observation and data analysis, US Government Printing Office.
- Stuyfzand, P. J., 2011, Hydrogeochemical processes during riverbank filtration and artificial recharge of polluted surface waters: zonation, identification, and quantification, Riverbank Filtration for Water Security in Desert Countries, Springer, p. 97-128.
- Stuyfzand, P. J., and Raat, K. J., 2010, Benefits and hurdles of using brackish groundwater as a drinking water source in the Netherlands: Hydrogeology Journal, v. 18, no. 1, p. 117-130.

- Team, R. C., 2014, R: A Language and Environment for Statistical Computing: Vienna, Austria.
- USEPA, 1997, Field analytical and Site Characterization Technologies. Summary of Applications.
- USEPA, 2005, Groundwater Sampling and Monitoring with Direct Push Technologies: US Environmental Protection Agency,.
- van Houtte, E., and Verbauwheide, J., 2008, Operational experience with indirect potable reuse at the Flemish Coast: Desalination, v. 218, no. 1-3, p. 198-207.
- Vienken, T., and Dietrich, P., 2011, Field evaluation of methods for determining hydraulic conductivity from grain size data: Journal of Hydrology, v. 400, no. 1-2, p. 58-71.
- Vukovic, M., and Soro, A., 1992, Determination of Hydraulic Conductivity of Porous Media from Grain-Size Composition, first ed., Water Resources Publications: Littleton.
- Ward, J. D., Simmons, C. T., Dillon, P. J., and Pavelic, P., 2009, Integrated assessment of lateral flow, density effects and dispersion in aquifer storage and recovery: Journal of Hydrology, v. 370, no. 1, p. 83-99.
- WHR, 2008, Landwirtschaftliche Beregnung Grundwasseranreicherung. Hessenwasser GmbH & Co. KG: Wasserverband Hessisches Ried.
- Zuurbier, K., Zaadnoordijk, W. J., and Stuyfzand, P., 2014a, The Freshmaker - An innovative tool for freshwater storage and abstraction in salinized areas using sophisticated horizontal directional drilled wells (HDDWs): KWR, KWR 2014.056.
- Zuurbier, K. G., Bakker, M., Zaadnoordijk, W. J., and Stuyfzand, P. J., 2013, Identification of potential sites for aquifer storage and recovery (ASR) in coastal areas using ASR performance estimation methods: Hydrogeology Journal, v. 21, no. 6, p. 1373-1383.
- Zuurbier, K. G., Zaadnoordijk, W. J., and Stuyfzand, P. J., 2014b, How multiple partially penetrating wells improve the freshwater recovery of coastal aquifer storage and recovery (ASR) systems: A field and modeling study: Journal of Hydrology, v. 509, no. February, p. 430-441.

## 4 Mapping criteria for MAR pre-feasibility: application of the International Hydrogeological Map of Europe (IHME 1500)

Stephan Hannappel, Angelika Huber

HYDOR Consult GmbH, Am Borsigturm 40, 13507 Berlin, Germany

Quality assurance: C.Sprenger (Kompetenzzentrum Wasser Berlin)

### 4.1 Introduction

The International Hydrogeological Map of Europe at scale 1: 1,500,000 (IHME1500) consists of 25 map sheets providing a generalised overview of shallow aquifer properties in Europe (Struckmeyer & Margat 1995). The IHME1500 is a hydrogeological map series covering the European continent and parts of Turkey. The advantage of the IHME1500 is the European wide homogeneity of geological features and its digital availability. Each sheet consists of contributions by the respective countries represented in the map. Together with the explanatory notes, the map can be used for scientific purposes, for large-scale regional planning and as a framework for more detailed hydrogeological mapping (BGR & UNESCO 2014). To prove the thesis, if the IHME1500 is useful as a planning basis for pre-feasibility of new MAR sites, spatial information from the IHME1500 had been compared with information on local scale obtained from the European MAR catalogue (Hannappel et al. 2014). This catalogue contains general information and hydrogeological data to about 270 sites in a MS Access engine, which are derived from published documents. The aims of this study are:

- To what extend does the information from the IHME1500 match with information on local scale obtained from the European catalogue
- To what extend is the IHME1500 useful as a planning basis for pre-feasibility of new MAR sites

### 4.2 Methods and materials

The Federal Institute for Geosciences and Natural Resources (BGR) and the United Nations Educational, Scientific and Cultural Organization (UNESCO) are the project coordinators, supported by the International Association of Hydrogeologists (IAH) and the Commission for the Geological Map of the World (CGMW).

The map sheets are available as hardcopies or as scanned and georeferenced images in a GeoTIFF format entitled IHME1500 print (NIMA 1995). The IHME1500 v1.1 is a vector dataset resulting from the digitisation of the 25 map sheets of the International Hydrogeological Map of Europe at the of scale 1 : 1,500,000 (IHME1500). Data of the IHME1500 are available under [www.bgr.bund.de/ihme1500/](http://www.bgr.bund.de/ihme1500/). It consists of the following attributes of the IHME1500 (Duscher & Günther 2014):

- Aquifer types (areal feature): Distinction of six types of aquifers (see legend at Fig. 4.1) according to their generalized hydraulic productivity und rock types. Definition of these six types are given in Struckmeyer & Margat (1995)

- Lithology (areal feature): Lithological classification: it contains 1065 individual lithological descriptions, which are aggregated at five levels (e.g. the highest level is “consolidated material” and the detailed level is “Quartzites, sandstones, shales, volcanic rocks”)
- Seawater intrusion (areal feature): Areas with salinity ingress of groundwater caused by seawater intrusion
- Tectonic fractures (line feature with minor hydrogeological importance): Geological lineaments assigned to the five classes of known or supposed faults or overthrusts and boundaries of fractured belts in Iceland.

The IHME1500 v1.1 includes a correction of inconsistencies of the printed map sheets. Data were spatially adjusted to an up-to-date topographic base.

To prove the application of the map, data entries in the MAR Catalogue (<http://demeau-fp7.eu/D111>) were compared by their investigated geographic coordinates with the areal distribution of selected hydrogeological legend units in the map.

### 4.3 Results

Figure 4.1 shows the spatial distribution of all 278 MAR sites from the MAR Catalogue together with the regional distribution of the “aquifer type” from the IHME1500 with their six attributes (additionally “inland water” and “snow fields”).



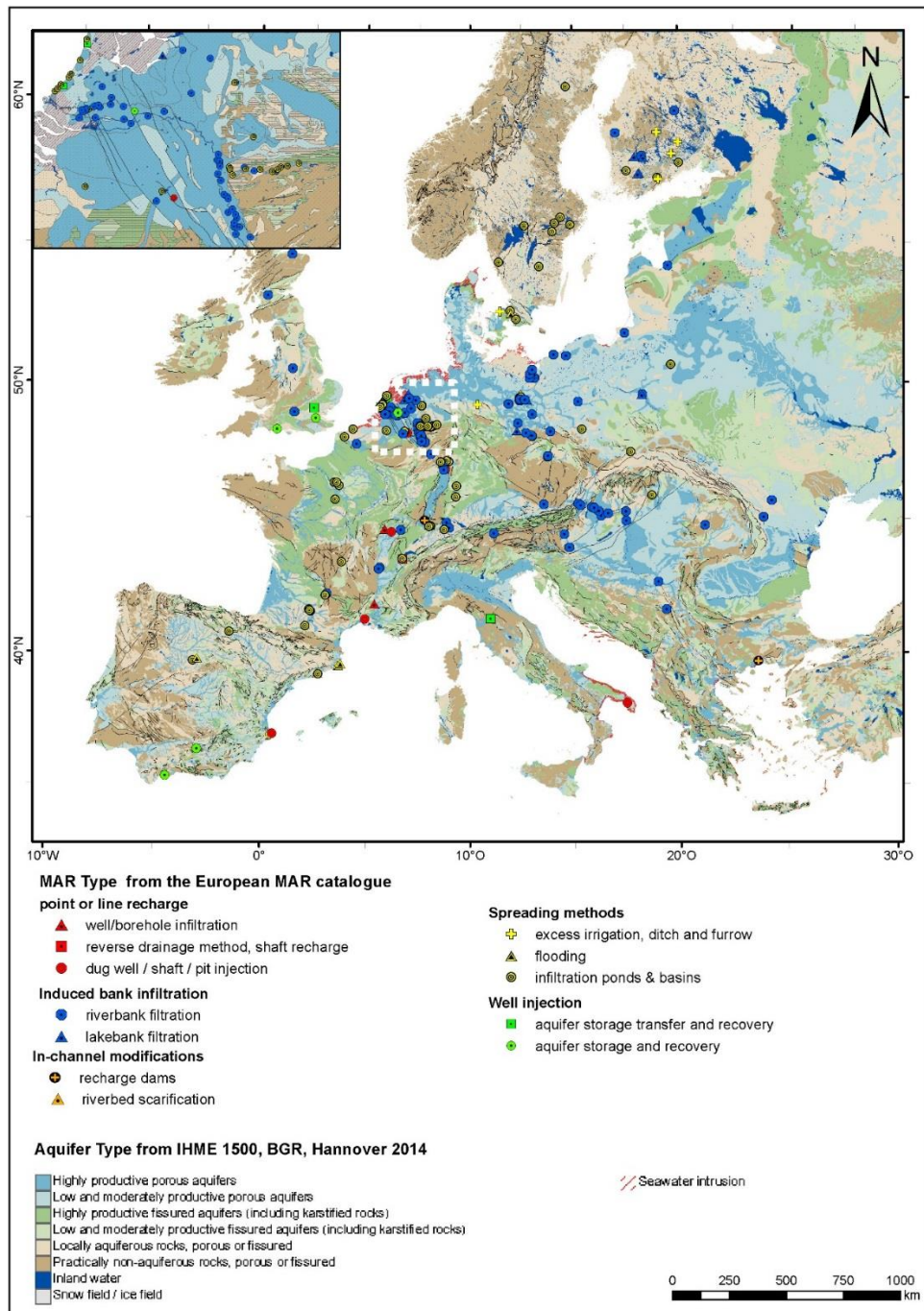

Figure 4-1: Spatial distribution of all 278 (active and inactive) MAR sites from the European MAR catalogue (modified from Hannappel et al. 2014) and “aquifer types” from the IHME1500 (BGR & UNESCO (eds.), 2014).

Information to the sites from the MAR Catalogue are given to the main MAR type, see headings in the legend of the map (e.g. “spreading methods”) and the specific MAR type (e.g. “flooding”). None of the MAR sites from the catalogue is situated in the “sea water intrusion” affected area indicated by the IHME 1500 (see Fig. 4.1).

For the comparison with the data of the sites in the MAR Catalogue, the two units of fissured and karstified rocks (green colors in Fig. 4.1) are unified to one unit. Figure 4.2 shows the distribution of MAR sites within the attributes of the “aquifer type” from the IHME 1500.

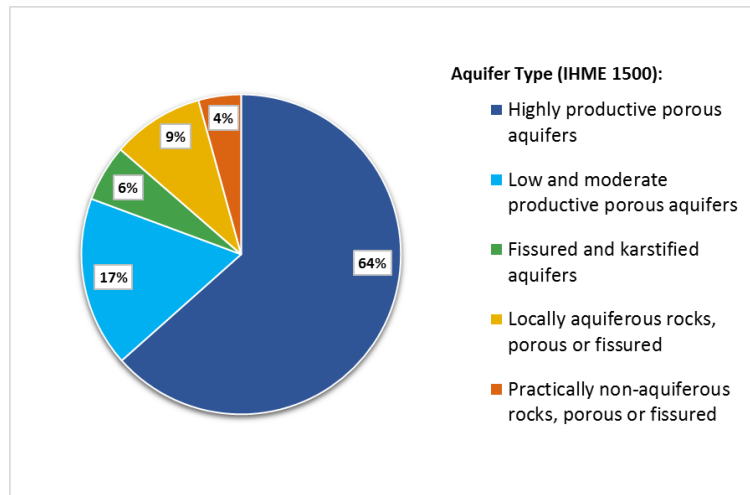

Figure 4-2: Distribution of MAR sites within the attribute class “Aquifer Type” of the IHME 1500.

Almost two third of the MAR sites (64 %) from the catalogue are found within the IHME 1500 aquifer type “highly productive porous aquifers”. These sites have in majority aquifer k-values  $> 1E-04$  m/s regarding to their hydraulic conductivities and aquifer thickness  $> 20$  or  $> 50$  Meter.

This demonstrates the importance of these aquifers for MAR and also the accordance of the IHME 1500 data. A few sites (4 %) are situated in the legend unit “practically non aquiferous rocks” (red color). For these sites the aquifer type is of minor or no importance for MAR sites (e.g. spreading methods) or they are lying in Scandinavia with a high potential need for MAR in regions with hard rock aquifers.

Figure 4.3 shows the number of MAR sites per nation within the attribute “aquifer type” of the IHME 1500.

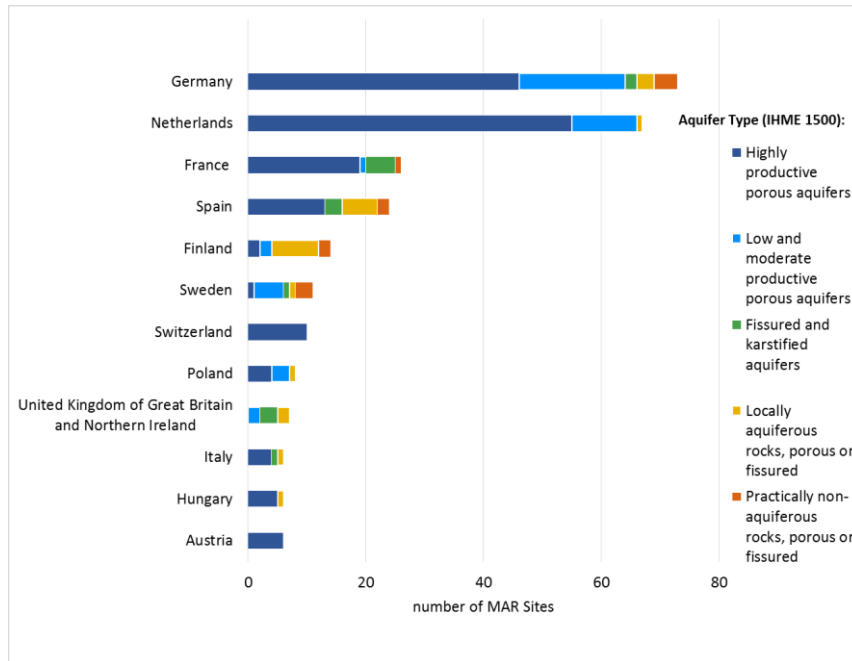

Figure 4-3: Distribution of MAR sites in different Aquifer Types of the IHME 1500 in selected countries.

In some countries (Germany, The Netherlands) this percentage is higher while in other countries (Finland, Sweden) porous aquifer have less percentage due to geological reasons.

Figure 4.4 shows the distribution of hydraulic conductivities from the European MAR catalogue (Hannappel et al. 2014) within the attribute “aquifer type” of the IHME 1500.

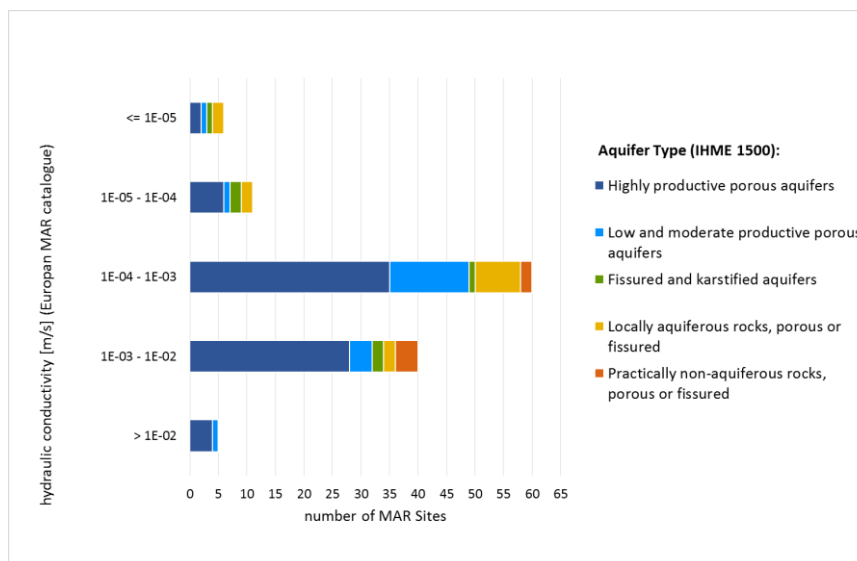

Figure 4-4: Comparison of hydraulic conductivity data from the MAR catalogue (Hannappel et al. 2014) with the attribute “aquifer type” from the IHME 1500 (BGR & UNESCO (eds.), 2014).

The aquifer type “highly productive porous aquifer” is found in all hydraulic conductivity classes, but dominates in coarse sediments with hydraulic conductivities  $> 1 \times 10^{-4}$  m/s. The number and the share of

locally aquiferous rocks increases in sediments with medium and low hydraulic conductivities ( $<1 \times 10^{-4}$  m/s). The two MAR sites from the catalogue with hydraulic conductivity  $< 1 \times 10^{-5}$  m/s but “highly productive porous aquifers” in the IHME 1500 map (see the dark blue bar on the top) as well as the few sites with medium or high k-values ( $> 10^{-4}$  and  $> 10^{-3}$  m/s) in the Catalogue which are situated in the legend units of the IHME 1500 “locally or none aquiferous rocks” (yellow and red bars at the bottom of the graph) are embedded in local aquifer structures, which could not be represented by the scale of the IHME 1500.

Figure 4.5 shows the percentage of the MAR sites within 17 aggregated lithological attributes in the IHME1500 in Europe.

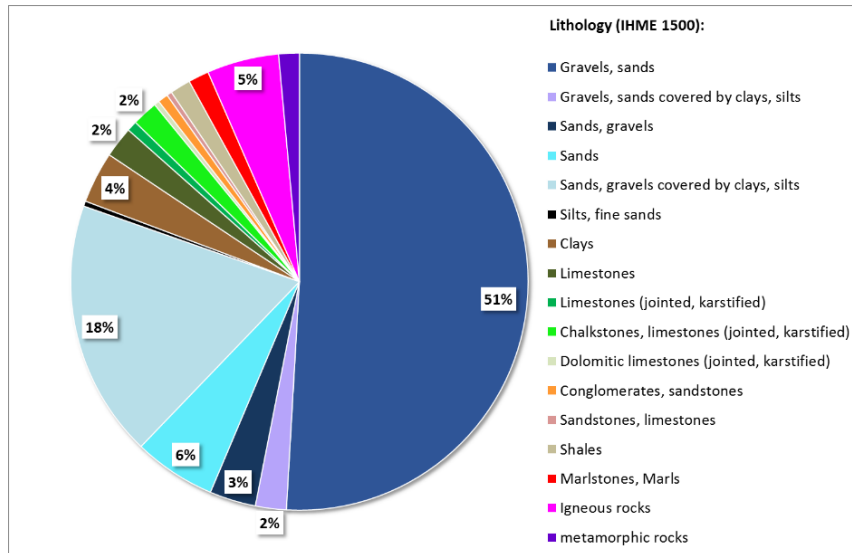

Figure 4-5: Distribution of MAR sites within the attribute class “lithological levels” of the IHME 1500.

The first name indicates the main component of the aquifer and the second name the minor component (e.g. “Gravel, sands” represents a coarser sediment than “Sands, gravel”). About 80 % of the sites from the MAR Catalogue are situated in gravel or sandy aquifers. This shows a very good accordance between the MAR catalogue and the IHME 1500. Figure 4.6 shows the distribution of the lithology units in selected countries.

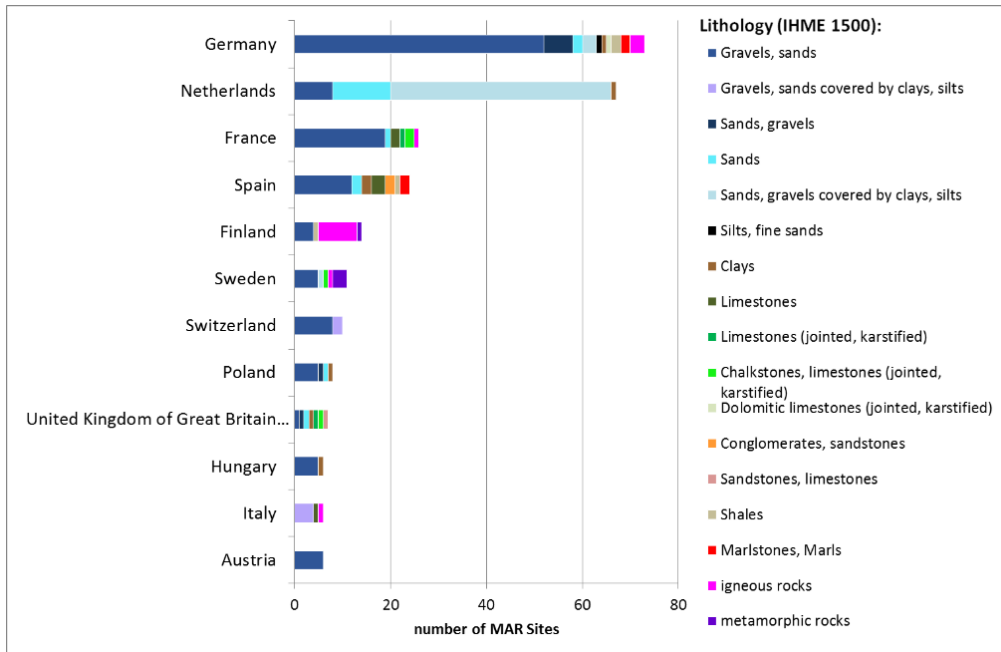

Figure 4-6: Distribution of MAR sites within the lithological levels of the IHME 1500 in selected countries.

Figure 4.7 shows the comparison between the IHME1500 and the MAR Catalogue regarding this attribute. Sandy and gravel units dominate the distribution of the 278 sites, also in whole Europe as in countries like Germany or France.

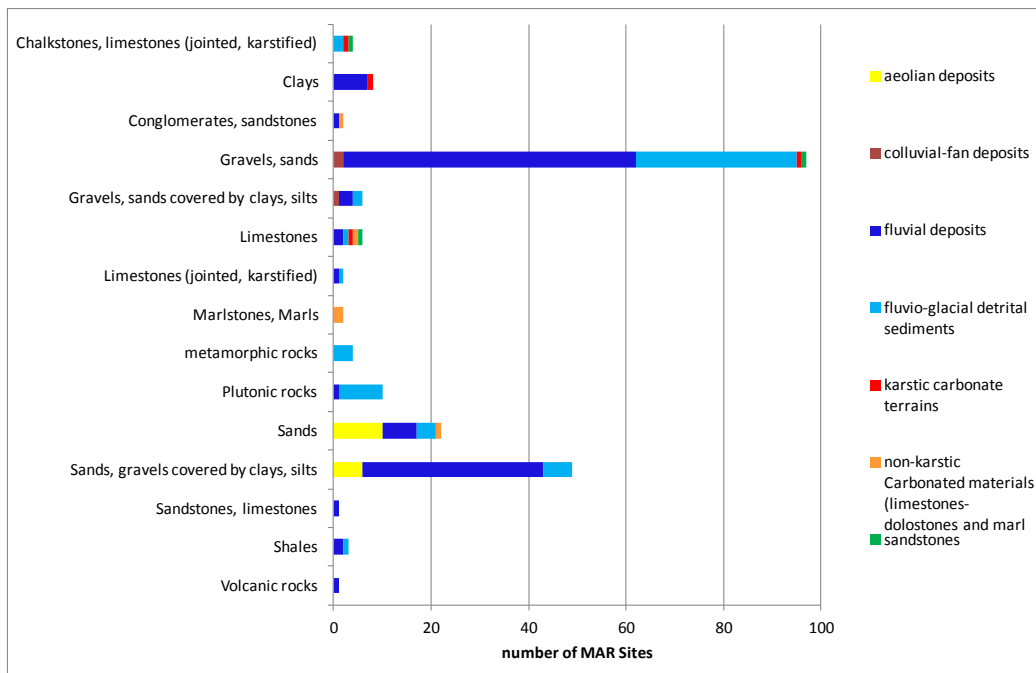

Figure 4-7: Comparison of aquifer type data from the MAR catalogue with lithological information from the IHME 1500.

The vast majority of the sites have corresponding entries (e.g. fluvial or fluvio-glacial sediments in the MAR Catalogue vs. gravels or sands in the IHME 1500). Only a few number of sites shows divergent results (e.g. fluvial deposits in volcanic rocks) due to the above mentioned reasons – the small scale of the IHME 1500 or a MAR type without hydrogeological reference to the aquifer type. However, fluvial deposits in the IHME 1500 unit “clays” shows the origin of the hydrogeological map, which is made by data of a geological surface map: “clay” is the coverage of the fluvial deposits at the surface, under which the MAR sites are situated within the aquifer.

#### 4.4 Conclusions

The comparison between the MAR catalogue and attributes from the IHME 1500 shows a conformity regarding hydrogeological features. The aquifer type “highly productive porous aquifer” from the IHME 1500 is likely to represent hydraulic conductivities  $> 1 \times 10^{-4}$  m/s.

However, the IHME 1500 can be applied for a pre-assessment of suitability for a planned MAR site, but detailed regional and local scale maps are necessary to effectively assess hydrogeological features.

## References

- BGR & UNESCO (eds.), 2014, International Hydrogeological Map of Europe 1:1,500,000 (IHME1500), Digital map data v1.1, Hannover/Paris.
- Hannappel, S., Scheibler, F., Huber, A., Sprenger, C. (2014): M11.1 - Characterization of European managed aquifer recharge (MAR) sites – Analysis, accessed: May 2015, <http://demeau-fp7.eu/results/mar>
- NIMA National Imagery and Mapping Agency (1995): Performance Specification Vector Smart Map (VMap) Level 0. - MIL-PRF-89039, Int. Amendment 1.
- Struckmeier, W. F., Margat, J. (1995): Hydrogeological maps, A Guide and a Standard Legend.- International Association of Hydrogeologists, Volume 17, Heise.

## 5 Pre-treatment options during MAR

Ragini Hüschi, Linda Stamm, Julia Plattner

University of Applied Sciences and Arts Northwestern Switzerland School of Life Sciences Institute for Ecopreneurship, Mattenstrasse 22, 4059 Basel, Switzerland

Quality assurance: C.Sprenger (Kompetenzzentrum Wasser Berlin)

### 5.1 Introduction

Successful MAR schemes in Europe have been using storm water, drinking water, surface water, mains water, rain water, groundwater from other aquifers, desalinated seawater and treated waste water. Depending on the prevalent conditions, the need and use of pre-treatment may vary considerably. They are mainly determined by the following parameters (Sharma et al., 2015a; Dillon et al., 2009b; Dillon et al., 2008; Asano & Cotruvo, 2004):

- Source water quality used for recharge
- Intended end-use of the extracted water
- Local water quality guidelines
- Local hydrological conditions
- Process conditions in the aquifer (e.g. aquifer mineralogy, grain size, hydraulic conductivity, degree of macro-porosity/fracturing and confinement)
- Ambient groundwater quality
- MAR system (surface infiltration (basins), vadose zone wells or direct injection wells)
- Public acceptance

Pre-treatment is applied in MAR systems primarily for the following reasons (Sharma, 2015b; Dillon et al., 2008; Asano & Cotruvo, 2004):

- Removal of critical contaminants from the source water, which cannot or not fully be removed by the MAR system (e.g. bulk organics, nutrients and organic micro pollutants)
- Removal of critical contaminants in order to enhance system performance and removal efficiencies (e.g. total suspended solids (TSS) may cause clogging, nutrients may cause biological change in the redox chemistry)
- Removal of critical contaminants in order to ensure long-term functioning (e.g. clogging)
- Meeting local water quality requirements for artificial recharge and use of reclaimed water (e.g. safe drinking water, no contamination of the aquifer)



- Meeting water quality requirements under future changing conditions and therefore deteriorating source water quality (e.g. climate change, population increase, change in land use, emerging contaminants)
- Ensuring existing beneficial uses of the aquifer beyond the attenuation zone (e.g. the area surrounding the zone of recharge, where natural attenuation of contaminants such as chemicals and microorganisms takes place)
- Ensuring safe future beneficial uses within the attenuation zone on cessation of aquifer use for water treatment

The MAR system components shown in Figure 5-1 can be combined in various ways depending on source water quality and treatment requirements.

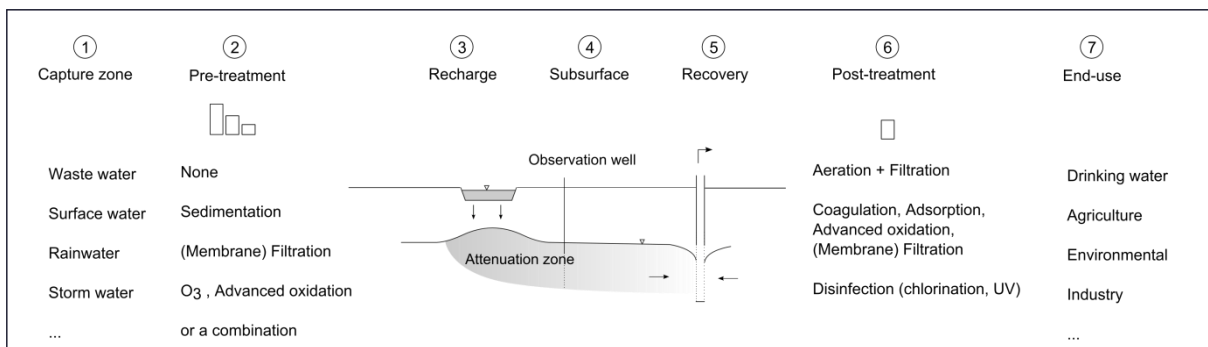

**Figure 5-1: Main components of MAR system with pre- and post-treatment options.**

Lower quality source water generally has to be treated to a higher degree in cases of (i) high quality aquifer water, (ii) end uses with high quality requirements (e.g. drinking water) and (iii) the use of fine-grained aquifers in order to avoid clogging of recharge basins, galleries or wells (Dillon et al., 2009a). Figure 5-2 shows possible pre- and post-treatment processes dependent on water source and end-use. Choice of the right pre-treatment allows recovery of recharged groundwater from any water source and for any end use.

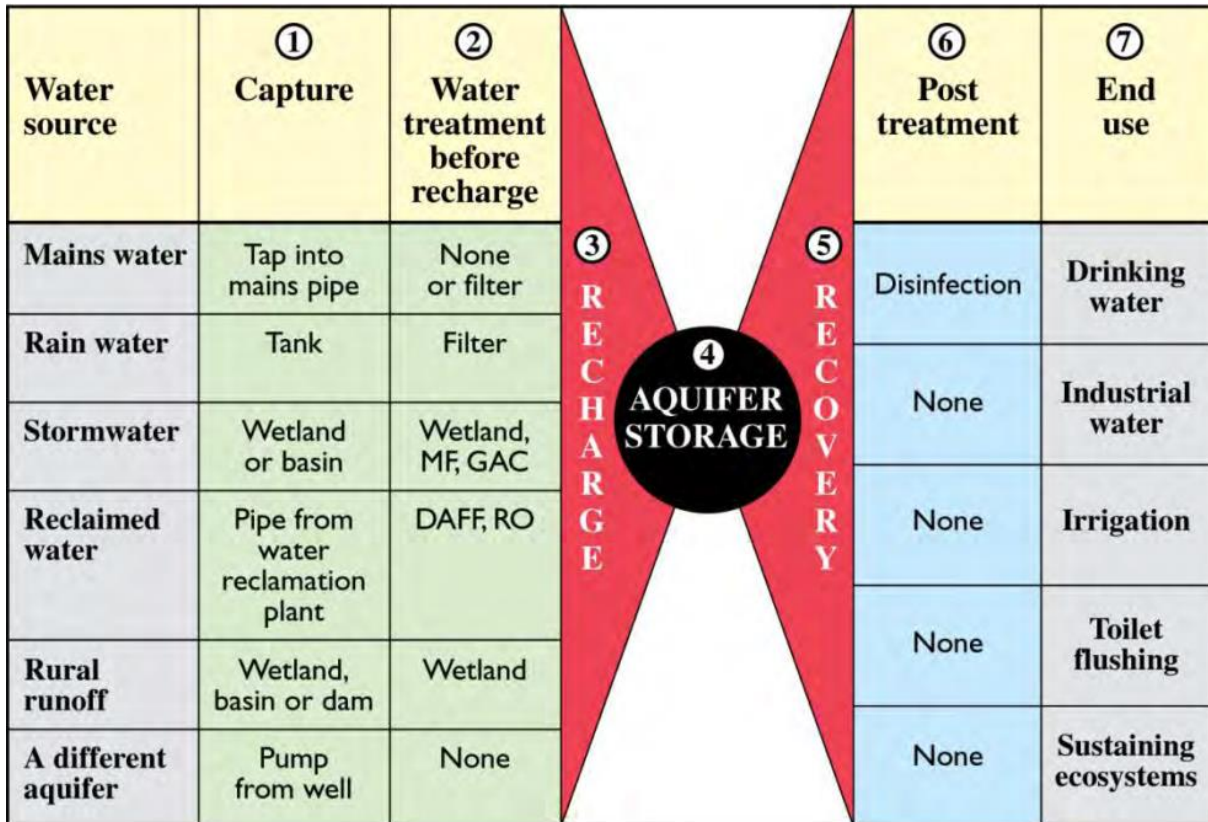

Figure 5-2: Typical water sources, capture and pre-treatment methods for MAR (Dillon et al., 2009a). MF: Microfiltration, GAC: Granular Activated Carbon, DAFF: Dissolved Air Flotation and Filtration, RO: Reverse Osmosis.

Dependent on the system determining parameters, MAR systems can have pre-treatment, post-treatment or both (Sharma et al., 2015b). Where river or lake water of low turbidity is diverted to infiltration basins to augment groundwater supplies, no treatment may be necessary (Dillon et al., 2009a). When reclaimed water or other polluted water sources for use as potable water are recharged, adequate treatment is imperative to avoid health risks to consumers. Of main concern are (i) microbiological quality, (ii) total mineral content (total dissolved solids), (iii) presence of heavy metal toxicants and (iv) concentrations of stable and possibly harmful organic substances. Primary treatment of waste water and dissolved air flotation can be sufficient for a SAT system whereas direct injection into the aquifer will require advanced upstream sewage treatment (Asano & Cotruvo, 2004).

Common pre-treatment methods for MAR systems are sedimentation, filtration and disinfection. Primary sedimentation and sand filtration are basic and low cost measures that are used for TSS and turbidity reduction. High TSS concentrations are critical, because they exert strain on the distribution system, cause clogging, reduce the flow length and travel times in the groundwater and reduce treatment efficiencies (e.g. of nitrogen removal). TSS can also act as carriers for heavy metals. Reverse osmosis (RO), ion exchange and biological denitrification are used to reduce nitrogen concentrations from high fertilizer use and insufficient sewage treatment, activated carbon, oxidation-filtration or membrane processes for the reduction of emerging pollutants (Sharma, 2015b).

Some pre-treatment filters incorporate additional layers of adsorbents for the removal of heavy metals or other specific contaminants from source water before recharge. Further pre-treatment processes include pre-screening, skimming, decantation, coagulation and flocculation, dissolved air flotation, microsieving, activated sludge, biofilters and wetlands (Table 5-1) (Van der Hoek et al., 2000; Balke & Zhu, 2008; Dillon et al., 2009b). Investigation of ASR in a fine grained aquifer showed that pre-treatment of the recharge water with microfiltration (MF) and granular activated carbon (GAC) in order to prevent clogging of the well was a more stringent condition than meeting groundwater and end water quality requirements (Dillon et al., 2009a).

## 5.2 Brief description of main treatment steps

Engineered treatment processes are designed for specific flow conditions, water quality (i.e. concentrations of specific species and constituents) and flow rate. Highly variable water quality can lead to difficulties in process operation. Therefore, several pre-treatment steps can be necessary to reach a more or less uniform water quality for the next treatment step to work efficiently (Dillon et al., 2008). A roughing filter, for example, is often used to provide sufficient water quality for biofiltration to work economically (Page et al., 2006). In conventional waste water treatment physical, chemical and biological processes are combined to remove solids, organic matter, nutrients and other constituents. Treatment of municipal waste water is often followed by a disinfection step to guarantee pathogen inactivation (Al-Rekabi et al., 2007). The treatment steps used in (waste-)water treatment are shortly described in chapters 5.2.1 to 5.2.5.

An overview of pre-treatment steps for MAR systems is given in Table 5-1. Listed are pre-treatment steps used in MAR systems in Europe (as described in chapter 5.5 and 5.6) supplemented by methods described in literature (Dillon et al., 2008).

**Table 5-1: Overview of pre-treatment steps for MAR systems.**

Treatment type	Objective	Treatment steps
Mechanical	Particle removal	Screening Sand and oil trap Roughing filter Rapid sand filtration Lamellar decantation Clarification pond Surface filtration Sedimentation
Physio-chemical	Removal of dissolved compounds	Activated carbon filtration Coagulation/flocculation Dissolved air flotation

Treatment type	Objective	Treatment steps
		Membrane filtration Cartridge filtration Microsieving Ion exchange
Chemical	Removal of organics and inorganics  Avoidance of metal leaching	Chemical P removal Oxidation/reduction Fe/Mn removal by oxidation pH adjustment Dissolved oxygen (DO) removal
Biological	Degradation of organic compounds Removal of inorganic compounds (N, P)	Activated sludge digestion Nitrification/denitrification Biological P removal Biofiltration Membrane bioreactor Settling and aeration ponds Wetland ponds Reedbeds
Disinfection	Removal, deactivation or killing of pathogenic microorganisms	UV disinfection Chemical disinfection

### 5.2.1 Preliminary treatment

In preliminary treatment, coarse solids and other bulk material is removed by processes like coarse screening, grit removal and comminution. To avoid settling of organic solids flow rates are kept sufficiently high (FAO, 2014; Al-Rekabi et al., 2007).

### 5.2.2 Primary treatment

In primary treatment, settleable organic and inorganic solids are removed by sedimentation and floating scum by skimming. The effluent from primary treatment is called primary effluent and is reduced by 25 to 50% in biological oxygen demand (BOD<sub>5</sub>), by 50 to 70% in suspended solids (SS) and by about 65% in oil and grease content compared to raw waste water. Parts of organic nitrogen, organic phosphorus, and heavy metals associated with solids are also removed. On colloidal and dissolved constituents in waste water primary treatment has no effect. Settled solids and scum make up the primary sludge and are led to further processing, usually in anaerobic digesters (FAO, 2014; Al-Rekabi et al., 2007).

### 5.2.3 Secondary treatment

In secondary treatment, residual organics and suspended solids are removed from the primary effluent. Often, this is done by aerobic biological treatment in activated sludge systems, i.e. treatment involving

microorganisms, which are metabolizing the biodegradable dissolved and colloidal organic matter in the presence of oxygen. Products of activated sludge treatment are increased microbial biomass and inorganic end-products (mainly CO<sub>2</sub>, NH<sub>3</sub>, and H<sub>2</sub>O). The excess biomass is removed by sedimentation from the secondary effluent in clarifiers and further processed as secondary or biological sludge, often together with the primary sludge (FAO, 2014; Al-Rekabi et al., 2007). Other methods using microbial degradation include trickling filters or biofilters, rotating biological contactors (RBC), oxidation ditches, treatment ponds and lagoons (FAO, 2014; Drinan & Spellman, 2013) and, mainly for industrial waste water or in hot climates for municipal waste water, anaerobic digestion (Haandel & Lettinga, 1994). Primary and secondary treatment reduces the largest part of the BOD and suspended solids as well as part of the heavy metals (FAO, 2014; Al-Rekabi et al., 2007).

#### **5.2.4 Tertiary treatment**

Tertiary treatment is part of advanced waste water treatment (see 5.2.5). Advanced waste water treatment is called tertiary treatment, if it follows conventional secondary treatment. Tertiary treatment often includes filtration for removal of remaining suspended solids or multi-step processes for organics, suspended solids, nutrient removal and disinfection (Al-Rekabi et al., 2007; Tchobanoglous et al., 2002).

#### **5.2.5 Advanced treatment**

In advanced waste water treatment, constituents that cannot be removed by primary and secondary treatment like nitrogen and phosphorus, additional suspended solids, refractory organics, pathogens, volatile organic compounds (VOC), odors, heavy metals and dissolved solids are removed in specialized treatment steps. Nutrient removal is often included in an adapted activated sludge system. There, nitrogen is transformed in a 2-step-process to nitrite and nitrate. In a supplementary anaerobic process step, nitrate is converted to gaseous nitrogen. Phosphate elimination can be achieved biologically or by chemically induced precipitation. Advanced treatment can be applied complementary to primary and/or secondary treatment or replace secondary treatment (FAO, 2014; Al-Rekabi et al., 2007; Tchobanoglous et al., 2002). Although often primary and secondary treatment provide an adequate water quality, advanced treatment might be required for direct or indirect water reuse, to alleviate pollution loads on receiving waters or for industrial purposes (FAO, 2014; Al-Rekabi et al., 2007). The increasing awareness of the effects of micropollutants in municipal and industrial waste water effluents on aquatic life has recently led to increasing demand for advanced treatment technologies included in conventional WWTPs (FOEN, 2012).

Advanced treatment processes contain methods like coagulation/flocculation, chemical precipitation, depth or surface filtration, biofilters, microstraining, chemical or advanced oxidation, sequenced anaerobic/aerobic bio-processes, chemical treatment, chemical scrubbers, (carbon) adsorption, membrane processes, ion exchange, air stripping and disinfection by chlorine compounds, chlorine dioxide, ozonation or UV radiation (Al-Rekabi et al., 2007; Tchobanoglous et al., 2002).

### **5.3 Source water types and main water quality concerns for MAR**

Source water quality is one factor, which needs to be considered when choosing an appropriate pre-treatment for MAR systems.

Table 5-2 summarizes the main water quality concerns for different types of source water, which will be described in more detail in this chapter.

**Table 5-2: Main water quality concerns by water source**

<b>Water Source</b>	<b>Main water quality concern</b>
River and lake water	TSS, DOM, turbidity, nutrients, pathogens, cyanotoxins, heavy metals, micropollutants (i.e. pesticides, EDC, PhAC, PCP), hydrocarbons
Storm water	TSS, nutrients, VSS, COD, heavy metals
Treated waste water	Nutrients, pathogens, mineral content, metals, pesticides, EDC, PhAC, PCP, BOD <sub>5</sub> , COD, DO, AOX, TSS, active chlorine, chloride, sulphate, fluor, surfactants, mineral oil, chloride solvents, disinfection by-products, complex-forming substances
Urban run-off	Rubber fragments, heavy metals, sodium and sulphate, pesticides, hydrocarbons, solvents
Agricultural run-off	Nutrients, pesticides, fecal microbes and sediments

In Table 5-3 pre-treatment methods applied in MAR systems using reclaimed water and storm water are shown together with their effectiveness on TSS and organics removal.

**Table 5-3: Pre-treatments for MAR using reclaimed water and storm water and relative effectiveness of each treatment for removal of TSS and liable organics (Dillon et al., 2008)**

<b>Pre-treatment</b>	<b>Reclaimed Water</b>	<b>Storm water</b>	<b>SS removal</b>	<b>Organics removal</b>
<b>Roughing filter</b>		Y	*	
<b>Rapid sand filtration</b>		Y	*	
<b>Biofiltration</b>		Y	***	**
<b>Activated carbon filtration</b>	Y	Y	*	***
<b>Chemical coagulation and</b>		Y	**	*

Pre-treatment	Reclaimed Water	Storm water	SS removal	Organics removal
<b>filtration</b>				
<b>Dissolved air flotation and filtration</b>	Y		***	*
<b>Membrane bioreactor</b>	Y		***	*
<b>MF</b>		Y	***	
<b>RO</b>		Y	***	***
<b>Activated sludge digestion</b>	Y		*	**
<b>Settling/aeration ponds</b>	Y	Y	*	*
<b>Wetland ponds</b>		Y	**	*
<b>Reedbeds</b>		Y	**	*

Y = treatment has been widely applied for this type of source water

Treatment effectiveness:      blank = ineffective  
    \* = only partially effective  
    \*\* = moderately effective  
    \*\*\* = very effective

### 5.3.1 Surface water

Surface water is mainly rain water that collects in natural water bodies (i.e. river and lake water) or groundwater that emerges from springs (US EPA, 2011). It is the most common source for MAR systems (Hannappel et al., 2014). Surface water quality can vary considerably depending on geology, soil properties, vegetation, climate, land use, human activity and other factors. The terrain the water is flowing through influences mineral composition, silt content and content of suspended particles. Temperature, content of organic matter and the degree of turbulence determine the oxygen content. Different life forms within and besides water bodies affect the content of organic matter (GE Power & Water, 2012). Natural organic matter (NOM) as such is not toxic to humans, but is a precursor to disinfection by-products (Maeng et al., 2011; Luet al., 2009). Typical impurities are turbidity, hardness, free mineral acid, carbon dioxide, sulfate, chloride, fluoride, sodium, silica, iron, manganese, aluminum, hydrogen sulfide and ammonia (GE Power & Water, 2012). In agricultural areas run-off water often carries nutrients like nitrate and phosphate, pesticides, fecal microbes and sediments into the water bodies. Surface run-off in urban areas

can contain rubber fragments, heavy metals, sodium and sulfate, pesticides, hydrocarbons and solvents (Tong & Chen, 2002; EEA, n.d.).

Physical and chemical characteristics of surface water can vary strongly both short-term, seasonally and long-term due to extreme weather events, seasonal variations and circumstances (GE Power & Water, 2012).

The analytical results of a three-year monitoring program of major river systems, streams tributaries and ditches in Northern Greece (Simeonov et al., 2003) give an overview of concentrations and values of field pH, electrical conductivity (EC), dissolved oxygen (DO), total suspended solids (TSS), chemical oxygen demand (COD), biological oxygen demand (BOD<sub>5</sub>), organic (Kjeldahl) nitrogen (TON), acid-hydrolysable (total) phosphorus (TP), orthophosphate (PO<sub>4</sub><sup>3-</sup>), nitrite (NO<sup>2-</sup>), nitrate (NO<sup>3-</sup>), ammonium (NH<sup>4+</sup>) and the acid-available fractions of metals and other toxic elements that can be expected in surface waters. They are listed and compared to the standards defined in the EU drinking water directive in Table 5-4. The EU groundwater directive defines standards for nitrates (50 mg/l) and active substances in pesticides, including relevant metabolites and reaction products (0.1 µg/l for each individual substance and 0.5 µg/l in total). Threshold values for other pollutants are established country-specifically (Council Directive 2006/118/EC).

**Table 5-4 Analytical results of a three-year monitoring program of the major river systems, streams tributaries and ditches in Northern Greece (Simeonov et al., 2003; Council Directive 98/83/EC)**

Component	Unit	Mean + Std. Dev.	Minimum	Maximum	EU Drinking water standard
pH	---	8.1 ± 0.26	7.7	8.6	≥ 6.5 and ≤ 9.5
EC	µS cm <sup>-1</sup>	421 ± 193	126	690	2500 (at 20°C)
DO	mg L <sup>-1</sup>	7.4 ± 1.2	3.7	12.3	---
TSS	mg L <sup>-1</sup>	17.7 ± 14.4	6.2	45.8	---
COD	mg L <sup>-1</sup>	12.2 ± 11.6	4.0	94.0	---
BOD <sub>5</sub>	mg L <sup>-1</sup>	11.4 ± 9.3	2.0	8.0	---
TON	mg L <sup>-1</sup>	0.62 ± 0.71	0.02	2.55	---
TP	mg L <sup>-1</sup>	0.57 ± 0.63	0.14	1.97	---
PO43-	mg L <sup>-1</sup>	0.22 ± 0.26	0.06	0.53	---
NO2-	mg L <sup>-1</sup>	0.21 ± 0.27	0.01	1.56	0.50
NO3-	mg L <sup>-1</sup>	0.38 ± 0.34	0.3	10.2	50



Component	Unit	Mean + Std. Dev.	Minimum	Maximum	EU Drinking water standard
NH4+	mg L <sup>-1</sup>	1.22 ± 1.06	0.03	3.08	0.5
Ag	µg L <sup>-1</sup>	1.1 ± 0.02	1.0	3.0	---
As	µg L <sup>-1</sup>	Less than 0.1	Less than 0.1	Less than 0.1	10
Cd	µg L <sup>-1</sup>	0.26 ± 0.19	0.1	0.6	5.0
Cr	µg L <sup>-1</sup>	6.5 ± 5.5	1.0	18.0	50
Cu	µg L <sup>-1</sup>	4.2 ± 2.4	2.0	7.0	2000
Fe	µg L <sup>-1</sup>	326.6 ± 211.9	113	833	200
Hg	µg L <sup>-1</sup>	Less than 0.2	Less than 0.2	Less than 0.2	1.0
Mn	µg L <sup>-1</sup>	155.4 ± 102.3	45	291	50
Ni	µg L <sup>-1</sup>	4.1 ± 2.9	2.0	12.0	20
Se	µg L <sup>-1</sup>	Less than 0.1	Less than 0.1	Less than 0.1	10
Zn	µg L <sup>-1</sup>	57.2 ± 44.8	20	157	---

In addition to the factors described above (5.3.1), industrial or domestic discharges and the remobilization of contaminants in sediments or soil can have a strong effect on the water quality of rivers and lakes. Along the flow of a river (from spring to mouth), the water quality can decrease significantly (US EPA, 2011). Typical contaminants found in surface water bodies are suspended solids, dissolved organic matter (DOM), nutrients, pathogens, mainly from waste water effluents, cyanotoxins, heavy metals and micropollutants such as pesticides, pharmaceuticals, hydrocarbons and endocrine disrupting compounds (EDC) (Sprenger et al., 2011; Turgut, 2003).

Industrial waste water is an important source of water pollution. Depending on the industry, waste water contaminants differ. Table 5-5 lists typical contaminants produced by different industries.

Table 5-5: Water pollutants by industrial sector (Hanchang, n.d.)

Industrial Sector	Pollutant
Iron and steel	BOD, COD, oil, metals, acids, phenols, cyanide
Metal working industry	Metals (Cr, Ni, Zn, Cd, Pb, Fe, Ti)
Textiles and leather	BOD, solids, sulfates, chromium

Industrial Sector	Pollutant
Pulp and paper	BOD, COD, solids, chlorinated organic compounds, dioxin
Petrochemicals and refineries	BOD, COD, mineral oils, phenols, chromium
Chemicals	COD, organic chemicals, heavy metals, SS, cyanide
Non-ferrous metals	Fluorine, SS
Microelectronics	COD, organic chemicals
Mining	SS, metals, acids, salts
Photo processing	Silver
Dry cleaning	Solvents
Car repair	Solvents
Printing plants	Inks, dyes

Contaminants from municipal waste water plants that can impact river and lake water quality are described in chapter 5.4, impacts from agriculture and urban areas in chapter 5.3.1.

Effluents from fish farms can also contribute to fresh water pollution. They contain low concentrations of pollutants, but have high flow rates leading to high nutrient inputs (N and P) into water bodies (Naylor et al., 2003; Foy & Rosell, 1991). They can further lead to an increase in alkalinity, total hardness, BOD<sub>5</sub>, TSS and mesophilic bacteria and a decrease in DO concentration. Often, chemicals and drugs against parasites and pathogenic bacteria also are introduced (Boaventura et al., 1997).

### 5.3.2 Storm water

Storm water is water from rainfall or snowmelt. In areas with impervious surfaces or in the case of exceeded intake capacity of the soil, storm water flows off as surface run-off (US EPA, 2014). In urban areas, storm water management is an integral part of civil engineering and is necessary to prevent flooding, erosion and water quality problems (Adams, 2000). Storm water often is an abundant and relatively unused resource that can make a valuable contribution to city water supplies while reducing impact on the waterways it is currently led into. Since storage is often the limiting factor of storm water harvest and usage, MAR offers a viable and economical solution for its storage and treatment (Dillon et al., 2009a; CSIRO, n.d.).

Storm water can be drained to aquifers via infiltration basins, sumps or wells for subsequent reuse as drinking water or irrigation supply (Dillon, 2005). Storage inside an aquifer for a year, has allowed storm water to be used as drinking water without any further treatment. In other cases, for example when recharging a brackish limestone aquifer, constructed wetlands have been used as suitable pre-treatment for recovery as irrigation water without any further treatment (Dillon et al., 2009a).

Of concern is the content of contaminants that can be found especially in urban run-off. While flowing off, run-off can collect debris, chemicals, sediment and other pollutants (US EPA, 2014). Common constituents include different forms of nitrogen and phosphorus, TSS, volatile suspended solids (VSS), COD and heavy metals like lead and zinc (Brezonik & Stadelmann, 2002).

#### 5.4 Treated waste water

Treated waste water is an abundant water source in urban areas, which, with proper treatment, can be used as drinking water, for industrial use, irrigation and environmental purposes (Dillon et al., 2009a). In direct reuse treated waste water is introduced directly, either with or without an engineered storage buffer, into a water treatment plant. In indirect reuse treated waste water is used for augmentation of a water source like surface or groundwater, thereby providing an additional environmental buffer before water treatment (USEPA, 2012).

Water stress due to water quality degradation and water scarcity is a matter of serious concern to municipalities, industries, agriculture and the environment in many countries. With appropriate treatment for the intended end-use, reclamation and reuse of municipal waste water can present a sustainable alternative water source (Wintgens et al., 2008; Asano & Cotruvo, 2004) that is additionally reducing nutrient loads on recipient water bodies (US EPA, 2012). Several treatment facilities exist for the reuse of reclaimed water. The Torreele Plant in Belgium is an established water reclamation plant using waste water effluent for aquifer recharge and subsequent drinking and environmental purposes. In contrast to the use of storm water for aquifer recharge, reclaimed water offers the advantage of very stable flows (Dillon et al., 2009a).

Aquifer storage can serve as temporary storage for reclaimed water providing additional treatment during soil and sub-soil passage, especially in the vadose zone, and/or by aquifer residence time (Dillon et al., 2009a; Ternes et al., 2007) with the additional benefit of increasing public acceptance (Asano et al., 2007; Leviston et al., 2006). Several types of viruses, protozoa and bacteria as well as DOC, nitrogen and labile organic matter can be degraded by microorganisms present in the soil and the aquifer. Their degradation is strongly influenced by the redox state in the aquifer and by the presence of microorganism populations. Although attenuation is also achieved by adsorption, this mechanism is not considered sustainable, because contaminants and pathogens are not retained once the sorption sites become fully occupied (Dillon et al., 2008; Amy & Drewes, 2007; Ternes et al., 2007).

In a SAT system with suitable hydrogeological conditions primary treatment, a stabilization pond and dissolved air flotation can suffice as pre-treatment for municipal waste water, if retention time is kept long enough and only part of the natural aquifer is used for recharge. The pre-treatment processes need to ensure low algal concentrations in the influent in order to avoid clogging of the infiltration basins. Direct injection of reclaimed water requires extensive pre-treatment including MF, RO and disinfection processes to avoid contamination of the aquifer and to ensure adequate end water quality (Dillon et al., 2009a; Asano & Cotruvo, 2004).

Of special concern in MAR projects are pathogens, mineral content, nutrients, metals, pesticides, EDC, pharmaceutically active compounds (PhAC), personal care products (PCP) and other stable and potentially toxic organic substances (WRRF, 2007; Asano & Cotruvo, 2004). Other parameters that have to be taken into consideration with the use of reclaimed water are pH, EC, BOD<sub>5</sub>, COD, DO, adsorbable organic halogen

compounds (AOX), TSS, active chlorine, chloride, sulphate, fluor, surfactants, mineral oil compounds, chloride solvents, disinfection by-products and complex-forming substances (Salgot et al., 2006). Concentrations of viruses and protozoa are of particular concern and need to be controlled and monitored, even if the product water meets the microbiological requirements for drinking water. This is mainly due to the fact that typical microbiological indicators are not adequate for reclaimed water, in which pathogen concentrations are much higher than even in heavily polluted natural waters (Asano & Cotruvo, 2004).

Of further concern for human and environmental health is the content of organic matter in waste water effluents. Effluent organic matter (EfOM) is composed of (i) refractory compounds, (ii) residual degradable substrates, (iii) intermediates, (iv) complex organic compounds and (v) soluble microbial products (SMP) (Barker & Stuckey, 1999). SMP are biodegradable products from substrate metabolism and biomass decay, which are major membrane foulants (Jarusutthirak & Amy, 2006), can lead to bacterial regrowth in the water distribution system and to the formation of disinfection by-products (Amy & Drewes, 2007). EfOM also contains micropollutants like PhAC, EDC and PCP, many of which are not or only partly transformed during municipal waste water treatment. They require advanced treatment, for example with advanced oxidation processes (AOP), in order to prevent accumulating concentrations in drinking water supplies and in the environment (Maeng et al., 2011).

The socio-cultural context needs also be considered with regard to the choice of appropriate technical solutions for the use of reclaimed water (Bixio et al., 2005; Asano et al., 2007).

### 5.5 Pre-treatment methods during MAR in relation to source water and end-use

Table 5-6 shows possible pre-treatment steps and their removal efficiencies for contaminants of main concern as well as removal efficiencies in the MAR systems for artificial recharge and recovery (ARR) and SAT as described by Sharma et al. (2015a). This table is intended for the selection of appropriate pre-treatment steps with ARR and SAT. Its use as well as possible post-treatment steps are described in detail by Sharma et al. (2015a). The list of pre-treatment steps for ARR systems has been supplemented with additional steps and preventive measures as suggested in the Australian Guidelines for Managed Aquifer Recharge (NRMCC, EPHC, & NHMRC, 2009).

**Table 5-6: Matrix for selection of appropriate pre-treatment options for ARR and SAT (Sharma et al., 2015a; NRMCC, EPHC, & NHMRC, 2009).**

Pollutants to be removed	Pre-treatment and preventive measure		Removal efficiency for ARR	Removal efficiency of SAT**		
	Type	Removal Efficiency		PE	SE	TE
Pathogens	Chlorination	1-4 Log	1-<8.3 Log (regulated by residence time)	PE	>1 - 6.9	
	UV	1-4 Log		SE	0 - 6.5	
	Ozonation	1-4 Log		TE	0.4 - 4.0	
	MF/UF	0-7 Log	n.a.			
Hardness	Lime softening	60%	-	PE	-	Only post-treatment
	NF	85-99%		SE	-	
				TE	-	
Turbidity	Sedimentation + Aeration + Rapid Sand Filter /Slow Sand Filter	>95-100%	50-100%	n.a.		
	MF	>98%				
	Wetlands	n.s.				
	UF	>98%		PE	50-100%	

Pollutants to be removed	Pre-treatment and preventive measure		Removal efficiency for ARR		Removal efficiency of SAT**		
	Type	Removal Efficiency					
	Coagulation+ Sedimentation	>95%			SE	50-100%	
					TE	50-100%	
TSS	Sedimentation + Aeration + RSF/SSF	100%	90-100%		n.a.		
	UF	85-99.9%			PE	86-100%	
	Coagulation+ Sedimentation	50->85%			SE	>90-100%	
	Aeration+RSF	70-80%	n.a.	TE	>90-100%		
Iron/ Manganese	Aeration + RSF	Fe	92-97%	-	PE	-	Only post-treatment
		Mn	17-79%		SE	-	
	Aeration + RSF + Aeration + RSF	Fe	>99%		TE	-	
		Mn	31-96%				
	Coagulation + Flocculation + Filtration	n.s.					
	Ph and Eh adjustment in source water	n.s.					
Fluoride	-	-	-	Only post-tr.	n.a.		
Arsenic	Control of Eh	n.s.	90%		n.a.		

Pollutants to be removed	Pre-treatment and preventive measure		Removal efficiency for ARR	Removal efficiency of SAT**	
	Type	Removal Efficiency			
	during recharge				
Nitrate	Ion exchange	90%	50-100%	PE	57-100%
				SE	3 - >90%
	RO	65 - >95%	n.a.	TE	0-22%
	Activated sludge	n.s.	50-100%	n.a.	
	Biofiltration	n.s.			
	Wetlands	n.s.			
Ammonium	Chlorination	100%	53-90%	n.a.	
	Aeration + RSF	40-50%			
	NF/RO	90-98%	n.a.	PE	25-99%
				SE	0-99%
			TE	17-100%	
Organic micro-pollutants (highly dependent on type of pollutant)	Ozonation	50->90%	≥50%	n.a.	
	GAC	0-70%			
	Exclude prone sub-catchments	n.s.			
	UF	>90%	n.a.	PE	75-100%
	RO	70-99.9%		SE	20-100%
				TE	10-100%
Colour	Aeration +	>60-64%	50-100%	n.a.	

Pollutants to be removed	Pre-treatment and preventive measure		Removal efficiency for ARR		Removal efficiency of SAT**		
	Type	Removal Efficiency					
	Coagulation + RSF						
	GAC	<55%					
Salinity	Increase volume of recharged fresh water	n.s.	-	Only post-treatment	PE	-	Only post-treatment
					SE	-	
					TE	-	

\*\* PE = primary effluent; SE = secondary effluent; TE = tertiary effluent

n.a. = method not applied to this recharge system

n.s. = values not specified

Only post-treatment = parameter reduction is performed only in post-treatment steps

Pre-treatment methods during MAR improve the quality of water prior to recharge. Their choice and necessity is determined by the factors described above. Pre-treatment steps applied by MAR sites in Europe for different water sources and water end-uses will be described in chapters 5.5.1 to 5.5.3. In Table 5-7, Table 5-8 and Table 5-9, the European sites are summarized and an overview of the different pre-treatment methods is given.

### 5.5.1 MAR sites producing water mainly for environmental benefits

Environmental benefits are here defined in a broad sense and include MAR sites without a clear recovery concept. Recovery of the recharged water takes place by various end-users, which may include agriculture, ecology, industry or drinking water supply.

#### Llobregat aquifer, Spain –Basin infiltration

With the growth of the Barcelona area, the Llobregat Delta Aquifer, an important water supply in times of dry periods, has been exceedingly used, leading to decreasing groundwater levels and sea water intrusion into the aquifer. In the last 40 years, several projects have been launched to guarantee good groundwater quality and the sustainable use of the aquifer. Aquifer recharge allows the storage of excess water to cover water demand in dry periods while at the same time providing water purification by soil passage and aquifer residence time (Hernández et al., 2011).

Infiltration basins have been constructed at three sites along the course of the Llobregat River. Sant Vicenç dels Horts is constructed both for the use of river water and for reclaimed water from the El Prat del Llobregat Tertiary Treatment Plant (Hernández et al., 2011), where secondary effluent of El Prat WWTP is



treated by ballasted coagulation-flocculation, lamellar decantation, surface filtration and UV and chemical disinfection (Cazurra, 2008; Aguiló et al., n.d.). Secondary treatment at the WWTP includes screening, elimination of sand and oil in desanders-deoilers, primary clarification, activated sludge with anaerobic, anoxic and oxygenation processes and secondary clarification (Acciona Agua, n.d.). Currently, the recharge sites are operated only with river water. Sole pre-treatment before infiltration is sedimentation in clarification ponds. An automated system regulates the recharge volume according to river water flow rate. To minimize clogging, water quality is monitored for turbidity, conductivity and ammonium. Estimated recharge volume is 6 to 10 Mio. m<sup>3</sup> per year.

#### Llobregat aquifer, Spain – Deep well injection

In the Llobregat Delta in Spain, intensive groundwater exploitation and excavation of part of the confining layer of the aquifer has led to increasing sea water intrusion since the 1960s into an aquifer, which is used for industrial, agricultural and drinking water purposes (Custodio, 1981, 2008, 2010; Iribar, 1992; Iribar & Custodio, 1992). As one of the measures to mitigate water scarcity and ameliorate aquifer quality, an injection hydraulic barrier was constructed (Ortuño et al., 2008), injecting reclaimed water from the Baix (El Prat) Llobregat waste water treatment and reclamation plants (WWTP and WRP) (Cazurra, 2008; Aguiló et al., n.d.). At the WWTP municipal waste water is treated by screening, elimination of sand and oil in desanders-deoilers, primary clarification, activated sludge with anaerobic, anoxic and oxygenation processes and secondary clarification (Acciona Agua, n.d.). The secondary effluent is further purified in the El Prat WRP by ballasted coagulation-flocculation, lamellar decantation, surface filtration and UV and chemical disinfection (Cazurra, 2008; Aguiló et al., n.d.). At the hydraulic barrier plant, the WWTP effluent is treated by UF, RO and UV disinfection prior to injection. UF is applied to maintain stable microbiological water quality, to prevent clogging of the injection wells and to reduce fouling of the RO membranes. RO is needed to reduce salinity mainly due to former and current upstream potash mine activity. According to Spanish law, EC, pH, temperature, ammonia, turbidity, biological and chemical parameters, major elements, metals, volatile organohalogenated and organochlorine compounds are monitored.

The treated water is injected into the confined, lower sand and gravel aquifer through 15 wells, which are placed 1 km inland and parallel to the shore and which cover the whole depth of the aquifer. Abstracted water is mainly used for urban and industrial supply. At the same time, it serves as an emergency water supply for the city of Barcelona.

The project was successful in rising groundwater levels and reducing salt concentrations in the aquifers without experiencing any negative effect on injection capacity due to clogging up to date (Ortuño et al., 2012; Hernández et al., 2011).

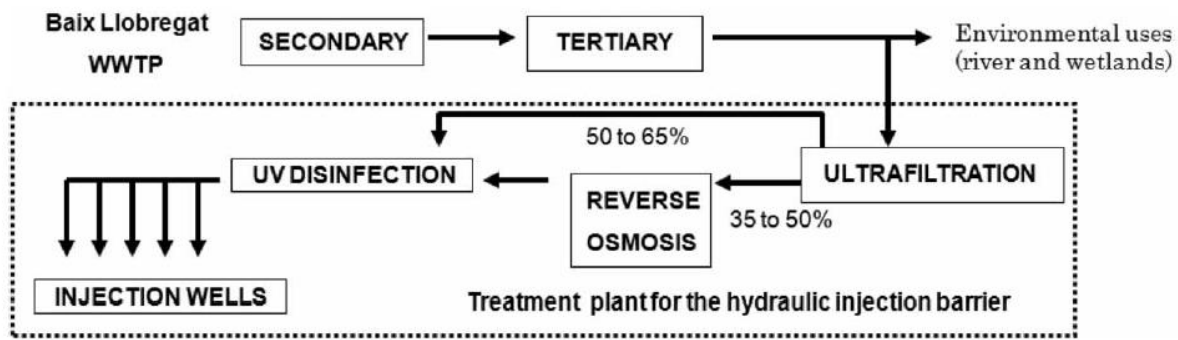

Figure 5-3: Waste water treatment system prior to injection into the aquifer of Baix Llobregat WWTP and WRP (Ortuño et al., 2012)

Hessisches Ried, Germany – sprinkler irrigation and various infiltration techniques

At the “Hessisches Ried” area in Germany treated Rhine River water is used for sprinkler irrigation and groundwater replenishment. Groundwater replenishment takes place through a series of recharge shafts, infiltration wells and open channels. Groundwater replenishment aims at i) compensating seasonally occurring groundwater deficits ii) realizing ecological benefits and iii) securing drinking water supply (WHR, 2008). Through a sequence of technical treatment steps the infiltrated water quality meets drinking water standards.

Table 5-7: Overview of pre-treatment methods used for MAR types producing water for multi purposes without managed abstraction scheme

MAR type	Source water type	Pre-treatment	Case study	References
Pond infiltration	(1) River water (Llobregat River); (2) Reclaimed water	(1) Clarification pond (2) Screening, desanders-deoilers, primary clarification, activated sludge, secondary clarification  Coagulation-flocculation, lamellar decantation, surface filtration and UV, chemical disinfection	Llobregat Delta, Spain	Acciona Agua, n.d.; Aguiló et al., n.d. ; Cazurra, 2008; Hernández et al., 2011; Ortuño et al., 2009
Deep well injection	Reclaimed water	Screening, desanders-deoilers, primary clarification, activated sludge, secondary clarification	Barrera hidraulica del Llobregat, Barcelona (Spain)	Acciona Agua, n.d. ; Aguiló et al., n.d.; Cazurra, 2008 ; Hernández et al.,

		Coagulation-flocculation, lamellar decantation, surface filtration, UV and chemical disinfection UF, RO, UV disinfection		2011; Ortuño et al., 2012; Teijón et al., 2009;
<b>Different infiltration techniques (recharge shafts, infiltration wells and open channels)</b>	River water	Screening, pre-ozonation, flocculation, sedimentation, ozonation, secondary flocculation, filtration, activated carbon	Hessisches Ried (Germany)	WHR 2008

### 5.5.2 MAR sites producing water mainly for agricultural purposes

#### Nardò, Italy – Sinkhole infiltration

In Nardò, MAR is used for further treatment of secondary effluent from municipal waste water treatment plants. The waste water is treated with activated sludge and the effluent is transported to the MAR area by an open channel (Asso channel) and infiltrated into the unconfined karstic aquifer by a sinkhole with an average flow rate of about 150 l/s (La Mantia et al., 2008). The water is extracted through recovery wells at distances of 600 to more than 3'000 m from the injection area, resulting in an average residence time of 20 to 25 days. With 1.7 Mio.m<sup>3</sup> per year about 1/3 of the injected water is recovered and is used for unrestricted irrigation without post-treatment. In Nardò, the MAR system is the critical barrier for the limitation of human health risks due to viruses, bacteria and protozoa. Acceptable risk levels with regard to aerosol ingestion could be reached only by replacing sprinkler by drip irrigation (Ayuso-Gabella et al., 2011).

#### Valld'Uixó, Castellon (Spain) – Well injection

The recently constructed reservoir in la Valld'Uixó allows the storage of 2 Mm<sup>3</sup> of surplus water of the Belcaire River to be injected into the aquifer in drought periods. Public and private entities joined efforts to carry out the first pilot test by injecting 310'000 m<sup>3</sup> in 2013 and 2014 using two injection wells of 100 m depth. DEMEAU project collaborated in the assessment of the use of reclaimed water from the local waste water treatment plant as an alternative source of recharge water to be implemented in a future stage. The area is subject to salinity ingress and the main objective of well injection is to counteract salinity ingress. Main end-user is the local agriculture (Morell et al., 1996).

**Table 5-8: Overview of pre-treatment methods used for MAR types producing water for (restricted) agricultural purposes**

MAR type	Source water type	Pre-treatment	Case study	Reference
----------	-------------------	---------------	------------	-----------

<b>Sinkhole infiltration</b>	Reclaimed water	Activated sludge, sedimentation	Nardo, Italy	Ayuso-Gabella et al., 2011 La Mantia et al., 2008
<b>Well injection</b>	River water	Clarification pond	Valld'Uixó, Castellon	Morell et al. (1996)

### 5.5.3 MAR sites producing drinking water

#### Lange Erlen, Basel, Switzerland – Forested soil infiltration

Since 1964 water has been diverted from the river Rhine to augment groundwater supplies in Basel for subsequent extraction as drinking water. The system covers about half of the drinking water demand of the city of Basel. The water is caught above the power plant Birsfelden and led onto embanked natural forest sites on former alluvial soils. After passing a coarse screen, the water is treated by rapid sand filtration, which removes about 95% of suspended solids. An average of 60'000 m<sup>3</sup> per operating day of the pre-filtered water is led onto several of the 11 watering infiltration sites (total size about 13 ha) inside of the forest. The system is operated during 9 months per year. In general, a watering site is flooded for 10 days followed by a 20 day drying period. By passing the different soil horizons the river water is purified, but in contrast to slow sand filter systems no biofilm is generated. After a horizontal flow distance of about 200 to 800 m in the aquifer, the water is recovered by 11 wells. It is of high drinking water quality and only adjusted for pH and treated with chlorine dioxide to prevent re-growth of microorganisms before it is fed into the distribution network.

On a yearly basis, the extracted volume is about equal to the infiltrated volume. Infiltration and purification capacities (i.e. removal of dissolved organic carbon) have remained constant and satisfactory since establishment of the system. Apart from the drying phases, no regeneration or maintenance measures are necessary (Rüetschi, 2004).

#### The Hague, The Netherlands – Dune filtration and ASTR

A main source of fresh groundwater is found in the sandy dunes along the coast, where it has been used for drinking water purposes since 1854. Fresh water occurs in the dunes in reservoirs, which are fed by infiltration of rain water that, due to density differences, forms a fresh water lens on the sea water that infiltrates further below. Because of over-use of these water reserves, several water utilities have started recharging the reservoirs with river or lake water.

*The Dune Water Company of South-Holland (DZH)* uses pre-treated water from the river Meuse for dune infiltration through open ponds or deep wells and subsequent drinking water supply in the region of the Hague, providing a total of about 83 Mio. m<sup>3</sup> per year through three facilities.

*Waternet* uses pre-treated Rhine water from the Lekkanaal in Nieuwegein to replenish dune fresh water supplies through 40 infiltration ditches, providing the city of Amsterdam with about 70 Mio. m<sup>3</sup> per year of drinking water.

*PWN* in the North-Holland province uses pre-treated raw water from the Lekkanaal and from Lake IJsselmeer in Andijk for infiltration through open ponds or deep wells. The abstracted water (about 47 Mio. m<sup>3</sup> per year) is treated and mixed with hyperfiltration water from a membrane filtration plant using pre-treated surface water for supply of consumers in the region.

Pre-treatment includes microsieving to remove suspended solids and mussel larvae, coagulation, flocculation and sedimentation for removal of suspended solids, phosphates, heavy metals, microorganisms and organic matter, and rapid sand filtration for removal of further suspended solids and reduction of organic matter, iron, manganese, ammonium and algae concentrations. Organic micropollutants are monitored or removed by activated carbon filtration at one site of the DHZ.

Deep well infiltration (ASTR) is used for recharge of confined aquifers. These aquifers are without contact to the phreatic water, which reduces environmental impact due to eutrophication. This method needs close control of infiltration water quality to prevent clogging of the wells. After a residence time of about 30 to 60 days the water is extracted using closed systems such as wells, drainage and transport pipes except for one Waternet plant, where a closed system is not feasible. There, an open abstraction, collection and transport system is used.

The abstracted water is aerated and softened. A rapid sand filtration is used to remove oxidized species of iron and manganese resulting from the aeration process, suspended solids and algae. Activated carbon is used in final treatment before sand filtration in the plants without activated carbon in the pre-treatment, reducing concentrations of organic micropollutants and taste and odour. Waternet applies an additional ozonation step for oxidation of organic micropollutants and as disinfection for the open abstraction system. Finally, slow sand filtration decimates bacteria and viruses and removes remaining suspended solids (Tielemans,2007).

#### Berlin-Tegel, Germany – Bank filtration and basin infiltration

In Berlin, all drinking water is produced from local groundwater resources, which are being recharged by bank filtration and basin infiltration (Ziegler, 2001). About 70 % of the drinking water is produced via bank filtration (56%) and artificial groundwater recharge (14%) (BWB, 2003). Because of the high content of waste water effluent in some of the used water bodies, the drinking water system in Berlin can be partially considered an indirect waste water reuse system (Ziegler, 2001).

Tegel Water Treatment Plant (WTP Tegel) is one of the largest water treatment plants in Berlin extracting about 50 Mio. m<sup>3</sup> per year (1998). With 14 to 28%, drinking water of WTP Tegel has the highest fraction of reused wastewater among Berlin's WTPs. Waste water effluent from the WWTP Schönerlinde is discharged into the Nordgraben upstream of Lake Tegel, resulting in lake water with a waste water portion of 10 to 30% and a partially closed water cycle (Fritz et al., 2002; Ziegler, 2001). The waste water of WWTP Schönerlinde is treated in a traditional nitrification/denitrification activated sludge process with phosphate elimination. In 1985, a surface water treatment plant (SWTP Tegel) with flocculation, sedimentation and filtration processes was installed upstream of Lake Tegel to add to the purification processes of the WWTP for the removal of phosphorus by Fe<sub>2</sub>(SO<sub>4</sub>)<sub>3</sub> flocculation and of remaining filterable compounds resulting in very clean water entering Lake Tegel (BWB, n.d.).

Water is extracted through eight well galleries around Lake Tegel with a total of 130 vertical and one horizontal well. Three of the galleries are affected by artificial groundwater recharge, which is infiltrated via infiltration basins (30'069 m<sup>2</sup> total) (BWB, 2014; Ziegler, 2001). About 80% of the groundwater abstracted consists of bank filtrate and artificially recharged water (Ziegler, 2001).

Pre-treatment for groundwater recharge consists of microsieving to reduce clogging of the infiltration basins. Nevertheless, the top layer of the sandy soil needs to be removed from time to time, to guarantee sufficient permeability. The infiltration basins are usually cleaned once a year by drying up the basins and removing the upper sand layer for washing (Ziegler, 2001). The retention time in the aquifer is about 50 days, which allows recovery of the groundwater without any microbiological problems and distribution without disinfection. After extraction the groundwater is only aerated for iron and manganese oxidation and filtered by rapid filtration (Grünheid et al., 2005). The long-lasting and stable purification capacity and low energy and maintenance requirements result in a very sustainable water supply system. Problems with regard to the self-purification capacity of the system can emerge related to persistent, polar organic compounds, though (Ziegler, 2001).

#### Torreele, Belgium – Dune filtration

In the Veurne region in the Northern part of Belgium, dune water has been used since World War I. Dune water extraction is limited, though, because of the presence of salt water north and south of the dunes. Over-extraction of dune water will lead to saline water intrusion into the dunes. To comply with the increasing drinking water demand in the region, the Torreele project was started, using treated, mainly domestic waste water for groundwater recharge.

The Torreele plant, operated by the Intermunicipal Water Company of Veurne-Ambacht (IWVA, n.d.) since 2002, has a treatment capacity of 2.5 Mio. m<sup>3</sup> infiltration water per year, which corresponds to about 40% of the drinking water demand of the region. Infiltration water is taken directly from the local waste water treatment plant (WWTP) Wulpen (Van Houtte et al., 2005; IWVA, n.d.). The waste water is treated in a conventional pre-denitrification activated sludge process with mechanical pre-treatment and P and N removal (Kazner et al., 2012). The WWTP effluent is treated with a prescreening, MF, cartridge filter, RO with subsequent chemical re-mineralization and UV radiation (Figure 5-4) before it is fed into the sandy unconfined aquifer through an infiltration pond of 18'200 m<sup>2</sup> in the catchment area. To completely capture the infiltrated water, the 112 extraction wells are placed around the infiltration area. Residence time is a minimum of 40 days. After extraction, the water is aerated and filtered by sand filtration for removal of iron and manganese.

To protect the dune area, strict environmental standards are applied and no untouched dunes were accessed (Van Houtte et al., 2005; IWVA, n.d.).

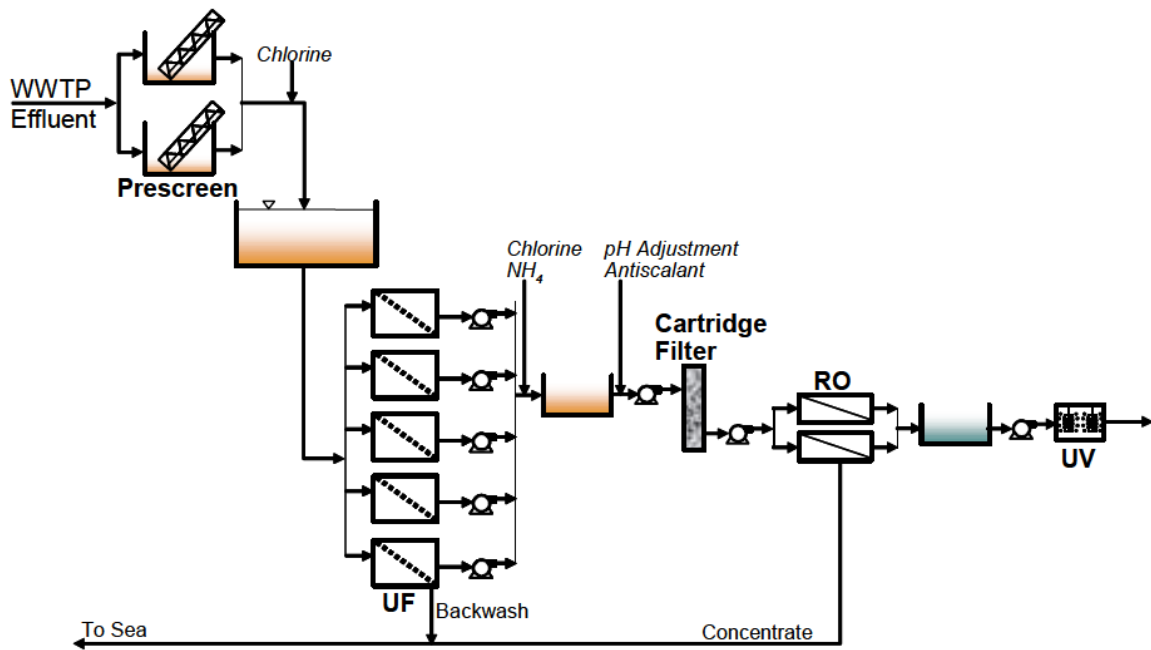

Figure 5-4: Process scheme of pre-treatment at Torreele plant (van Houtte and Verbauwheide, 2008)

Table 5-9 Overview of pre-treatment methods used for MAR types producing drinking water

MAR type	Source water type	Pre-treatment	Case study	Reference
<b>Forested soil infiltration</b>	River water (Rhine)	Rapid sand filtration	Basel (Lange Erlen), Switzerland	Rüetschi, 2004
<b>Dune infiltration + well injection</b>	River water (Meuse, Rhine),	Microsieving, coagulation, flocculation, sedimentation, (activated carbon filtration), rapid sand filtration	The Hague, Scheveningen-Waalsdorp, The Netherlands	Tielemans, 2007
<b>Bankfiltration, Pond infiltration</b>	Lake water (Lake Tegel) with 10 - 30 % treated effluent	Activated sludge, N and P removal (WWTP) Flocculation, sedimentation and filtration (SWTP) Microsieving	Berlin-Tegel, Germany	BWB, 2003; Fritz et al., 2002; Grünheid et al., 2005; Ziegler, 2001
<b>Dunefiltration, ASTR</b>	Reclaimed water	Screening, sand trap, activated sludge, N and P removal  Pre-screening, MF, cartridge filtration, RO with re-mineralization, UV irradiation	Torreele, Belgium	Van Houtte et al., 2005

## 5.6 Summary of pre-treatment methods at selected European MAR sites

Figure 5-5 displays the various pre-treatment methods used in European MAR systems in relation to the different water sources and end-uses of MAR product water for the main categories environmental use (Table 5-7), agricultural (Table 5-8) and drinking water (Table 5-9).

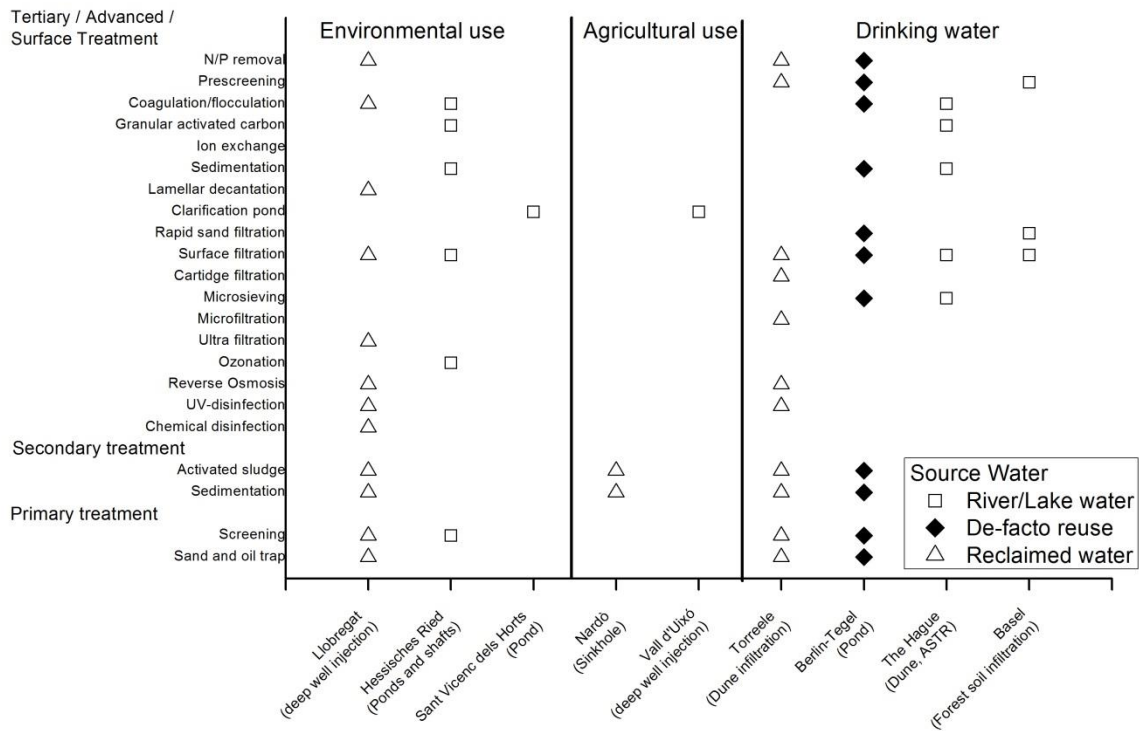

Figure 5-5: Typical pre-treatment methods in relation to the water end-use and the source water based on case studies from European MAR sites (Belgium, Germany, Italy, Netherlands, Spain and Switzerland)

## 5.7 Conclusions

River and lake water, storm water and waste water effluents are suitable, valuable and often sustainable and economical sources for MAR. Depending on source water quality pre-treatment requirements differ. Ambient groundwater quality, hydrogeological conditions, process conditions in the aquifer, intended end-use, the MAR system used, local water quality guidelines and public acceptance are additional factors, which need to be considered when choosing appropriate pre-treatment systems. Often, several treatment steps are necessary to achieve and secure the required product water quality and to provide a uniform water quality for the next treatment step to protect downstream technology (Sharma et al., 2015a; Dillon et al., 2009b; Dillon et al., 2008; Asano & Cotruvo, 2004).

Pre-treatment is necessary to remove critical contaminants from the source water, to enhance system performance and removal efficiencies, to ensure the long-term functioning of the system, to meet regulatory demands in current and future conditions, to ensure beneficial uses of the aquifer beyond as well as, on cessation of aquifer use for water treatment, future beneficial uses within the attenuation zone (Sharma, 2015b; Dillon et al., 2008; Asano & Cotruvo, 2004).



Reclaimed water needs much more advanced pre-treatment than surface water. Higher level pre-treatment is necessary especially in the case of high quality native groundwater, high quality product water and in fine-grained aquifers (Dillon et al., 2009). This is also apparent in the choice of pre-treatment steps at the European MAR sites. MAR systems can provide a certain degree of treatment during soil and sub-soil vadose zone passage and by aquifer residence time (Dillon et al., 2009a; Ternes et al., 2007) resulting in lower pre-treatment requirements. Removal of viruses, protozoa and bacteria, DOC, nitrogen and some trace organics by natural attenuation processes has been shown to be effective (Dillon et al., 2008; Amy & Drewes, 2007; Ternes et al., 2007).

MAR systems can be used as treatment of surface water with only little pre-treatment, as seasonal storage for times of water scarcity and/or to counteract salt water intrusion (Asano & Cotruvo, 2004). Aquifer storage can be part of civil engineering effort in storm water management to prevent flooding, erosion and water quality problems (Adams, 2000) and reduce the impact on the waterways it is currently led into (CSIRO, n.d.). Under favorable conditions (e.g. long residence times) only little or no additional treatment might be necessary before end-use (Dillon et al., 2009a).

Waste water is an abundant resource with stable flows, which has been successfully used in several MAR systems. It can be reclaimed with appropriate and usually advanced treatment (Dillon et al., 2009a; Wintgens et al., 2008; Asano & Cotruvo, 2004). With the use of reclaimed water the main concerns are microbiological quality, total mineral content, presence of heavy metal toxicants and concentrations of stable and possibly harmful organic substances (WRRF, 2007; Asano & Cotruvo, 2004). With knowledge of source water and intended end-use, appropriate pre-treatment methods can be assessed using Table 5-6.



## References

- Acciona Agua (no date). *WWTP Baix Llobregat*. Retrieved on March 3, 2015, from <http://www.acciona-agua.com/activities/wastewater-/wwtp-baix-llobregat.aspx?actividad=0>
- Adams, B.J. (2000). *Urban storm water management planning with analytical probabilistic models*. New York (USA): John Wiley and Sons, Inc.
- Aguiló, P., Sanz, J., Curto, J., Martínez, B., & Gullón, M. (no date). *El Prat de Llobregat Water Reclamation Plant: Reclaimed Water Quality and Reliability*. Retrieved on January 16, 2015, from [http://www.veoliawatertechnologies.es/vwst-iberica/ressources/documents/1/25299,PRAT\\_LLOBREGAT\\_IWACONGRESS-ON-WATE.pdf](http://www.veoliawatertechnologies.es/vwst-iberica/ressources/documents/1/25299,PRAT_LLOBREGAT_IWACONGRESS-ON-WATE.pdf)
- Al-Rekabi, W.S., Qiang, H., & Qiang, W.W. (2007). Improvements in Waste water Treatment Technology. *Pakistan Journal of Nutrition*6(2), 104–110. doi:10.3923/pjn.2007.104.110
- Amy, G., & Drewes, J. (2007). Soil aquifer treatment (SAT) as a natural and sustainable waste water reclamation/reuse technology: fate of waste water effluent organic matter (EfOM) and trace organic compounds. *Environmental Monitoring and Assessment*, 129(1-3), 19–26. doi:10.1007/s10661-006-9421-4
- Asano, T., Burton, F.L., Leverenz, H.L., Tsuchihashi, R. & Tchobanoglous, G. (2007). *Water Reuse: Issues, Technologies and Applications*. New York (USA): McGraw Hill.
- Asano, T., & Cotruvo, J. (2004). Groundwater recharge with reclaimed municipal waste water: health and regulatory considerations. *Water Research*38(8), 1941–51. doi:10.1016/j.watres.2004.01.023
- Ayuso-Gabella, N., Page, D., Masciopinto, C., Aharoni, A., Salgot, M., & Wintgens, T. (2011). Quantifying the effect of Managed Aquifer Recharge on the microbiological human health risks of irrigating crops with recycled water. *Agricultural Water Management*, 99(1), 93–102. doi:10.1016/j.agwat.2011.07.014
- Balke, K. D., & Zhu, Y. (2008). Natural water purification and water management by artificial groundwater recharge. *Journal of Zhejiang University Science B* 9(3), 221–226.
- Barker, D.J., & Stuckey, D.C. (1999). Review Paper - A Review of Soluble Microbial Products (SMP) in Waste water Treatment Systems. *Water Research*33(14), 3063–3082.
- Berliner Wasser Betriebe (Berlin Water Works–BWB) (2003). <http://www.bwb.de>.
- Berliner Wasser Betriebe (Berlin Water Works – BWB) (2014). *Wasserwerk Tegel*. Retrieved on January 5, 2015, from [http://www.bwb.de/content/language1/downloads/WW\\_Tegel.pdf](http://www.bwb.de/content/language1/downloads/WW_Tegel.pdf)
- Berliner Wasser Betriebe (Berlin Water Works – BWB) (no date). *Berlins Seen lassen tief blicken*. Retrieved on April 25, 2015, from <http://www.bwb.de/content/language1/html/6379.php>

- Bixio, D., DeHeyder, B., Cikurel, H., Muston, M., Miska, V., Joksimovic, D., Schäfer, A.I., Ravazzini, A., Aharoni, A., Savic, D., & Thoeve, C. (2005). Municipal waste water reclamation: where do we stand? An overview of treatment technology and management practice. *Water Science & Technology: Water Supply* 5(1), 77–85.
- Boaventura, R., Pedro, A. M., Coimbra, J., & Lencastre, E. (1997). Trout farm effluents: characterization and impact on the receiving streams. *Environmental Pollution* 95(3), 379-387.
- Bouwer, H. (2002). Artificial recharge of groundwater: hydrogeology and engineering. *Hydrogeology Journal* 10(1), 121–142. doi:10.1007/s10040-001-0182-4
- Brezonik, P.L. & Stadelmann, T.H. (2002). Analysis and predictive models of storm water runoff volumes, loads, and pollutant concentrations from watersheds in the Twin Cities metropolitan area, Minnesota, USA. *Water Research* 36(7), 1743–1757.
- Cazurra, T. (2008). Water reuse of south Barcelona's waste water reclamation plant. *Desalination* 218(1), 43–51.
- Council Directive 2006/118/EC on the protection of groundwater against pollution and deterioration, 2006. O.J. L 372/19.
- Council Directive 98/83/EC on the quality of water intended for human consumption, 1998. O.J. L 330/32.
- CSIRO (no date). *Managed Aquifer Recharge and Storm water Use Options Research Project*. National Research Flagships, CSIRO Land and Water. Retrieved on February 26, 2015, from, [www.csiro.au/flagships](http://www.csiro.au/flagships).
- Cunningham, V.L., Buzby, M., Hutchinson, T., Mastrocco, F., Parke, N., & Roden, N. (2006). Effects of human pharmaceuticals on aquatic life: next steps. *Environmental Science Technology* 40(11), 3456–3462.
- Custodio, E. (1981). Sea water encroachment in the Llobregat and Besós areas, near Barcelona (Catalonia, Spain). In: *Sea Water Intrusion Meeting. Intruded and Fossil Groundwater of Marine Origin, Uppsala. Rapporten och Meddelanden* 27, 120-152.
- Custodio, E. (2008). Acuíferos detríticos costeros del litoral mediterráneo peninsular: valle bajo y delta del Llobregat. Monográfico: Las Aguas Subterráneas. Rev. Assoc. Española Enseñanza de las Ciencias de la Tierra. *Madrid* 15(3), 295–304.
- Custodio, E. (2010). Coastal aquifers of Europe: an overview. *Hydrogeology Journal* 18(1), 269–280.
- Daher, W., Pistre, S., Kneppers, A., Bakalowicz, M., & Najem, W. (2011). Karst and artificial recharge: Theoretical and practical problems. *Journal of Hydrology*, 408(3), 189–202. doi:10.1016/j.jhydrol.2011.07.017

- DEMEAU (2012). Seventh Framework Programme. THEME [ENV.2012.6.5-2]. Annex I – Description of work.
- Dillon, P. (2005). Future management of aquifer recharge. *Hydrogeology Journal*, 13(1), 313–316. doi:10.1007/s10040-004-0413-6
- Dillon, P., Page, D., Vanderzalm, J., Pavelic, P., Toze, S., Bekele, E., Sidhu, J., Prommer, H., Higginson, S., Regel, R., Rinck-Pfeiffer, S., Purdie, M., Pitman, C., & Wintgens, T. (2008). A critical evaluation of combined engineered and aquifer treatment systems in water recycling. *Water Science and Technology*, 57(5), 753-762. doi:10.2166/wst.2008.168
- Dillon, P., Pavelic, P., Page, D., Beringen, H., & Ward, J. (2009a). Managed aquifer recharge: An Introduction. *Waterlines Report Series 13*. Canberra (AUS): National Water Commission.
- Dillon, P., Page, D., Pavelic, P., Toze, S., Vanderzalm, J., & Levett, K. (2009b). Australian Guidelines for Water Recycling Managed Aquifer Recharge. *Natural Resource Management Ministerial Council*.
- Drinan, J.E., & Spellman, F.R. (2013). Water and Waste water Treatment – A Guide for the Nonengineering Professional, 2<sup>nd</sup> ed. Boca Raton, Florida(USA): CRC Press.
- EEA (no date). *Water Pollution — Overview*. European Environmental Agency. Retrieved on Novembre 15, 2014, from <http://www.eea.europa.eu/themes/water/water-pollution>
- FAO (2014). *Waste water treatment*. Food and Agricultural Organization of the United Nations, Natural Resources Management and Environment Department. Retrieved on October 31, 2014, from <http://www.fao.org/docrep/t0551e/t0551e05.htm>
- FOEN (2012). *Micropollutants in municipal waste water*. Bern: Federal Office for the Environment FOEN.
- Foy, R. H., & Rosell, R. (1991). Loadings of nitrogen and phosphorus from a Northern Ireland fish farm. *Aquaculture* 96(1), 17-30.
- Fritz, B., Sievers, J., Eichhorn, S., & Pekdeger, A. (2002). Geochemical and hydraulic investigations of river sediments in a bank filtration system. In: Dillon, P.J. (Ed.), *Management of Aquifer Recharge for Sustainability: Proceedings of the 4th International Symposium on Artificial Recharge of Groundwater, ISAR-4, Adelaide, South Australia, 22-26 September 2002*. AA Balkema (AUS), 95–100.
- GE Power & Water (2012). *Chapter 01 – Water Sources, Impurities and Chemistry*. Water & Process Technologies. Retrieved on July 07, 2014, from [http://www.gewater.com/handbook/Introduction/ch\\_1\\_sourcesimpurities.jsp](http://www.gewater.com/handbook/Introduction/ch_1_sourcesimpurities.jsp)
- Ghayoumian, J., Mohseni Saravi, M., Feiznia, S., Nouri, B., & Malekian, A. (2007). Application of GIS techniques to determine areas most suitable for artificial groundwater recharge in a coastal aquifer in southern Iran. *Journal of Asian Earth Sciences* 30(2), 364–374. doi:10.1016/j.jseaes.2006.11.002

- Grünheid, S., Amy, G., & Jekel, M. (2005). Removal of bulk dissolved organic carbon (DOC) and traceorganic compounds by bank filtration and artificial recharge. *Water Research* 39(14), 3219–3228.
- Van Haandel, A.C., & Lettinga, G. (1994). *Anaerobic sewage treatment: a practical guide for regions with a hot climate*. Chichester (UK): John Wiley & Sons.
- Hanchang, S. (no date). *Point sources of pollution local effects and its control*. Industrial Waste water-Types, Amounts and Effects 1. UNESCO-EOLSS. Retrieved on February 27, 2015, from <http://www.eolss.net/sample-chapters/c09/e4-11-02-02.pdf>
- Hannappel, S., Scheibler, F., Huber, A., & Sprenger, C. (2014). Characterization of European Managed Aquifer Recharge (MAR) Sites - Analysis. *DEMEAU*.
- Herberer, T., Mechlinski, A., Fanck, B., Knappe, A., Massmann, G., Pekdeger, A., & Fritz, B. (2004). Field studies on the fate and transport of pharmaceutical residues in bank filtration. *Groundwater Monitoring & Remediation*, 24(2), 70-77.
- Hernández, M., Tobella, J., Ortuño, F., & Armenter, J. (2011). Aquifer recharge for securing water resources: the experience in Llobregat river. *Water Science and Technology : A Journal of the International Association on Water Pollution Research*, 63(2), 220–6. doi:10.2166/wst.2011.036
- Iribar, V. (1992). Evolución hidroquímica e isotópica de los acuíferos del Baix Llobregat. *Doctoral Thesis*. Department of Geochemistry, Petrology and Geology. University of Barcelona (UB).
- Iribar, V., & Custodio, E. (1992). Advancement of seawater intrusion in the Llobregat delta aquifer. In: *Study and Modelling of Salt Water Intrusion*. Barcelona (E): CIMNE–UPC, 35-50.
- IWVA (no date). Torreele - Production of infiltration water out of effluent. IWVA Homepage. Retrieved on January 10, 2015 from [www.iwva.be/docs/torreele\\_en.pdf](http://www.iwva.be/docs/torreele_en.pdf)
- Jarusutthirak, C., & Amy, G. (2006). Role of soluble microbial products (SMP) in membrane fouling and flux decline. *Environmental Science & Technology*, 40(3), 969–74.
- Kazner, C., Wintgens, T., & Dillon, P.J. (2012). *Water Reclamation Technologies for Safe Managed Aquifer Recharge*. London (UK): IWA Publishing.
- La Mantia, R., Masciopinto, C., Levantesi, C., & Tandoi, V. (2008). Fate and transport of faecal contamination microbial indicators, pathogenic protozoa and Campylobacter in the artificially recharged fractured aquifer of Salento, Italy. *Water Science and Technology* 57(6), 849–856.
- Leviston, Z., Nancarrow, B.E., Tucker, D.I. & Porter, N.B. (2006). Predicting community behaviour: indirect potable reuse of waste water through Managed Aquifer Recharge. *CSIRO Land and Water Science Report* 29(06). Retrieved on February 28, 2015, from [www.clw.csiro.au/publications/science/2006/sr29-06.pdf](http://www.clw.csiro.au/publications/science/2006/sr29-06.pdf)

- Lu, J., Zhang, T., Ma, J., & Chen, Z. (2009). Evaluation of disinfection by-products formation during chlorination and chloramination of dissolved natural organic matter fractions isolated from a filtered river water. *Journal of Hazardous Materials* 162(1), 140-145.
- Maeng, S.K., Sharma, S.K., Lekkerkerker-Teunissen, K., & Amy, G. (2011). Occurrence and fate of bulk organic matter and pharmaceutically active compounds in managed aquifer recharge: a review. *Water Research*, 45(10), 3015–33. doi:10.1016/j.watres.2011.02.017
- Morell, I., Giménez, E., Esteller, M.V., (1996). Application of principal components analysis to the study of salinization on the Castellon Plain (Spain). *Science of The Total Environment* 177, 161-171.
- Naylor, S., Brisson, J., Labelle, M. A., Drizo, A., & Comeau, Y. (2003). Treatment of freshwater fish farm effluent using constructed wetlands: the role of plants and substrate. *Water Science and Technology* 48(5), 215-222.
- NRMMC, EPHC, NHMRC (2009). *Australian guidelines for water recycling: managing health and environmental risks (phase 2). Managed aquifer recharge. National water quality management strategy*. Canberra (AUS): Natural Resource Management Ministerial Council, Environment Protection and Heritage Council, National Health and Medical Research Council.
- Ortuño, F., Niñerola, J.M., Teijon, G. & Candela, L. (2008). Desarrollo de la primera fase de la barrera hidráulica contrala intrusión marina en el acuífero principal del Delta delLlobregat. *IX National Symposium on Hydrogeology*, Elche (E).
- Ortuño, F., Niñerola, J.M., Armenter, J.L. & Molinero, J. (2009). Labarrera hidra´ulica contra la intrusión marina y la recarga artificial en el acuífero del Llobregat (Barcelona, España). *Boletín Geologico y Minero* 120(2), 235–250.
- Ortuño, F., Molinero, J., Garrido, T., & Custodio, E. (2012). Seawater injection barrier recharge with advanced reclaimed water at Llobregat delta aquifer (Spain). *Water Science and Technology : A Journal of the International Association on Water Pollution Research*, 66(10), 2083–9. doi:10.2166/wst.2012.423
- Page, D., Wakelin, S., Leeuwen, J.V., & Dillon, P. (2006). *Review of biofiltration processes relevant to water reclamation via aquifers*.CSIRO Land and Water.
- Pavelic, P., Dillon, P., & Nicholson, B.C. (2006). Comparative Evaluation of the Fate of Disinfection Byproducts at Eight Aquifer Storage and Recovery Sites. *Environmental science & technology* 40(2), 501-508.
- Rahman, M.A., Rusteberg, B., Gogu, R.C., Lobo Ferreira, J.P., & Sauter, M. (2012). A new spatial multi-criteria decision support tool for site selection for implementation of managed aquifer recharge. *Journal of Environmental Management*99, 61–75. doi:10.1016/j.jenvman.2012.01.003

- Reed, D.A., Toze, S., & Chang, B. (2008). Spatial and temporal changes in sulphate-reducing groundwater bacterial community structure in response to Managed Aquifer Recharge. *Water Science & Technology* 57(5), 789–795.
- Rüetschi, D. (2004). *Basler Trinkwassergewinnung in den Langen Erlen - Biologische Reinigungsleistungen in den bewaldeten Wässerstellen*. Inauguraldissertation. Philosophisch-Naturwissenschaftliche Fakultät der Universität Basel.
- Salgot, M., Huertas, E., Weber, S., Dott, W., & Hollender, J. (2006). Waste water reuse and risk: definition of key objectives. *Desalination*, 187(1), 29-40.
- Sharma, S.K., Missa, R., Kennedy, M., Sandhu, C., Grischek, Th., & Nätörp, A. (2015a). Chapter 13 - General Framework and Methodology for Selection of Pre- and Post-treatment for Soil/Aquifer-based Natural Treatment Systems. In: Th. Wintgens, A. Nätörp, E. Lakshmanan, & S. R. Asolekar (eds), *Natural Water Treatment Systems for Safe and Sustainable Water Supply in the Indian Context: Saph Pani*. London (UK): IWA Publishing.
- Sharma, S.K., Sandhu, C., Grischek, Th., Gupta, A., Kumar, P., Mehrotra, I., Gruetzmacher, G., Kumar, P.J.S., Lakshmanan, E., & Ghosh, N.C. (2015b). Chapter 12 - Pre- and Post-treatment of BF and MAR in India: Present and Future. In: Th. Wintgens, A. Nätörp, E. Lakshmanan, & S.R. Asolekar (eds), *Natural Water Treatment Systems for Safe and Sustainable Water Supply in the Indian Context: Saph Pani*. London (UK): IWA Publishing.
- Siddiqui, M., Amy, G., Ryan, J., & Odem, W. (2000). Membranes for the control of natural organic matter from surface waters. *Water research* 34(13), 3355-3370.
- Simeonov, V., Stratis, J.A., Samara, C., Zachariadis, G., Voutsas, D., Anthemidis, A., Sofoniou, M., & Kouimtzis, T. (2003). Assessment of the surface water quality in Northern Greece. *Water Research* 37(17), 4119–4124.
- Sprenger, C., Lorenzen, G., Hülshoff, I., Grützmacher, G., Ronghang, M., & Pekdeger, A. (2011). Vulnerability of bank filtration systems to climate change. *Science of the Total Environment* 409(4), 655–663.
- Tchobanoglous, G., Burton, F.L., & Stensel, H.D. (2002). *Waste water Engineering: Treatment and Reuse*. New York (USA): McGraw-Hill.
- Ternes, T.A., Bonerz, M., Herrmann, N., Teiser, B., & Andersen, H.R. (2007). Irrigation of treated wastewater in Braunschweig, Germany: An option to remove pharmaceuticals and musk fragrances. *Chemosphere* 66, 894–904.
- Tielemans, M.W.M. (2007). Artificial recharge of groundwater in the Netherlands. *Water Practice & Technology* 2(3) doi:10.2166/WPT.2007064



- Tong, S.T.Y., & Chen, W. (2002). Modeling the relationship between land use and surface water quality. *Journal of Environmental Management* 66(4), 377-393.
- Toze, S., & Hanna, J. (2002). The Survival Potential of Enteric Microbial Pathogens in a Treated Effluent ASR Project. *Management of aquifer recharge for sustainability*, 139-142.
- Turgut, C. (2003). The contamination with organochlorine pesticides and heavy metals in surface water in Küçük Menderes River in Turkey, 2000–2002. *Environment international* 29(1), 29 – 32.
- US EPA (2011). *Surface Water Contamination*. US Environmental Protection Agency. Retrieved on Novembre 15, 2014, from <http://www.epa.gov/superfund/students/wastsite/srfcspil.htm>
- US EPA (2012). *Guidelines for Water Reuse*. EPA/600/R-12/618. US Environmental Protection Agency. Washington D.C. (USA): U.S. Agency for International Development.
- US EPA (2014). *Storm water Homepage*. US Environmental Protection Agency. Retrieved on Novembre 16, 2014 from <http://water.epa.gov/polwaste/npdes/stormwater/>
- Van der Hoek, J.P., Hofmann, J.A.M.H., & Graveland, A. (2000). Benefits of ozone-activated carbon filtration in integrated treatment processes, including membrane systems. *Aqua- Journal of Water Supply: Research and Technology* 49(6), 341-357.
- Van Houtte, E., Verbauwhe, J., & Driessens, R. (2005). Sustainable groundwater management of a dune aquifer by re-use of waste water effluent in Flanders, Belgium. *Dunes & Estuaries* 2005, 328.
- Van Houtte, E., & Verbauwhe, J. (2008). Operational experience with indirect potable reuse at the Flemish Coast. *Desalination* 218(1), 198-207.
- Wintgens, T., Salehi, F., Hochstrat, R., & Melin, T. (2008). Emerging contaminants and treatment options in water recycling for indirect potable use. *Water Science and Technology* 57(1), 99-108. doi:10.2166/wst.2008.799
- WaterReuse Research Foundation (WRRF) (2007). *Reclaimed Water Aquifer Storage and Recovery: Potential Changes in Water Quality*. WRF-03-009-01. Alexandria, VA (USA): WaterReuse Foundation.
- Ziegler, D. H. (2001). *Untersuchungen zur nachhaltigen Wirkung der Uferfiltration im Wasserkreislauf Berlins*. Genehmigte Dissertation. Technische Universität Berlin.