

# REPORT

Contract : LIFE03ENV/D/000025

Cicerostr. 24  
D-10709 Berlin  
Germany  
Tel +49 (0)30 536 53 800  
Fax +49 (0)30 536 53 888  
www.kompetenz-wasser.de

## Sanitation Concepts for Separate Treatment of Urine, Faeces and Greywater (SCST) – Results Project acronym: SCST

by

Anton Peter-Fröhlich (Berliner Wasserbetriebe)  
Alexandre Bonhomme (Berlin Centre of Competence for Water)  
Martin Oldenburg (Otterwasser GmbH)

Contributors for membrane bio-reactor issues:  
Regina Gnirß (Berliner Wasserbetriebe)  
Boris Lesjean (Berlin Centre of Competence for Water)

for

Kompetenzzentrum Wasser Berlin gGmbH

Preparation of this report was financed in part through funds provided by Veolia Water  
and Berliner Wasserbetriebe



Berlin, Germany

2007

## **Important Legal Notice**

**Disclaimer:** The information in this publication was considered technically sound by the consensus of persons engaged in the development and approval of the document at the time it was developed. KWB disclaims liability to the full extent for any personal injury, property, or other damages of any nature whatsoever, whether special, indirect, consequential, or compensatory, directly or indirectly resulting from the publication, use of application, or reliance on this document.

KWB disclaims and makes no guaranty or warranty, expressed or implied, as to the accuracy or completeness of any information published herein. It is expressly pointed out that the information and results given in this publication may be out of date due to subsequent modifications. In addition, KWB disclaims and makes no warranty that the information in this document will fulfill any of your particular purposes or needs.

The disclaimer on hand neither seeks to restrict nor to exclude KWB's liability against all relevant national statutory provisions.

---

## **Wichtiger rechtlicher Hinweis**

**Haftungsausschluss** Die in dieser Publikation bereitgestellte Information wurde zum Zeitpunkt der Erstellung im Konsens mit den bei Entwicklung und Anfertigung des Dokumentes beteiligten Personen als technisch einwandfrei befunden. KWB schließt vollumfänglich die Haftung für jegliche Personen-, Sach- oder sonstige Schäden aus, ungeachtet ob diese speziell, indirekt, nachfolgend oder kompensatorisch, mittelbar oder unmittelbar sind oder direkt oder indirekt von dieser Publikation, einer Anwendung oder dem Vertrauen in dieses Dokument herrühren.

KWB übernimmt keine Garantie und macht keine Zusicherungen ausdrücklicher oder stillschweigender Art bezüglich der Richtigkeit oder Vollständigkeit jeglicher Information hierin. Es wird ausdrücklich darauf hingewiesen, dass die in der Publikation gegebenen Informationen und Ergebnisse aufgrund nachfolgender Änderungen nicht mehr aktuell sein können. Weiterhin lehnt KWB die Haftung ab und übernimmt keine Garantie, dass die in diesem Dokument enthaltenen Informationen der Erfüllung Ihrer besonderen Zwecke oder Ansprüche dienlich sind.

Mit der vorliegenden Haftungsausschlussklausel wird weder bezweckt, die Haftung der KWB entgegen den einschlägigen nationalen Rechtsvorschriften einzuschränken noch sie in Fällen auszuschließen, in denen ein Ausschluss nach diesen Rechtsvorschriften nicht möglich ist.

## **Abstract (English)**

### **>SCST<**

Duration: 1/2003 to 12/2006

Volume: 2,22 Mio €

Contractors: TUHH, TUB, HUB

Contact at KWB: Anton Peter-Fröhlich (Berliner Wasserbetriebe)

## EU-Demonstration project

# Sanitation Concepts for Separate Treatment of Urine, Faeces and Greywater (SCST) – Results

Duration of the project  
1 January 2003 to 31 December 2006

written by

*Anton Peter-Fröhlich* (Berliner Wasserbetriebe)  
*Alexandre Bonhomme* (Berlin Centre of Competence for Water)  
*Martin Oldenburg* (Otterwasser GmbH)

Contributors for membrane bio-reactor issues:

*Regina Gnirß* (Berliner Wasserbetriebe)  
*Boris Lesjean* (Berlin Centre of Competence for Water)

May 2007

This demonstration project is being co-financed in the framework of the LIFE programme of the European Commission (LIFE03 ENV/D/000025)



<b>1 INTRODUCTION.....</b>	<b>4</b>
<b>2 MATERIALS AND METHODS.....</b>	<b>4</b>
2.1 GENERAL CONCEPTS .....	4
2.2 VARIANTS .....	6
2.3 TESTED VARIANTS .....	6
2.4 FACILITIES .....	12
2.4.1 Toilets and urinals .....	12
2.4.2 Pipes.....	14
2.4.3 Vacuum plant .....	15
2.4.4 Urine Tanks.....	15
2.4.5 Membrane bio-reactor .....	16
2.4.6 Faeces separator.....	18
2.4.7 Compost technique.....	20
2.4.8 Soil filter .....	20
2.4.9 Septic tank.....	21
2.4.10 Constructed wetland .....	22
2.4.11 Biogas plant .....	25
2.5 VOLUME MEASUREMENT, SAMPLING AND ANALYTIC .....	27
2.5.1 Volume measurement .....	27
2.5.2 Sampling .....	28
2.5.3 Analysis.....	29
<b>3 RESULTS AND DISCUSSION .....</b>	<b>30</b>
3.1 TOILETS AND URINALS .....	30
3.1.1 Gravity separation toilet .....	30
3.1.2 Vacuum separation toilet .....	31
3.1.3 Waterless urinals .....	32
3.1.4 User survey .....	33
3.1.4.1 Office building .....	33
3.1.4.1.1 Questionnaire .....	33
3.1.4.1.2 Users of urinals and toilets and general results .....	35
3.1.4.1.3 Waterless urinal assessment .....	38
3.1.4.1.4 Gravity separation toilet assessment .....	39
3.1.4.1.5 Vacuum separation toilet assessment .....	39
3.1.4.1.6 Application potential for separation toilets and waterless urinals .....	40
3.1.4.1.7 Conclusion (user survey in the office building) .....	41
3.1.4.2 Apartment house .....	41
3.1.4.2.1 Questionnaire .....	41
3.1.4.2.2 Users of the toilets and general results .....	42
3.1.4.2.3 Gravity separation toilets .....	43
3.1.4.2.4 Conclusion (user survey in the apartment house).....	44
3.2 PIPES .....	44
3.3 VACUUM PLANT .....	45
3.4 COLLECTED URINE.....	46
3.5 TREATMENT FACILITIES.....	50
3.5.1 General .....	50
3.5.2 Faeces separator.....	50
3.5.3 Compost technique.....	52
3.5.4 Soil filter .....	53
3.5.5 Septic tank.....	55
3.5.6 Constructed wetland .....	58
3.5.7 Membrane bio-reactor .....	65
3.5.7.1 Operating conditions .....	65
3.5.7.2 Greywater characterisation and comparison with literature values .....	66
3.5.7.3 Operational issues .....	66
3.5.7.4 Sludge production .....	67
3.5.7.5 Carbon and nitrogen recovery .....	68
3.5.7.6 COD elimination.....	68
3.5.7.6 Nitrogen elimination .....	69
3.5.7.7 Phosphorus elimination.....	70
3.5.7.8 Disinfection.....	71
3.5.7.9 Filtration performance.....	71

3.5.7.9 Comparison of MBR and constructed wetland processes .....	71
3.5.7.10 Comparison of MBR and artificial wetland treatment performances .....	72
3.5.7.11 Conclusions for MBR issues.....	73
3.5.8 <i>Biogas plant</i> .....	73
3.6 ASSESSMENT OF SOURCE SEPARATION .....	75
3.6.1 <i>General</i> .....	75
3.6.2 <i>Office building</i> .....	76
3.6.3 <i>Apartment house</i> .....	78
3.6.4 <i>Comparing the office building with the apartment house</i> .....	79
3.6.5 <i>Plausibility of assessment of source separation</i> .....	82
<b>4 RESULTS OF CO-OPERATING INSTITUTIONS.....</b>	<b>83</b>
4.1 URINE TREATMENT.....	83
4.2 FERTILISER USAGE.....	83
4.3 LIFE-CYCLE-ASSESSMENT .....	83
4.4 COSTS.....	84
<b>5 SUMMARY AND CONCLUSIONS.....</b>	<b>85</b>
<b>ABBREVIATIONS .....</b>	<b>90</b>
<b>REFERENCES.....</b>	<b>91</b>

## 1 Introduction

In the SCST-Project (Sanitation Concepts for Separate Treatment of Urine, Faeces and Greywater), different sanitation concepts were demonstrated as alternatives to conventional sanitation systems. The project was realised in the facilities of the WWTP Stahnsdorf. In the demonstrated new sanitation concepts, gravity as well as vacuum separation toilets and waterless urinals were used. The different flows, separated at their source, were treated according to their composition and volume and then fed back into the water and nutrient cycle to the extent possible. For a better understanding, the different flows are very briefly described in **Tab. 1.1**:

**Tab. 1.1:** Description of the different volumes

	description	source	volume	organic load (BOD, COD)	nutrients (N, P, K)
greywater	wastewater without faeces and urine	shower washing basins	+	o	-
brownwater	faeces with flushing water	separation toilets	-	+	o
yellowwater	urine	separation toilets and waterless urinals	-	-	+

explanation: + much                      o medium                      - little

The main goal of this project was to develop new sustainable sanitation concepts which have significant advantages in relation to ecological as well as to economical aspects compared to the conventional systems (end-of-pipe-system). Further goals were to yield experiences on design, installation and operation. Of great interest were also the functionality and reliability of the demonstration plant, the cleaning efficiency of the connected treatment units and the user acceptance.

This project was supported by the European Union (LIFE03 ENV/D/000025).

## 2 Materials and Methods

### 2.1 General Concepts

The new sanitation concepts were realised in existing buildings (office building and apartment house) on the premises of the Stahnsdorf WWTP (**Fig. 2.1.1**) which is owned and operated by the Berliner Wasserbetriebe. The general process scheme used in the EU-proposal can be seen in **Fig. 2.1.2**.

The main sanitation facilities in the office building were gravity separation toilets (Roediger, 2001) and waterless urinals from different suppliers. The faeces and flushing water (brownwater) were discharged by gravity and drained into a compost separator (in the following referred to as faeces separator). Afterwards, the faeces were treated by composting. The filtrate from the faeces separator flowed through a soil filter and was mixed up with the presettled greywater. Greywater was settled in a septic tank before being treated in a constructed wetland. In parallel with the constructed wetland, a membrane bioreactor was being tested for greywater treatment. Urine flowed into storage tanks. Before using the urine as fertiliser, different methods were tested for handling and treating it, namely, storage, vacuum evaporation, steam stripping, precipitation, ozonisation, UV-irradiation, and different combinations of these processes.

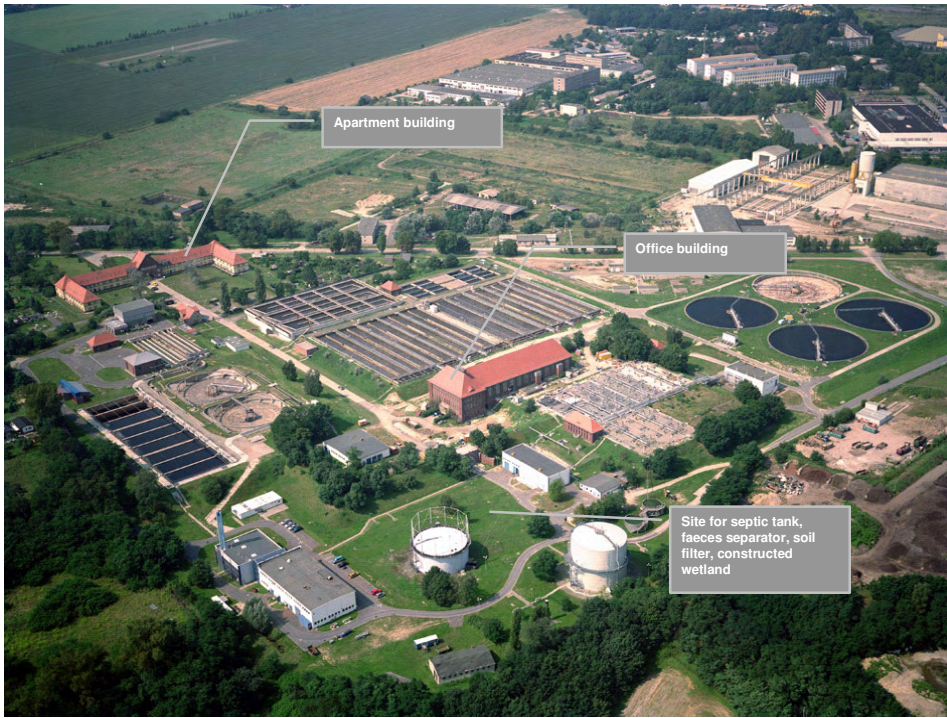

Fig. 2.1.1: Aerial view of WWTP Stahnsdorf and SCST-project site

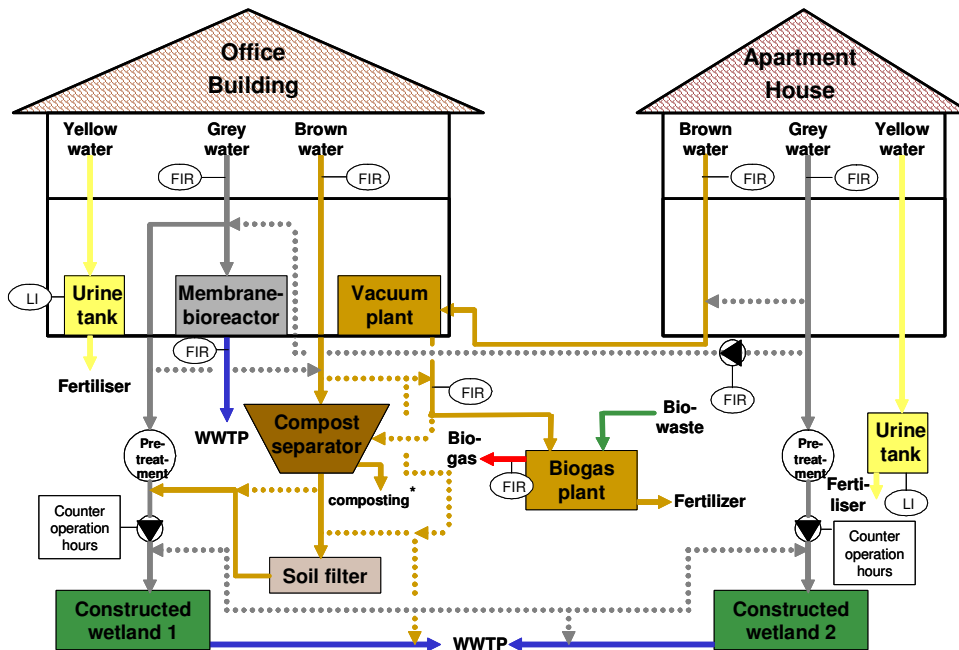

Fig. 2.1.2: New sanitation concepts with *gravity* separation toilets in the office building and *vacuum* separation toilets in the apartment house of the WWTP Stahnsdorf

Regarding the new sanitation concept for the apartment house, initially, vacuum separation toilets were taken into consideration. With these toilets, urine and greywater are discharged and transported by gravity, while faeces are transported by a vacuum sewer system. Urine is treated as described above. Due to the low dilution, faeces are digested together with bio-waste. In general, digested sludge is also a fertiliser, e.g. for farmlands. Biogas can be used either in gas cookers or in a combined heat and power unit (CHPU). These issues were not tested in this project. Like in the case of the office building, greywater passes through a sedimentation tank before its treatment in a constructed wetland. Since dish washing powders have a high content of phosphate (often more than 30 %), and dishwashing machines are more and more common, for both concepts a phosphate precipitation could



also be necessary during greywater treatment. After this treatment, greywater can be used e.g. for irrigation.

These two sanitation concepts are technical options within the new approach. Other options are possible, such as e.g. composting of the faeces together with bio-waste if a production of biogas is not wanted. Similarly, the type of greywater treatment has to be adapted to local conditions. For large settlements, an activated sludge tank or a technical bio-film system etc. could be a more appropriate solution than a constructed wetland. The size of an activated sludge tank for greywater treatment, however, could be much smaller than for municipal wastewater treatment due to the much lower COD, nitrogen and suspended solids loads (Otterpohl 2001).

As mentioned above, initially, vacuum separation toilets were considered for the apartment house in which only 10 flats instead of 15 were integrated into the new sanitation concept. But, since vacuum separation toilets were not available on the market at that time, the concept was changed: instead, the gravity separation toilets were used. Until then only vacuum separation toilets were available from the Roediger company which are modified gravity separation toilets. At that time, these toilets were prototypes just to demonstrate technical feasibility. Due to this fact, the concept was changed: the vacuum separation toilets were installed in the office building whereas the flats in the apartment house were equipped with the gravity separation toilets. For the office building, this was possible since a vacuum system was installed in addition to the gravity system. Thus, in order to change the concept, gravity separation toilets had to be replaced with vacuum separation toilets. For the operation of these two sanitation concepts different variants were planned to be included, requiring additional pipes (see **Fig. 2.1.2**).

## 2.2 Variants

The variants (V), including the main research questions chosen in the EU-proposal, were the following:

*V1 (with soil filter):* effectiveness of source separation (nutrient in urine); composition of the different flows (effectiveness of source separation); effectiveness of faeces separator (quality of raw material for composting); quality of compost; effectiveness of pathogens reduction of soil filter; effectiveness of greywater treatment in constructed wetland;

*V2 (without soil filter):* effectiveness of constructed wetland compared to V1 (remark: the words "soil filter" in front of "compared to V1" as written in the EU-proposal had to be deleted since it does not make any sense);

*V3 (grey and brownwater mixture and with soil filter):* common treatment of the mixture greywater and brownwater in faeces separator/soil filter;

*V4 (grey and brownwater mixture and without soil filter):* effectiveness of constructed wetland compared to V2;

*V5 (with membrane biology):* effectiveness of greywater treatment in membrane biology with the purpose of water reuse;

*V6 (with digester):* effectiveness of the digestion of brownwater collected and transported by vacuum in a digester together with bio waste; digester performance: organic matter reduction, gas production, pathogen reduction, impact of bio waste reduction; quality of liquid fertiliser; operation experience with vacuum transport systems;

*V7 (membrane biology with greywater from apartments):* effectiveness of digestion like V6; effectiveness of treatment of greywater from the apartments in the membrane biology;

*V8 (faeces from office building via vacuum and composting):* impact of vacuum collection and transport of brownwater on the process in the faeces separator;

## 2.3 Tested variants

A general timetable of the different operation conditions is given in **Fig. 2.3.2**. Details are described below.

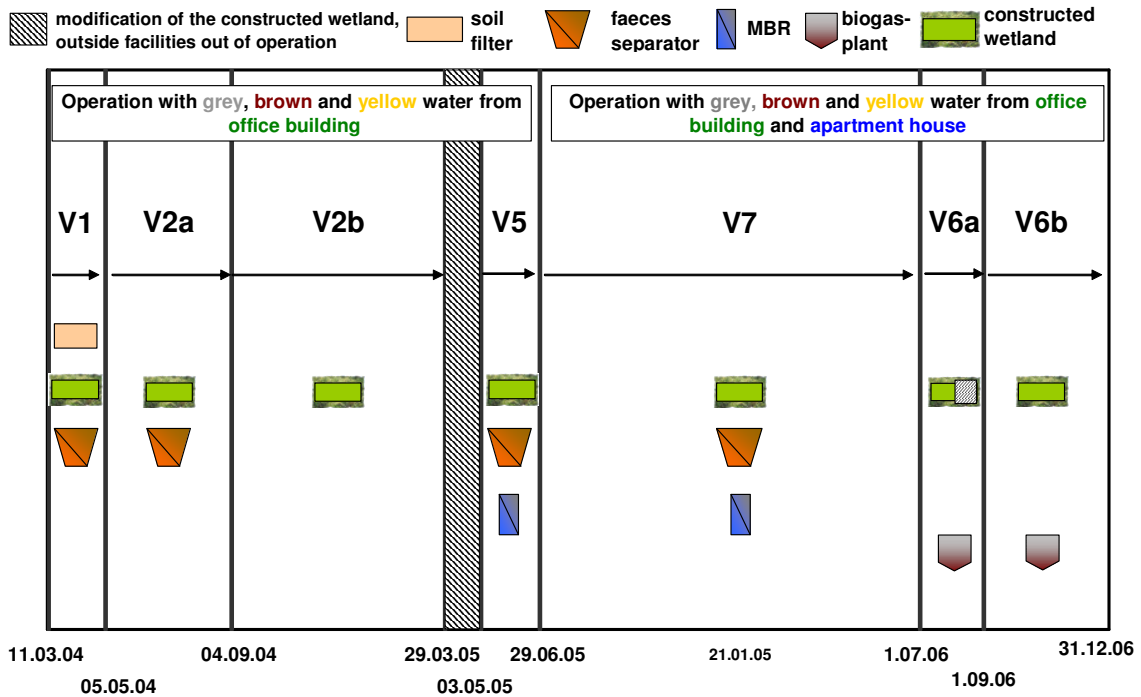
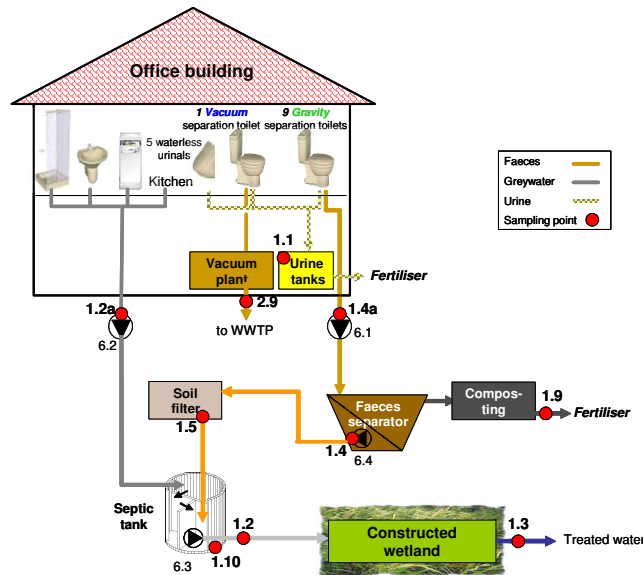

**Fig. 2.3.2:** Tested variants (V)

The operation of nine gravity separation toilets and one vacuum separation toilet started in October and December 2003. The operation of the treatment started in March 2004 with the first variant:

**Variant V1.**

The flow scheme of this variant is shown in **Fig. 2.3.3**.



**Fig. 2.3.3:** Flow scheme of *Variant V1* (with soil filter)

This variant was operated from 11 March until 4 May 2004.

The greywater from showers, wash basins, as well as the kitchen, including dish washers, and from the laboratory of the Stahnsdorf WWTP, was discharged by gravity into a pit outside the office building. From this pit, it was pumped into the first chamber of the two-chamber septic tank (see 2.4.9) by means of a cutting pump (6.2). The pre-settled greywater was pumped (6.3) to the constructed wetland (see 2.4.10). The biologically treated greywater flew into an effluent pit and, finally, into the influ-

ent of the Stahnsdorf WWTP, since no permission for discharging into the receiving water had been obtained.

The urine from nine gravity separation toilets, one vacuum separation toilet, and the five waterless urinals flowed by gravity into the urine tanks (see 2.4.4), where it was stored without pH-adjusting.

The brownwater from the vacuum separation toilet was sucked by a vacuum plant (see 2.4.3) which had been installed in the cellar rooms of the office building. From this vacuum plant, the brownwater was pumped into the WWTP. It has to be mentioned here that this first vacuum separation toilet, which is an altered gravity separation toilet (see 2.4.1), was installed in December 2003 for testing purposes only.

The brownwater, including flush water from the nine gravity separation toilets as well as the flush water from flushing the toilet bowls after urinating, was discharged by gravity into the pit in front of the office building. From this pit, by means of a cutting pump (6.1), the brownwater was pumped into the faeces separator (see 2.4.6) for dewatering and storage. The filtrate was pumped to the soil filter (see 2.4.8) in order to remove particles and pathogenic germs before it flowed by gravity to the pump chamber of the septic tank, where it was mixed up with the pre-settled greywater.

The main research questions for this variant are mentioned in the description of V1 in chapter 2.2.

Because of the high concentration of suspended solids (SS approx. 300 mg/l) in the brownwater, the operation of the soil filter became very difficult. After a few weeks, on 4 May 2004, it was blocked and taken out of operation. On that day, the *Variant V2* was started. This variant had to be divided into sub-variants V2a and V2b which were not mentioned in the EU-Proposal because the equipments were installed at different times.

### Variant V2a

The flow scheme of this variant is shown in **Fig. 2.3.4**.

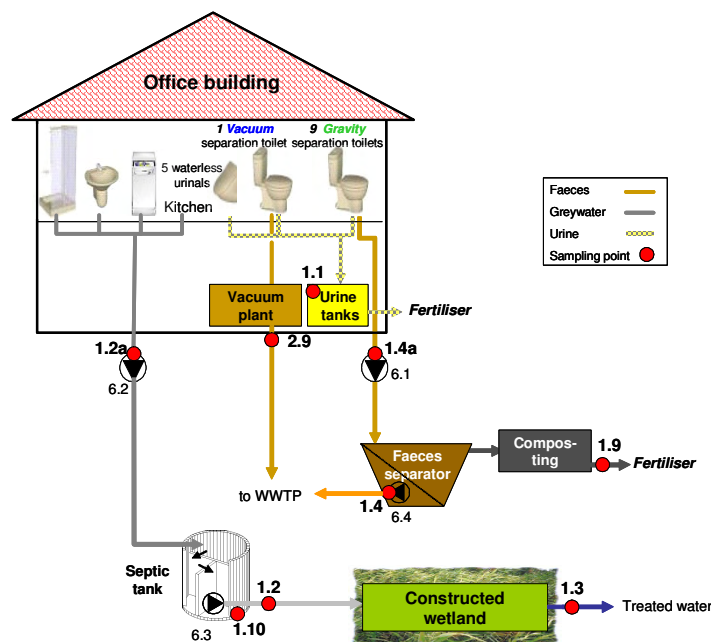

**Fig. 2.3.4:** Flow scheme of *Variant V2a* (without soil filter and no treatment of faecal filtrate)

This variant was operated from 5 May 2004 until 3 September 2004. The difference to *Variant V1* consisted in the missing treatment of the filtrate of the faeces separator by the shutdown of the soil filter. Instead, the filtrate was discharged by gravity into the Stahnsdorf WWTP.

The main research focus for this variant was to compare the effectiveness of the constructed wetland with its effectiveness during *Variant V1*. After the test of *Variant V2a* the

**Variant V2b,**

shown in Fig. 2.3.5, was started.

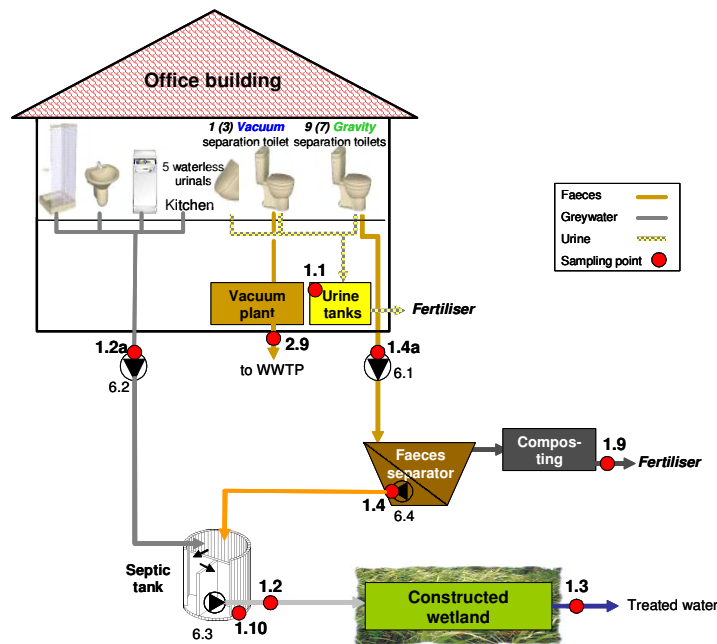

**Fig. 2.3.5:** Flow scheme of *Variant V2b* (without soil filter, but treatment of faecal filtrate)

This variant was run from 4 September 2004 until 29 March 2005. The main research focus of this variant was to test the efficiency of the constructed wetland for pre-treated greywater including faeces filtrate. The pre-treatment of the faeces filtrate changed from filtration (*Variant V1*) to the removal of suspended solids by sedimentation in the first chamber of the septic tank.

In contrast to *Variant V2a*, from 15 September onwards the faeces filtrate was pumped instead of being discharged by gravity. For this operation mode, the change of the pipes of pump 6.4 was necessary. The main reason for using the pump was to receive a proper mixture of the faeces filtrate in the suction well where samples were taken by an automatic sampler. The mixture was created by switching the pump on and off, depending on the filtrate level in the suction well.

During the operation of this variant, in December 2004, two more gravity separation toilets were replaced with vacuum separation toilets. From then until the end of operation of this variant (March 2005), the faeces from only seven gravity separation toilets could be collected in the faeces separator. Thus, slightly less faeces filtrate was mixed up with the greywater.

The operation of this variant showed that the distribution on the surface of the constructed wetland could be optimized. From 30 March until 2 May 2005, the distribution system of the constructed wetland (see 2.4.10) was improved. Throughout this period, all outside facilities (constructed wetland, septic tank, faeces separator) were put out of operation. After these changes and the installation of the membrane bio-reactor, the operation of *Variant V5* started.

**Variant V5**

The *Variant V5* (Fig. 2.3.6.) was in operation from 3 Mai until 28 June 2005. This variant differed from *Variant V2b* mainly in that it involved the additional operation of the membrane bio-reactor, the operation of nine vacuum separation toilets, and the remaining gravity separation toilet. Since the gravity separation toilet was frequented less often, nearly no faecal filtrate was mixed up with the greywater. After some start-up works, the operation of the membrane bio-reactor started on 25 May 2005.

The main research focus of this variant was to get to a stable operation process with the addition of the membrane bio-reactor and to investigate the quality of the treated greywater exclusively from the office building.

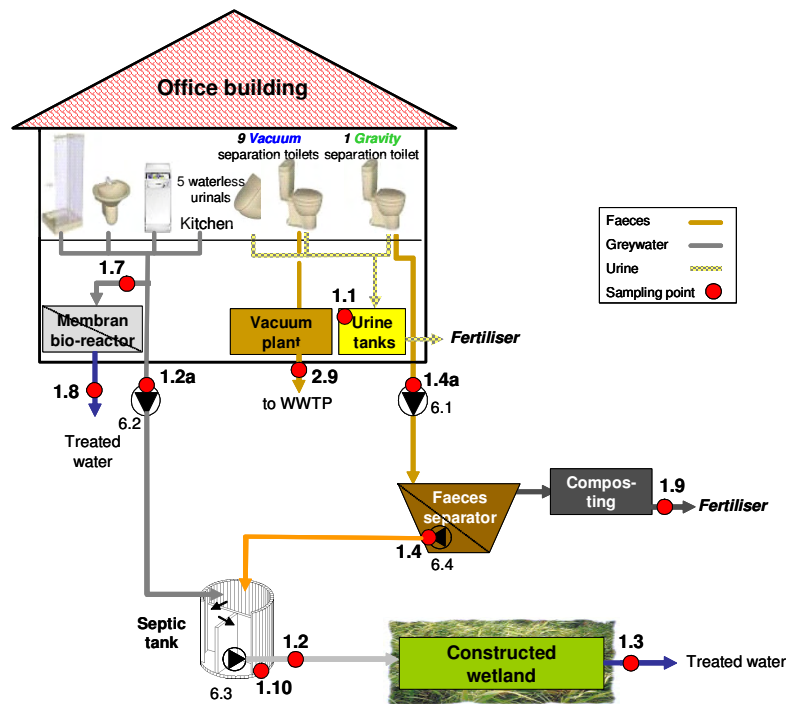

**Fig. 2.3.6:** Flow scheme of *Variant V5* (without soil filter, but treatment of faecal filtrate and operation of membrane bio-reactor)

From the end of June on it was possible to treat also greywater with the membrane bio-reactor from the apartment house since pipes and connections of the pumps for grey and brownwater had been finished (pumps for yellowwater had not yet been installed). That means

#### ***Variant V7,***

which is shown in **Fig. 2.3.7**, could be started on 29 June 2005 and was operated until 30 June 2006.

Additional gravity separation toilets were installed in ten flats of the apartment house; six in the left wing of the building and four in the right wing. The greywater from this part of the house was discharged into pits outside of the apartment house by gravity, similar to the process for the office building described for *Variant V1*. From these pits, it was pumped into the office building with cutting pumps (B1 and B2) and mixed up with the greywater from this building. Then, the greywater was pumped in the same manner as in *Variant 1*. After mixing both greywater flows, the greywater for the membrane bio-reactor was retained from the greywater pipe.

The brownwater also flowed into pits outside apartment house by gravity. From these pits, it was pumped directly to the faeces separator with cutting pumps (A1 and A2) in order to dewater and collect the faeces. The filtrate was pumped (6.4) into the first chamber of the septic tank.

Like the brownwater, the urine flowed into pits outside of the apartment house by gravity, and, from there, to the WWTP. From October 2005 on, it was pumped into the urine storage tanks in the office building.

In this *Variant V7*, changes were made to the *Variant V7* described in the EU-proposal (see 2.2). First, the *Variant 7* was run without the digester for faeces and bio-waste treatment, and, second, the greywater was a mixture discharged from both, the office building as well as the apartment house. The results of the operation of the membrane bio-reactor were equally reliable when greywater from the office building was mixed with the greywater from the apartment house. The main volume of greywater came from the apartment house.

The main research focus of *Variant V7* was to test the effectiveness and quality of the mixture of both greywater flows.

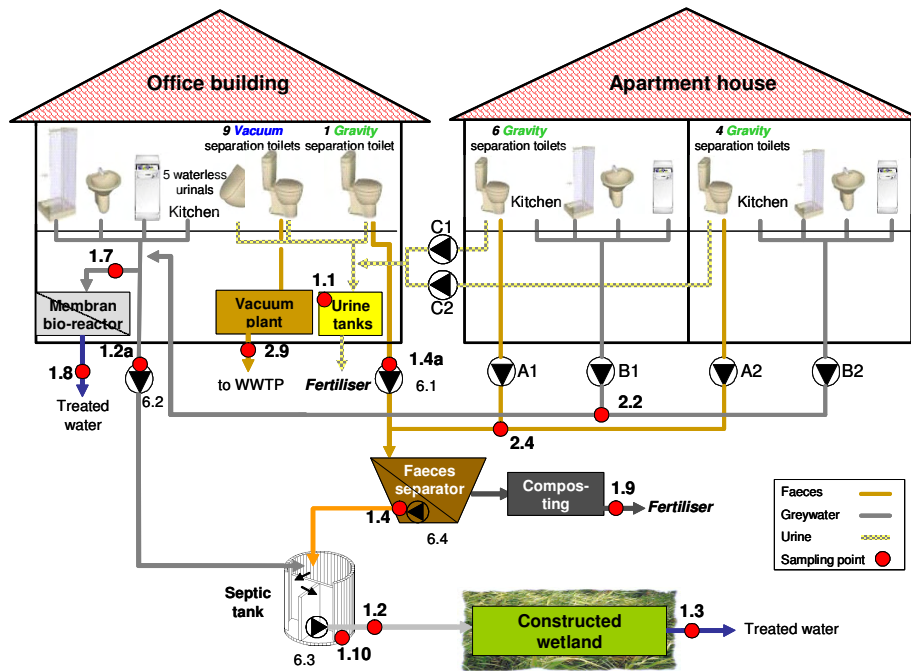

**Fig. 2.3.7:** Flow scheme of *Variant V7* (without soil filter, but treatment of faecal filtrate, operation of membrane bio-reactor including greywater from apartment house)

**Variant V6a**

During *Variant 6a*, the biogas plant could be tested for the first time (**Fig. 2.3.8**). It was operating from 1 July until 31 August 2006.

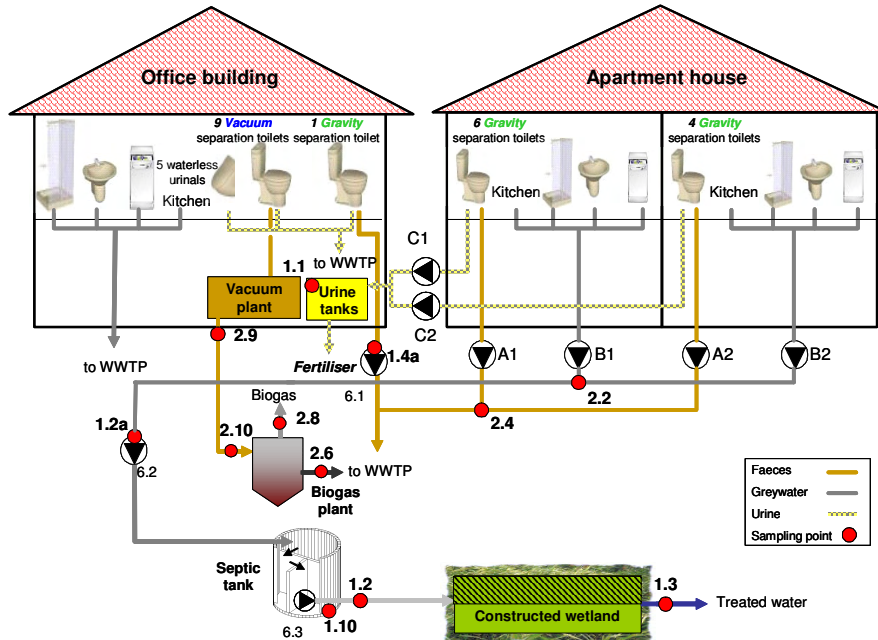
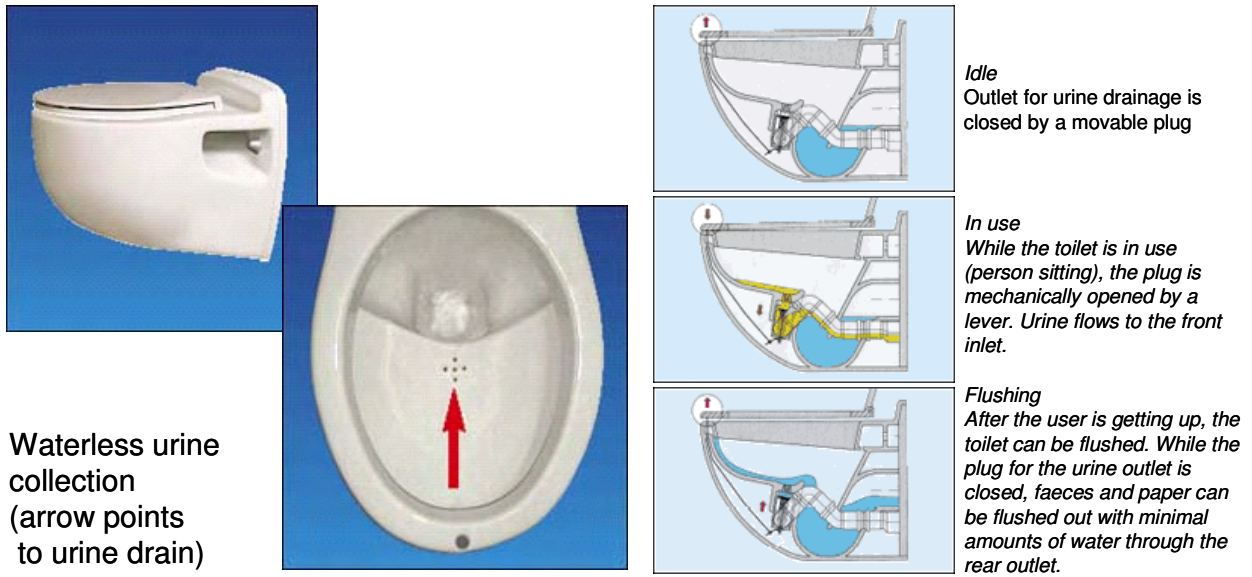

**Fig. 2.3.8:** Flow scheme of *Variant V6a* (with biogas plant, operation of the half-constructed wetland, no treatment of faecal filtrate)

During this period, only the half-constructed wetland was operated - with greywater exclusively from the apartment house. This was a measure taken in order to reactivate the treatment efficiency after the constructed wetland had gotten clogged at the end of *Variant 7*.

The biogas plant was operated with the brownwater from the vacuum plant.





**Fig. 2.4.1:** Gravity separation toilet (Roediger-No Mix Toilet; Roediger 2001)

*Vacuum separation toilets*

Until this day, a vacuum separation toilet is not available on the market. Therefore, the Roediger company prepared a prototype for the use in vacuum systems by modifying the gravity No Mix-Toilet. (**Fig. 2.4.2**).



**Fig. 2.4.2:** Vacuum separation toilet



In general, the function of this toilet is similar to the gravity separation toilets. Only the faeces outlet is connected to the vacuum system and the faeces, including flushing water, are sucked off. The vacuum equipment is the same as for the Roediger vacuum toilets (Roediger 2001). The amount of flushing water is always the same, for flushing the faeces and for flushing the urine area because the same flushing system is used for both. The amount of flushing water can be adjusted up to about 3 L/flush. In the office building, different flushing volumes were chosen for the different toilets:

- Seven toilets adjusted to 1 L/flush,
- One to 0.7 L/flush (women dressing room, first floor) and
- One to 1.5 L/flush (women's toilet, second floor).

Since the quantity of flushing water was low, a flushing water tube made of polyethylene with a diameter of 8 mm was installed beneath the ceramic edge inside of the toilet bowl. This tube had small wholes in a distance of about 20 mm. It was not possible to flush toilet paper from front to the rear faeces effluent with this flushing system only. This situation improved slightly when additional wholes were inserted in front of the flushing tube, but it was still not satisfying. Here, further improvement (in product development) by the producer is necessary.

In order to reduce the flushing noise and save energy for vacuum production, interim brownwater storage tanks with a volume of approx. 8 L each were installed near the toilets. At most two toilets were connected to one of these tanks, which were always emptied automatically when being filled. Thus, a water flush of approx. 8 L at once could be transported in the vacuum pipes.

#### *Waterless urinals*

Five waterless urinals from different companies were operated in the office building: two from the Urimat company (Urimat, 2005), two from the Ernst company (Ernst 2005), and one from the Duravit company (Duravit 2005) (**Fig. 2.4.3**).



**Fig. 2.4.3:** Waterless urinals

In order to prevent odour caused by the pipe system, different systems of siphons were used. Ernst and Urimat urinals were equipped with a removable siphon. Urinals from Ernst as well as from Duravit used sealing liquids which were floating on the urine due to lower density, covering the surface. The Urimat urinals used a physical system (membrane, float, electromagnet) for the seal.

Since users complained about bad smell mainly coming from the Urimat urinals, they were exchanged with Keramag Centaurus urinals (Keramag 2007).

#### **2.4.2 Pipes**

The used pipes for grey, brown and yellowwater are listed in **Tab. 2.4.1**.

**Tab. 2.4.1:** Pipes for grey, brown and yellowwater

			greywater	brownwater	brownwater	yellowwater
				gravity separation toilets	vacuum separation toilets	
material		inside buildings	SML-pipe (cast iron)	SML-pipe (cast iron)	PE-HD-pipe (polyethylene)	HAT-pipe/PPs (polypropylene)
material		pressure lines outside buildings	PE-HD-pipe (polyethylene)	PE-HD-pipe (polyethylene)		PE-HD-pipe (polyethylene)
nominal internal diameter	mm	inside buildings	50 to 150, mainly 100	100 to 150, mainly 100	40 and 50, mainly 50	50 and 70, mainly 70
nominal internal diameter	mm	pressure lines outside buildings	50	50		40

The main pipes for yellowwater had a nominal internal diameter of 70 mm. Only the connection pipes to the toilets and urinals were built with a diameter of 50 mm. This decision was based on experiments in different projects in Scandinavia which had been visited during the pre-study of this project. In order to check if precipitant products accumulated in the yellowwater pipes, acrylic glass pipes with a length of 0.5 m each were installed horizontally inside the two yellowwater pipes just before they went into the urine tanks.

### 2.4.3 Vacuum plant

The vacuum plant (**Fig. 2.4.4**) used in this project was the smallest unit available from the Roediger company (Roediger 2001). It was installed in the cellar of the office building and was able to serve at least 40 toilets. The vacuum (0.6 bar) was produced by two redundant vacuum pumps which were installed on top of the unit. For the discharge of brownwater from the vacuum tank two redundant pressure pumps were installed behind the small storage tank of the unit.

**Fig. 2.4.4:** Vacuum plant

### 2.4.4 Urine Tanks

For urine storage, four tanks with double walls with a volume of 1,000 L each were installed in the cellar of the office building (**Fig. 2.4.5**). The outer tank was made of galvanised steel plate and the inner tank of polyethylene.



**Fig. 2.4.5:** Urine tanks

#### 2.4.5 Membrane bio-reactor

A membrane activated sludge (or membrane bioreactor, MBR) pilot unit (**Fig. 2.4.6**) was operated to treat real greywater collected from bathrooms and kitchens of the office building and the apartment house.



**Fig. 2.4.6:** Membrane bio-reactor

The membrane bio-reactor pilot plant (MBR) consists of a rectangular biological reactor with a working volume of 35 – 60 L. A flat sheet membrane module of 2.6 m<sup>2</sup> (polyphenol resin with 0.4 μm pore size) supplied by the company A3 water solutions (Gelsenkirchen, Germany), equipped with 2 perforated tubular aerators at the bottom of the reactor supplying air for both module scouring and the biology aeration at a constant rate of about 2.6 Nm<sup>3</sup>/h constitute the membrane bio-reactor module (**Fig. 2.4.7**). The flat sheet membranes had an orientation parallel to the filtration.

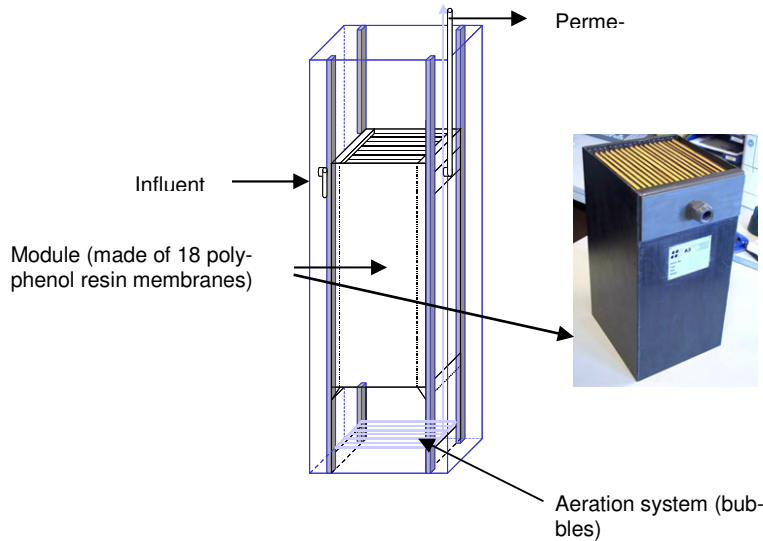

**Fig. 2.4.7:** Membrane bio-reactor module

The pilot unit (**Fig. 2.4.8**) consists of the following steps:

- an equalisation tank of up to 1 m<sup>3</sup>, equipped with a slow mixer, and gravity fed with mixed grey-water collected in the kitchen and bathrooms of the office building and the apartments;
- a centrifuge feed pump set up within a screen basket (1mm slit) at the bottom of the equalisation tank;
- a single biological reactor adjustable in the range 35-50 L;
- a membrane bio-reactor module (described above);
- a peristaltic pump to suck the permeate out of the membrane module; and
- an excess sludge pump and a sludge tank for regular extraction of the sludge and monitoring of the volume.

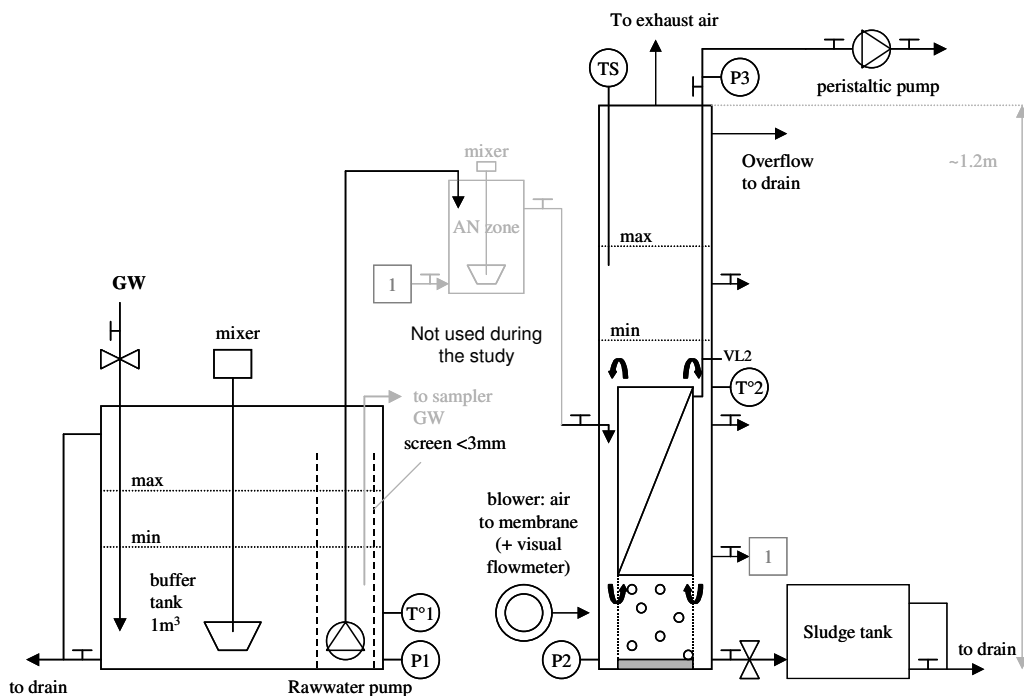

**Fig. 2.4.8:** Flow scheme of the membrane bio-reactor

The feed system was composed of an agitated buffer tank of 500 L and a peristaltic pump. The Hydraulic Retention Time (HRT) in this tank was adjustable between 6 and 24 hours. Raw greywater was passed through a filtration stage (screen basket) and then pumped straight to the bio-reactor. The permeate was removed using a peristaltic pump. This pump operated on an adjustable time basis (for

example 15 min ON / 5 min OFF) in order to minimise fouling on the membrane surface. The HRT (1 - 5 hours) in the reactor was adjusted by changing the permeate flow and the reactor volume. The solid retention time (SRT) in the MBR reactor was controlled by regular extraction of sludge with a pump set by a timer. The sludge was gathered in a tank. SRT in the bioreactor was adjusted by changing the pump flow manually. Two pressure transducers controlled the levels in the buffer tank and the reactor. A third was used to measure the relaxation (PR) and filtration (PF) pressures and to calculate the transmembrane pressure (TMP). The unit was also equipped with an on-line data acquisition system for temperature, dissolved oxygen and mixed liquor height (therefore volume) in the aerated reactor. The pH in the buffer tank and in the reactor was measured manually with a pH-meter. The standard buffer solutions of pH values 4 and 7 were used to calibrate the instrument. The anaerobic tank for pre-denitrification and biological phosphorus removal indicated on the flow scheme was not used during the study. The pilot plant was connected to a computer, which commanded pumps and levels in the tanks (analogical values). It recorded the parameters (numerical values) too: levels in reactor and buffer tank, flow of pumps, pressures, and biological parameters. They were recorded every 30 seconds during the week and every minute during the week-end. Two automatic refrigerated samplers, for grey water and permeate, completed the system for collection of 24h-mean samples.

#### 2.4.6 Faeces separator

The dewatering of faeces was done in filter bags (faeces separator), which are shown in **Fig. 2.4.9**.



**Fig. 2.4.9:** Fugafil-Saran Filter bag (PE 1200/500) for faeces dewatering

The filter bags were from the Fugafil-Saran GmbH company (Fugafil-Saran 2005). Two different types were used: first, until 10 May 2005, the polyethylene filter bag PE 1200/500 with a pore size of 1.2 mm; then, from 11 May 2005 on, the polypropylene filter bag PP 1500/500 FLH with a pore size of 1.4 mm. Both filter bags had a diameter of 600 mm and a height of 800 mm.

The filter bags were installed in a pit of concrete (Fig. 2.4.10)

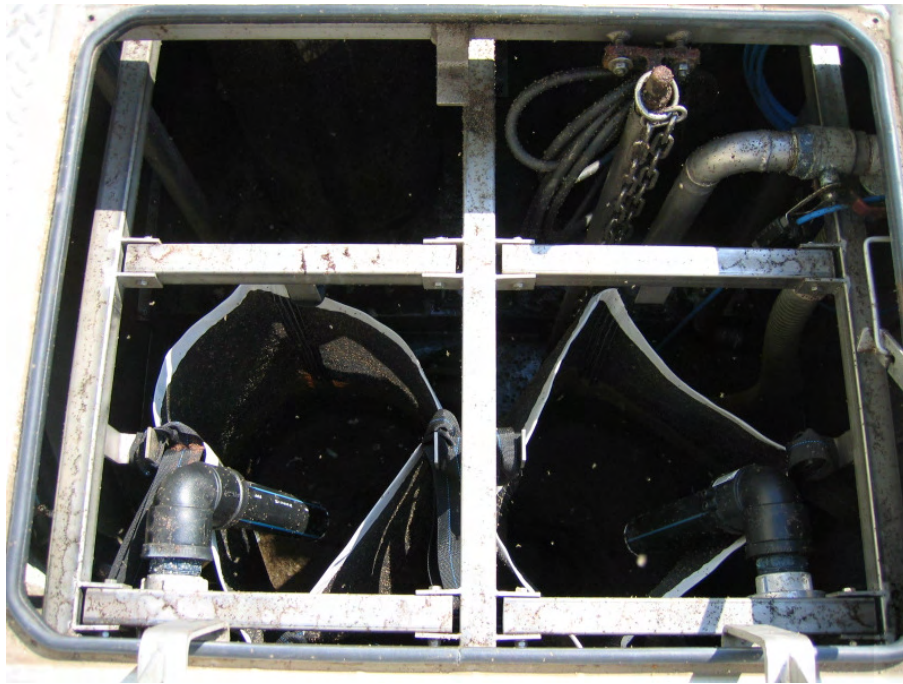

**Fig. 2.4.10:** Faeces dewatering facility

At first two filter bags were installed. But because of the higher volumes since the connection of the apartment house to the treatment facilities two more filter bags had to be installed.

By the start of the operation, about 10 litres of bark mulch were added to each empty filter bag. This improved the backing of faeces during start up of the filter bags. The filled filter bags could be removed with a crane (Fig. 2.4.11). The filtrate could be discharged into different directions with a pump as described above (see 2.3).



**Fig. 2.4.11:** Faeces dewatering facility including crane

### 2.4.7 Compost technique

For composting the thickened faeces collected from the office building the filled filter bags stayed in the faeces dewatering pit for post-self dewatering for one to two weeks. The filter-bags with the dewatered faeces were removed with the crane, put into waterproof bags, and then transported to the research camp of the Humboldt University in Berlin-Dahlem, where fertiliser experiments were undertaken (Task 8 of the project). To each of the first two bags, which were filled at the same time in March 2004, 1,000 worms *Eisenia fetida* from the company Regenwurmfarm Tacke GmbH (Tacke 2005) were added on 4 October 2004. Both bags were covered by a conventional compost hood (Fig. 2.4.12) and stored in a room tempered at about 20 °C.

A further collecting of faeces for composting took place from December 2005 to May 2006. These faeces originated from the toilets users of the apartment house. The thickened faeces were not composted from the Humboldt University Berlin as described above. The filter bags (four, each approx. 30 % filled) with the thickened faeces were putted in rain barrels which were not covered. The water could flow away through a bottom effluent. After adding 1,000 worms as described above the composting took place outside of a building.



Fig. 2.4.12: Faeces for composting in a compost hood

### 2.4.8 Soil filter

The soil filter (Fig. 2.4.13) was intended to be used for removing pathogen germs from the faecal filtrate before mixing it with pre-settled greywater in the pump chamber of the septic tank.

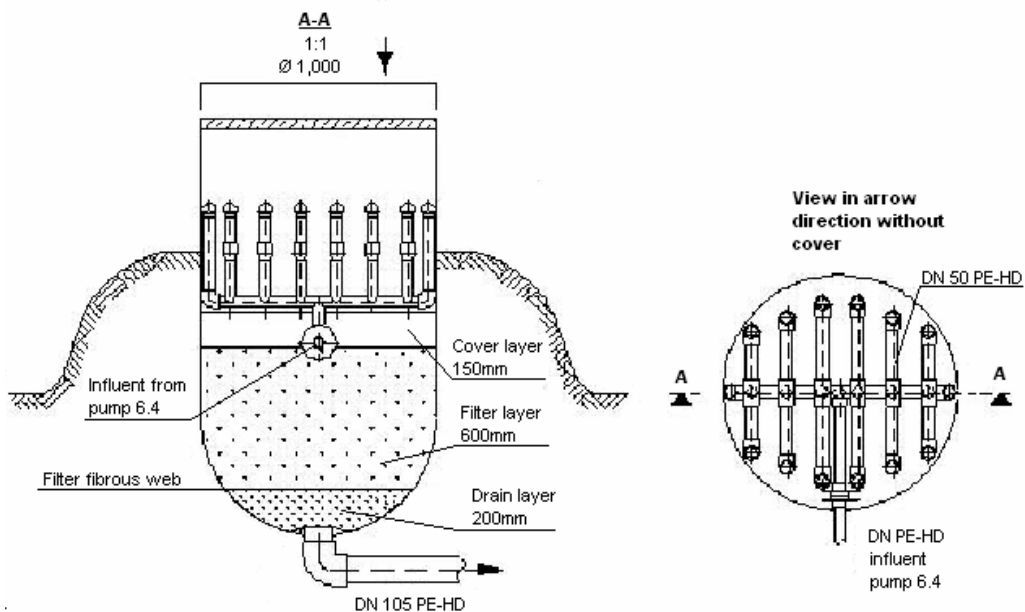

Fig. 2.4.13: Soil filter

Design data of the soil filter and the build up of the filter are given in **Tab. 2.4.2** and **Tab. 2.4.3**, respectively.

**Tab. 2.4.2:** Soil filter, design parameter

filter load	$q_A$	$m^3/(m^2 h)$	0.2
daily flow of faeces filtrate	$Q_d$	$m^3/d$	0.685
filter area selected	A	$m^2$	0.8

**Tab. 2.4.3:** Soil filter, filter layer

	heights (cm)	material	graining
cover layer	15	gravel	8/16
filter layer	60	sand	0/4
filter fibrous	-	-	-
drain layer	20	gravel	8/16
geo fibrous	-	-	-

The filter was designed for a filter load of  $0.2 m^3/(m^2.h)$  in order to realise a slow sand filtration process. The inlet distribution was made of pipes which were installed in the cover layer. These pipes had 10 mm wholes with a distance of 10 cm in between and were located on the bottom side. Since the filter was blocked after about five weeks of operation, the distribution system was removed from the filter layer and fixed about 10 cm above it. This, however, could not prevent the soil filter from blocking, which led to the stop of the operation on 4 May 2005 (see *Variant V1*, chapter 2.3).

In order to be able to take representative samples from the effluent of the soil filter with an automatic sampler, a control pit was installed.

### 2.4.9 Septic tank

The septic tank for greywater and faecal filtrate pre-treatment is shown in **Fig. 2.4.14** and design data are given in **Tab. 2.4.4**.

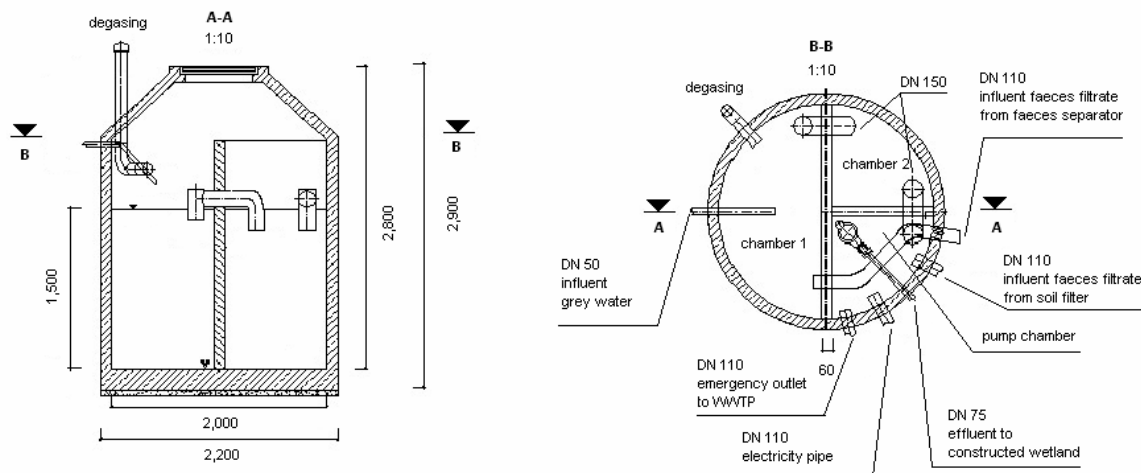

**Fig. 2.4.14:** Septic tank



**Tab. 2.4.4:** Septic tank, design data

inflow	$Q_{10}$	$m^3/h$	0.458
total working capacity chamber 1	$V_1$	$m^3$	2.27
total working capacity chamber 2	$V_2$	$m^3$	1.09
volume reduction for solids storage	-	%	50
retention time by 50 % volume reduction	t	h	3.7

The septic tank is a two chamber tank. Greywater and faeces filtrate were pumped into chamber 1 first, then flowed into chamber 2 via submersed overflows, then into the pump sump from where they were pumped into the constructed wetland. The delivery of the pumps was 4.91 L/s.

### 2.4.10 Constructed wetland

A general view of the constructed wetland is shown in **Fig. 2.4.15**.



**Fig. 2.4.15:** Constructed wetland

The type of this treatment plant was an intermittent loaded vertical flow constructed wetland. The design data and data of the different layers are given in **Tab. 2.4.5** and **Tab. 2.4.6**.

**Tab. 2.4.5:** Constructed wetland, design data

inflow	$Q_d$	$L/d$	4.580
max. inflow	$Q_{d,max}$	$L/d$	5.265
population equivalents	E	-	58
spec. inflow	$Q_{d,spec.}$	$L/(E d)$	80
spec. BOD-load	$B_{d,BOD}$	$g/(E d)$	30
spec. area	$A_{spec.}$	$m^2/E$	2
surface flow rate	$q_A$	$L/(m^2 d)$	40
area	A	$m^2$	116
length	L	m	14.5
width	B	m	8.0

**Tab. 2.4.6:** Constructed wetland, layer data (from top to bottom)

	description	layer height	material	graining
1	plants	5 plants/m <sup>2</sup>	reed	
2	upper layer	10 (20)* cm	gravel	0/16 (16/32)*
3	filter layer mixed up with waterwok iron sludge (2.2 m <sup>3</sup> )	80 (70)* cm	sand	0/4
4	geo textile			
5	drainige layer	15 cm	gravel	8/16
6	pond foil	0.015 cm	polyethylen	
7	geo textile			

\* since changing works in April 2005

The cross section of this constructed wetland is shown in **Fig. 2.4.16** and the distribution system in **Fig. 2.4.17**.

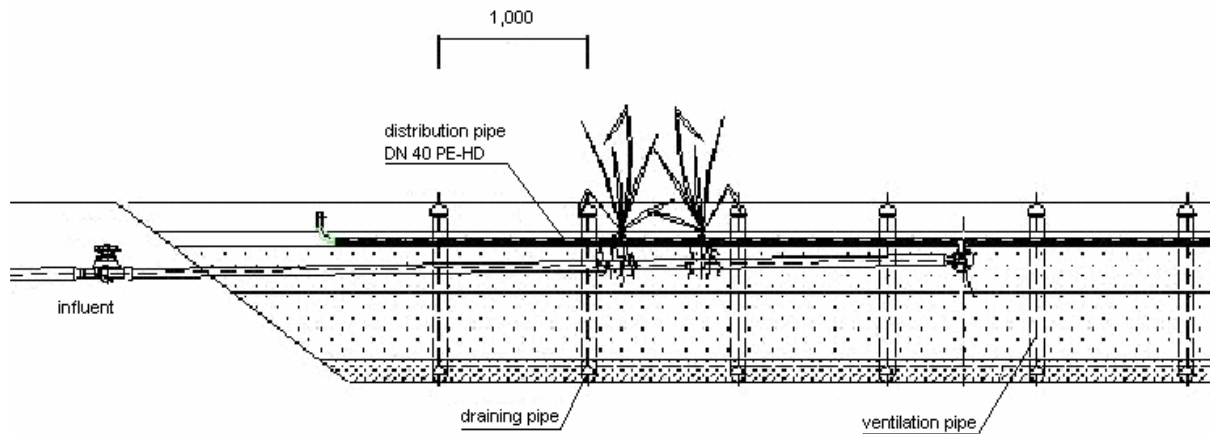

**Fig. 2.4.16:** Constructed wetland, cross section

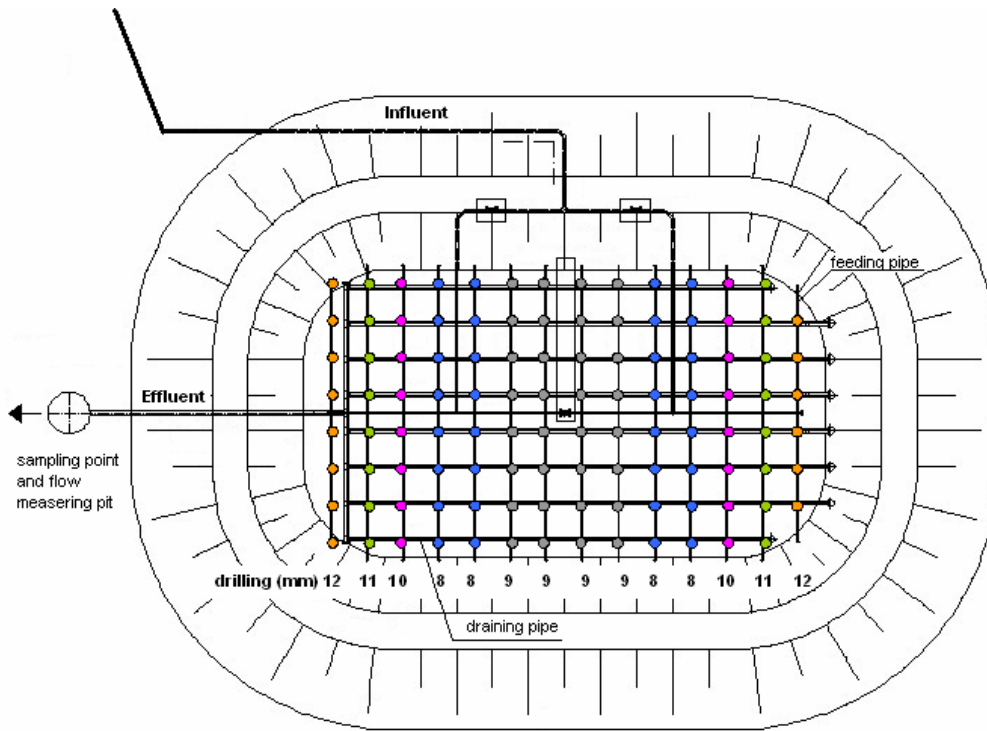

**Fig. 2.4.17:** Constructed wetland, distribution system

The pre-settled water from the septic tank was pumped through a pipe in intervals of 4.91 L/s (see 2.4.9). The pipe was divided into two inlet pipes at the top of the constructed wetland. Each of the two inlet pipes fed into the main feeding pipe, to which the distribution grid of fourteen distribution pipes was connected (**Fig. 2.4.16** and **Fig. 2.4.17**). On the bottom side, each of the distribution pipes was equipped with holes of different diameters (8 – 12 mm) in a distance of 1 m (**Fig. 2.4.17**). The treated water was discharged into the bottom of the wetland by eight drainage pipes which were connected to the central effluent pipe. After measuring the volume by tip water meter and sampling in the effluent pit, the treated water was discharged into the WWTP Stahnsdorf. Through the installation of two inlet pipes and the possibility to shut-off the pipes through valves, only half of the total area could be loaded with wastewater.

After one year of operation, it became obvious that the distribution of the influent was not satisfying because the reed plants had grown to different heights and densities. Instead of a top layer with a coarse diameter of 8/16 mm (height 10 cm), the upper layer was constructed with the small coarse of 0/4 mm. Thus, the roots of the plants had grown into the distribution system by entering the holes, therefore clogging the system. Consequently, the result of the inflow distribution was not satisfying. In order to optimise the process, reed and upper layer were removed in April 2005 and tests of influent distribution undertaken (**Fig. 2.4.18**).



**Fig. 2.4.18:** Constructed wetland, distribution system

Based on these tests, the 8 mm holes of the distribution pipes were extended to 9 mm, and the 10 mm holes to 11 mm. Furthermore, the upper layer was replaced by another gravel layer (16/32), and the distribution pipes were covered with a 5 cm deep layer of this gravel. After these changes, the constructed wetland was replanted with reed.

The growth of the reed plants became more regular. This was seen as a sign for a much better distribution of the water. The growth heights became very even for the entire area of the constructed wetland.

### 2.4.11 Biogas plant

For digestion of the brownwater from the vacuum separation toilets and bio-waste, a two-stage thermophile biogas plant, made by the company Hans Huber AG (Hans Huber 2007), was used (Fig. 2.4.19 and Fig. 2.4.20).

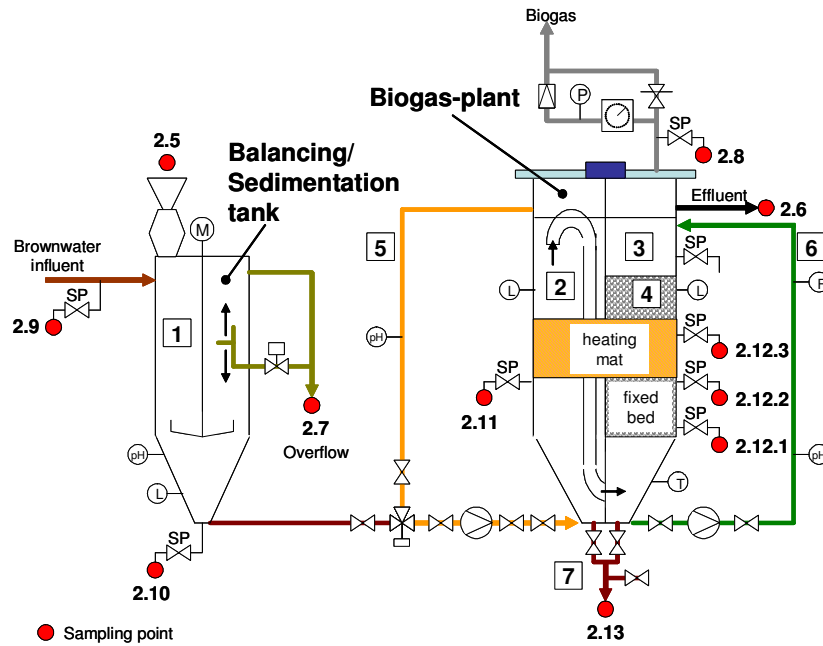

Fig. 2.4.19: Flow scheme of the thermophile two-stage biogas plant including sampling points



Fig. 2.4.20: Thermophile two-stage biogas plant

The biogas plant consisted of a balancing tank including stirrer (1) and the biogas-reactor itself. The first stage (2) of the biogas plant is the acidification reactor, and the second stage (3) the methanogenic reactor. In this reactor, a fixed bed made of polypropylene with a height of 600 mm and a channel size of 40 mm is installed (4) (**Fig. 2.4.21**). The sludge in the acidification stage could be mixed by means of an eccentric screw pump which sucked it from top and pumped it to the bottom into the reactor again (5). The mixture of the sludge in the methanogenic stage could be done with the same procedure, but in opposite direction (6). For the removal of surplus sludge effluent pipes with valves (7) are installed at the bottom of each stage. The biogas plant could be operated either in semi-automatic or full-automatic mode.



**Fig. 2.4.21:** Fixed bed (2H Kunststoff GmbH (2H Kunststoff 2007)) of the methanogenic stage of the thermopile two-stage biogas plant

For combined operation of brownwater and bio-waste from tenants of the apartment house, the bio-waste had to be grinded beforehand. This was done with a grinder from the company Edertal Elektromotoren GmbH & Co. KG (Edertal 2007).



**Fig. 2.4.22:** Grinder (Edertal 2007) for bio-waste for biogas plant

Near the biogas plant, in a protecting house, two 1,000 L tanks were installed (**Fig. 2.4.23**).

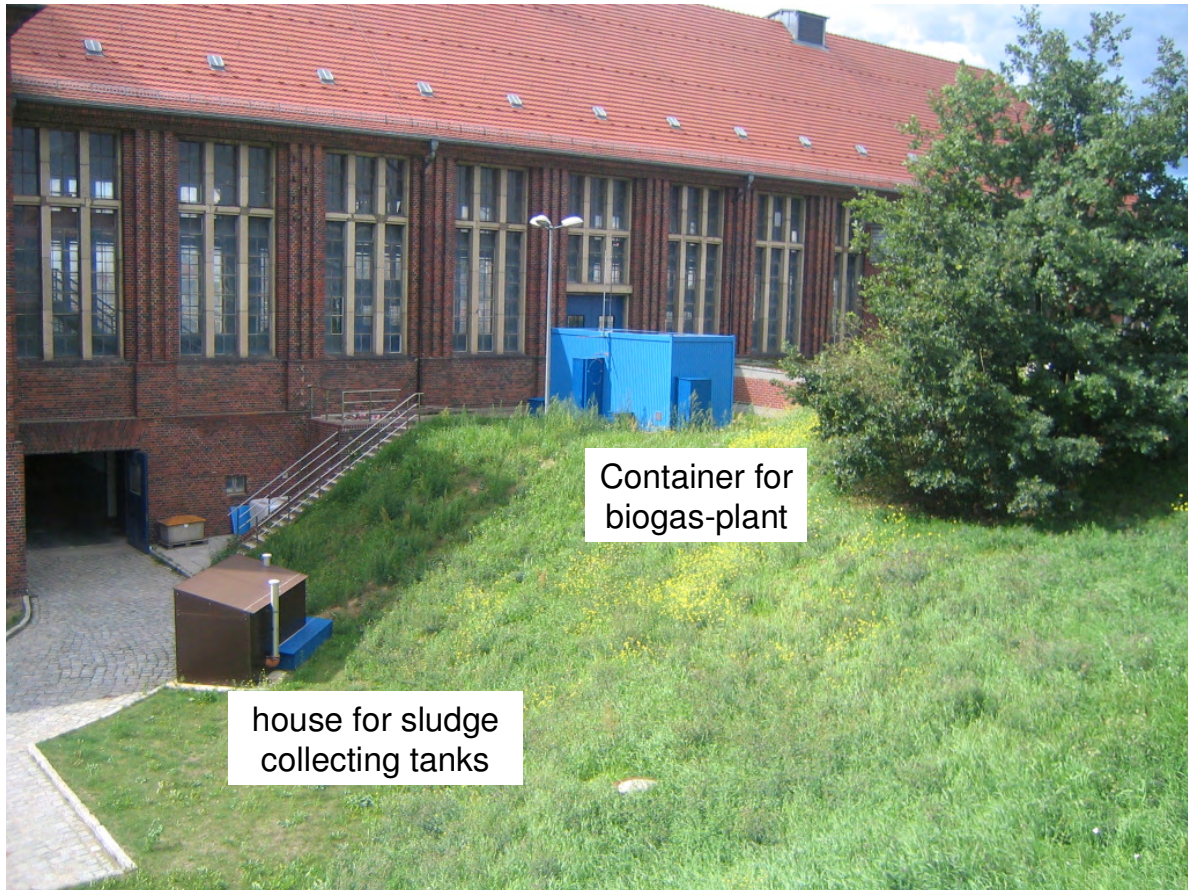

**Fig. 2.4.23:** View to the biogas plant and the protecting house for sludge storage tanks

One tank was used for collecting the digested sludge, and the other one for collecting the surplus water from settled brownwater. Because of these tanks, it was possible to measure the volume of the digested sludge and the surplus water adequately as well as to undertake proper sampling

## 2.5 Volume measurement, sampling and analytic

### 2.5.1 Volume measurement

For measurement of the volumes, different equipments listed in **Tab. 2.5.1** were installed. The positions of the pumps and of the tip water meter can be seen in **Fig. 2.3.7**.

**Tab. 2.5.1:** Volume measurement

facility	counter for operation time	volume meter	level meter	magnetic inductive flow meter	volume calculated by means of counter figures and pump diagram	volume calculated by means of counter figures and measured flow	volume derived from counter figures, volume and level meter, magnetic inductive flow meter
basement of office building: influent drinking water counter		X					X
ground floor of office building: drinking water counter for flushing of 2 toilets (men)		X					X
first floor of office building: drinking water counter for flushing of 1 toilet (women dressing room)		X					X
first floor of office building: drinking water counter for flushing of 4 toilets (2 women and 2 men toilets)		X					X
second floor of office building: drinking water counter for flushing of 2 toilets (1 women and 1 handicapped toilet)		X					X
second floor of office building: drinking water counter for flushing of 1 toilet (men)		X					X
pump 6.1	X				X		
pump 6.2	X				X		
pump 6.3	X					X	
pump 6.4	X				X		
pump A1	X				X		
pump A2	X				X		
pump B1	X				X		
pump B2	X				X		
pump C1	X				X		
pump C2	X				X		
effluent constructed wetland: tip water meter	X					X	
urine tank 1			X				X
urine tank 2			X				X
urine tank 3			X				X
urine tank 4			X				X
influent membrane bio-reactor				X			X
influent biogas-reactor			X				X

### 2.5.2 Sampling

Samples were taken at different points (**Fig. 2.3.7** and **Fig. 2.4.19**). Sampling points and the method of sampling are listed in **Tab. 2.5.2**.

**Tab. 2.5.2:** Sampling points and methods

sample point	sampling method
1.1 urine tank	grab sample after mixing the tank content
1.2a greywater pit	daily grab samples from Monday to Friday which are mixed to a composite sample before analysing
1.2 pump chamber of septic tank	24-hour composite sample taken by a automatic sampler (grab sample for bacteriological parameters according German guideline DIN 38402 A14)
1.3 effluent pit of the constructed wetland	24-hour composite sample taken by a automatic sampler (grab sample for bacteriological parameters according German guideline DIN 38402 A14)
1.4a brownwater pit	daily grab samples from Monday to Friday which are mixed to a composite sample before analysing
1.4 pumping pit of faecal filtrate	24-hour composite sample taken by a automatic sampler
1.5 effluent pit of the soil filter	24-hour composite sample taken by a automatic sampler
1.7 influent storage tank for membrane bio-reactor	24-hour composite sample taken by a automatic sampler
1.8 effluent of membrane bio-reactor	24-hour composite sample taken by a automatic sampler
membrane bio-reactor	grab sample
1.9 compost	composite sample from each finished compost
A1 brown water pit	daily grab samples from Monday to Friday which are mixed to a composite sample together with the samples from sampling point A2 before analysing
A2 brown water pit	daily grab samples from Monday to Friday which are mixed to a composite sample together with the samples from sampling point A1 before analysing
B1 grey water pit	daily grab samples from Monday to Friday which are mixed to a composite sample together with the samples from sampling point B2 before analysing
B2 grey water pit	daily grab samples from Monday to Friday which are mixed to a composite sample together with the samples from sampling point B1 before analysing
C1 urine pit	daily grab samples from Monday to Friday which are mixed to a composite sample
C2 urine pit	daily grab samples from Monday to Friday which are mixed to a composite sample
2.9 brownwater	grab sample
2.5 organic waste	composite sample from grinded organic waste
2.7a overflow balancing tank	grab sample after mixing the tank content
2.7b overflow balancing tank	grab sample
2.10 influent digester	grab sample
2.11, 2.12.1, 2.12.2, 2.12.3 biogas-plant	grab sample
2.6a digested sludge	grab sample after mixing the tank content
2.6b digested sludge	grab sample
2.13a, 2.13b biogas-plant draw-off	grab sample
2.8 biogas	grab sample

### 2.5.3 Analysis

Most of the sample analyses were carried out by the laboratories of the Berliner Wasserbetriebe (BWB). Some analyses, mainly regarding bacteriological parameters, were done by the laboratory Labor 28 (Labor 28 2005). The analyses in relation to pharmaceuticals in urine were undertaken by the laboratory IWW (Universität Duisburg 2005). All analysing methods are listed in **Tab. 2.5.3**.

For the analysis of the pharmaceutical parameters IWW used its own methods. The physical and chemical parameters were mainly measured and analysed in the BWB-laboratory of the Waßmanns-



dorf-WWTP laboratory. Some were measured and analysed in the Stahnsdorf-WWTP laboratory and in the central BWB-laboratory in Berlin-Jungfernheide.

**Tab. 2.5.3:** Analysing methods

parameter	unit	method used in central BWB laboratory	method used in WWTP-Stahnsdorf laboratory
temperature (T)	°C		pH-Meter WTW pH 340i
pH		DIN 38404-C05	pH-Meter WTW pH 340i
dissolved oxygen (DO)	mg/L		amperometric with WTW Oxi 340i (Unit: mg/l) / Hach LDO HQ10
conductivity	µS/cm	DIN EN 2788-C08	conduct meter WTW LF 196
suspended solids (SS)	mg/L	DIN EN 872	gravimetric Process
dry residue (DR)	g/L	DIN EN 12879	
TOC	mg/L	DIN EN 1484-H03	
volatile solids (VS)	%(g/kg)	DIN 38409 - H02	
COD	mg/L	38409-H41/Dr. Lange	Dr. Lange
BOD <sub>5</sub>	mg/L	DIN EN 1899-1	
N-total	mg/L	DIN 38409 - H12	Dr. Lange
NH <sub>4</sub> -N	mg/L	DIN EN ISO 11732/ Dr. Lange	Dr. Lange
NO <sub>2</sub> -N	mg/L	DIN EN 26777-D10/ Dr. Lange	Dr. Lange
NO <sub>3</sub> -N	mg/L	DIN EN ISO 10304-2	Dr. Lange
org. N	mg/L	DIN EN 25663 - H11	
PT (P-total)	mg/L	DIN EN 1189-D11- 6/Dr. Lange	Dr. Lange
PO <sub>4</sub> -Pf (dissolved orthophosphate)	mg/L	DIN EN 1189-D11- 3/ Dr. Lange	Dr. Lange
volatile fatty acid	mg/L	DIN 38414-S19	Dr. Lange
K	mg/L	DIN EN 11885-E22 ICP	
Ca	mg/L	DIN EN 11885-E22 ICP	
Mg	mg/L	DIN EN 11885-E22 ICP	
Cd	µg/L	DIN EN 11885-E22 ICP	
Cr	µg/L	DIN EN 11885-E22 ICP	
Cu	µg/L	DIN EN 11885-E22 ICP	
Hg	µg/L	DIN EN 1483-E12 AAS	
Ni	µg/L	DIN EN 11885-E22 ICP	
Pb	µg/L	DIN EN 11885-E22 ICP	
Zn	µg/L	DIN EN 11885-E22 ICP	
Cl	mg/L	Dr. Lange	
SO <sub>4</sub>	mg/L	Dr. Lange	
AOX	µg/L	DIN EN 1485	
faecal coliform germs	mpn/100 mL	MPN-method (MPN = most probable number)	
coliphage	pfu/100 mL	Berliner Wasserbetriebe laboratory house method	
intestinal entero cocci	mpn/100 mL	ISO 7899-2	
CH <sub>4</sub>	%		multi-gas measuring device GfU M600
CO <sub>2</sub>	%		multi-gas measuring device GfU M600
O <sub>2</sub>	%		multi-gas measuring device GfU M600
H <sub>2</sub> S	%		multi-gas measuring device GfU M600

### 3 Results and discussion

#### 3.1 Toilets and urinals

##### 3.1.1 Gravity separation toilet

The gravity separation toilets (see 2.4.1) used in the office building for which 6 L flushing water per flush were adjusted were, in general, suitable for separate discharge of urine and faeces. Unfortunately, it was not tested during the operation if the urine valve was fully open when the toilets were used. In April 2005, the gravity separation toilets were replaced with vacuum separation toilets (see 2.1) and subsequently stored. Most of these stored toilets were checked to see if the valves in the urine effluents had been blocked by precipitants. The valves of the toilets opened completely, and only

few precipitant products could be found on the surface of the valve and pipeline. During the entire 1 ½ years of operation, no serious technical problem occurred with these toilets in the office building.

By the end of the project in December 2006, the valves of six out of the ten toilets in the apartment house, where the gravity separation toilets had been installed in April 2005 (see 2.1), were blocked. Some were blocked after only about six months of operation. It was not possible to remove this blockage by using the chemical GreenBioClean Liquid MR 120 K-03 from Roediger or a saturated citric acid. The valves had to be removed for cleaning or to be replaced. Both chemicals were tested by the users, who applied them weekly for preventing blockage of the valves. They put about one cup of the chemical into the valve just before going to bed and let it sit until the morning. This procedure, however, could not totally prevent blockages.

In general, the experience with the operation of these toilets showed that there is considerable potential to optimise their functioning (see also 3.1.4). In future projects, the demands for optimising their use have to be met. Proposals on how to improve the toilets are the following:

- a) Change of flushing mechanism: the flushing system distributes the water to the front as well as the rear part of the toilet bowl. The relation of this flushing distribution has to be changed. The change has to result in a flushing of the front part of the bowl with approx. 90 % of the total flushing water. Only with this amount of water will a proper transport of toilet paper and possible faeces be achieved in one flush. Both flushing possibilities (low flush with approx. 3 L and high flush with approx. 6 L) have to meet these criteria. Otherwise, flushing water will be wasted;
- b) The removal of the siphon for the urine effluent has to be made much easier. The best solution should be the removal from the top, as known from waterless urinals;
- c) The position of the urine overflow losses from the upper space of the valve into the faeces outlet has to be higher. This would prevent urine loss more effectively, which can flow into the faeces effluent if piling up;
- d) The small overflow weir from the front bowl to the back faeces outlet has to be higher up. If the urine volume is high, urine can flow over the porcelain weir into the faeces effluent. More holes in the bowl for the urine effluent would prevent this urine (nutrient) loss. This solution could be realised more easily by installing a removable urine siphon with a metal cover;
- e) The adjustment of the smaller flush volume for urine flushing (low volume) should be made easier.
- f) The prerequisite for urine separation for this type of toilet is its use in a sitting position because the urine valve opens only by the body weight of the sitting person (approx. 10 – 15 kg). Unless the user sits down, urine will be discharged into the faecal outlet.

This system will not work under certain conditions:

- Many people do not want to sit when using – mainly public – toilets, based on concerns about hygiene; especially women are very sensitive to this issue.
- Many men do not sit down for urinating, especially if there is no urinal.

In either case, the urine would not be separated. This is a major disadvantage for the use of this type of separation toilet - especially in public areas.

A change in the valve opening system could be a possible way to improve this. Another solution could be the connection of the urine valve to the toilet-lid:

- toilet-lid in upright position: urine valve is open and flush water is blocked
- toilet-lid not in an upright position: urine valve is closed and flushing is possible.

In order to use a toilet-brush to clean while the toilet is flushing, the toilet lid has to be moved from the upright position and manually fixed by the user.

The disadvantage of this valve control system is that, in the upright lid position, the urine valve opens. By pouring cleaning water into the toilet, a part of this water could flow into the urine effluent and dilute the urine.

The installation of an infrared-sensor could be an alternative to the mechanical solution.

These arguments show that it is very difficult to find a solution that satisfies all requirements.

In general, mechanical or electrical solutions are possible; but mechanical solutions should be favoured in order to avoid having to mount additional electrical installations;

- g) The inner surface of the toilet should be smoother to better be able to clean it e.g. of iron-manganese sediments from flushing water.

### 3.1.2 Vacuum separation toilet

Before discussing the experience with the vacuum separation toilet, it has to be stated that this toilet is a newly developed one. Due to the small number of toilets used in the project, no company willing to develop a new toilet from scratch could be found. Therefore, existing gravity separation toilets were converted into vacuum separation toilets. This was done by equipping the flush outlets of the toilets

with a vacuum valve. Furthermore, the volume of the toilets siphon was reduced by inserting a flexible mass. The flush system was adapted to the vacuum mechanism. As a result, the toilets have to be seen rather as prototypes for testing purposes than as a properly developed type of toilet ready to be introduced to the market.

Vacuum separation toilets (see 2.4.1) were in operation in the office building (see 2.1). The first toilet for testing was installed in December 2003 in the ladies dressing room. The amount of flushing water was adjusted to 0.7 L per flush. For most uses, the flushing result was not satisfying; therefore, the additional use of the toiletbrush was necessary. But for the regular user, the flushing water volume was too low (see also 3.1.4), especially since too little water was coming from the front to flush toilet paper and, when necessary, faeces to the rear faeces effluent. Until the end of this project, there had not been any problem with the vacuum suction system. A problem, however, did occur with the flushing water valve, which is controlled by vacuum, too. This valve did not close after only two uses, resulting in water flowing over the toilet bowl. The valve was replaced. But these situations shows one disadvantage of the vacuum toilet: After the brownwater is sucked away the effluent valve is closed and water which flows into the toilet by itself due to a defect at the water valve can not flow away. Regardless of this shortcoming, in December 2004, the staff of the WWTP Stahnsdorf agreed to replace two more gravity separation toilets with vacuum separation toilets. This was done on the second floor, where most people were working. One was installed in the men's, and one in the ladies' room. The flushing water was adjusted to

- 2 L per flush in the men's room and
- 1 L per flush in the ladies' room.

Generally speaking, these toilets were accepted. The flushing results, however, were not really satisfying, and most users were bothered by the flushing noise (see also 3.1.4). Regardless of these facts, in April 2005, the staff decided again to replace six more gravity separation toilets with vacuum separation toilets. This concerned the toilets on the first floor and the ground floor. The flushing water volume of these toilets always amounted to 1 L per flush. On the whole, they were accepted, too, but with regard to flushing and flushing noise, problems arose, just as with the gravity separation toilets. Even though the six vacuum separation toilets did not have any problems related to the flushing valve as in the case described above, one toilet on the first floor got blocked in the faeces effluent. The reason for this was the green hand drying paper, which is normally used for hand drying and not for toilet purposes. In Mai 2005, the bottom for flushing the toilet in the men's room on the second floor failed to work reliably and had to be replaced. From then on, the amount of flushing water was reduced from 2 to 1 L per flush. At the same time, the amount of flushing water of the toilet in the ladies' room on the second floor was increased from 1 to 1.5 L per flush. This had been requested by the ladies using this toilet.

There is no need to mention that the vacuum separation toilets, which were converted gravity separation toilets, would have to be improved in order to be used in other projects. Most importantly, the flushing system needs to be improved. But most of the points of improvement mentioned above for the gravity separation toilets apply equally.

### 3.1.3 Waterless urinals

#### *Duravit urinal*

One Duravit urinal (see 2.4.1) was installed in the men's room on the second floor. It was used by at least four men daily from Monday to Friday. According to the maintenance manual from the Duravit company, the siphon should be cleaned once a week with water to prevent clogging by precipitant products. Avoiding a dilution of the urine, the siphon cleaning proposed in the manual was never done after starting the urinals' operation in October 2003. Only the sealing liquid for the siphon from Duravit was refilled every month, and the urinal was cleaned with the recommended cleaning liquid once a day within the regular cleaning intervals. This cleaning liquid is sprayed on the surface and dried with paper. Until December 2006, no clogging of the siphon or other problems occurred. .

#### *Ernst urinal*

Two Ernst urinals (see 2.4.1) were installed; one on the ground and one on the first floor. The urinal on the ground floor was used mainly by shift workers of the WWTP whereas the urinal on the first floor was frequented by staff members of the engineering department as well as by visitors. These urinals

were maintained twice a year by the company Renschler, an authorised maintenance provider of the Ernst company. This maintenance frequency was necessary for the office building in order to avoid clogging of the siphons. The sealing liquid for the siphon from Ernst was refilled every other week, and the urinal was cleaned once a day with the recommended cleaning liquid.

#### *Urimat urinal*

All the restrooms in which Ernst urinals were installed were also equipped with an Urimat urinal (see 2.4.1). Since smell prevention was realised with a membrane closing and opening through an electric magnet, no sealing liquid was necessary. Like the other urinals, the Urimat urinals were cleaned once a day with cleaning liquid from the Urimat company. In order to prevent clogging in the siphon, it was necessary to exchange it every three months. The opening of the urine outlet was controlled by an infrared sensor installed in the front of the urinal bowl. The Urimat urinal was positioned next to a toilet, and each user of the toilet crossed the area of the infrared-sensor. The producer was not able to give recommendations on how to decrease the sensor sensitivity. Thus, as a result of the high number of openings, triggered by users who mainly used the toilet and not the urinal, a strong ammonia smell occurred throughout the restroom.

#### *Comparison of the three urinals*

The following comparison will take into account the experience based on the daily use, regardless of the costs, because economic calculations very strongly depend on the frequency of the use of the urinals.

It can be concluded that none of the three urinals worked without causing odour-problems. Usually, the smell got stronger over the course of the day until the urinals were cleaned. The daily cleaning was therefore essential. But even water flushed urinals do not work without creating odour. The Duravit urinal had the lowest maintenance costs: it was not necessary to clean the siphon throughout the entire operation time of 2 ½ years. The Ernst urinals, by contrast, had to be maintained by a company at least twice a year. The Urimat urinals had to be maintained about four times a year, in the case of the Stahnsdorf office building also by a company.

#### *Replacement of the three urinals with Keramag urinals*

As mentioned in chapter 2.4.1, the urinals above described were replaced with Keramag urinals. The main reasons behind this decision were the odour-problems and the high maintenance costs, especially in the cases of the Urimat and Ernst urinals. The first two waterless Centaurus Keramag urinals were installed in March 2006. Twice a week, the cleaning staff removed the special effluent rubber membrane (which is installed instead of a siphon), which was easy to do. Then, they cleaned it with water in a hand washbasin. In order to clean the urinal itself, the cleaning staff sprayed cleaning liquid (leftover liquid from the Duravit company) on the surface and dried it with paper.

It can be stated, that the Keramag urinal has to be favoured over the three urinal types described above. This fact led to the decision to replace all urinals with Keramag urinals. However, since some users also complained about bad smell using the waterless Keramag urinal, it was decided to equip these urinals with a water-flush. But all the new Keramag urinals will be operated without a water-flush until user complaints get to a critical level.

### **3.1.4 User survey**

#### **3.1.4.1 Office building**

##### **3.1.4.1.1 Questionnaire**

The acceptance of separation toilets and waterless urinals by the users is the prerequisite for the implementation of new sanitation concepts. In order to get the opinion of the users, questionnaires (**Fig. 3.1.1**) were made available in each restroom of the office building.

**New sanitation concepts for separate discharge and treatment of urine  
(yellowwater), faeces (brownwater) und greywater**

Demonstration project Stahnsdorf

Here is something different!!

Save water – reduce water pollution-  
nutrients recovery and energy production

You just have used a new developed separation toilet or a waterless urinal:

***We care about your opinion...***

1. Have you seen such a toilet or urinal before?	yes <input type="radio"/>	no <input type="radio"/>				
2. Did you have any reservations concerning the use of this toilet?	yes <input type="radio"/>	no <input type="radio"/>				
3. Were you afraid to use this toilet?	yes <input type="radio"/>	no <input type="radio"/>				
4. What kind of toilet did you use?	<input type="radio"/> gravity separation toilet	<input type="radio"/> vacuum separation toilet				
5. Please assess the new toilets, comparing them to conventional toilets:	better	no difference	worse			
design	<input type="radio"/>	<input type="radio"/>	<input type="radio"/>			
flushing	<input type="radio"/>	<input type="radio"/>	<input type="radio"/>			
seating comfort	<input type="radio"/>	<input type="radio"/>	<input type="radio"/>			
hygienic feeling	<input type="radio"/>	<input type="radio"/>	<input type="radio"/>			
flushing noise	<input type="radio"/>	<input type="radio"/>	<input type="radio"/>			
6. How many times did you push the flushing button?						
• Brown water and yellow water	1time <input type="radio"/>	2times <input type="radio"/>	3times <input type="radio"/>			
• Just yellow water (small button)	1 time <input type="radio"/>	2times <input type="radio"/>	3times <input type="radio"/>			
• Just yellow water (big button)	1time <input type="radio"/>	2times <input type="radio"/>	3times <input type="radio"/>			
7. Could you imagine having such a toilet at home?	yes <input type="radio"/>	no <input type="radio"/>				
8. Assessment for urinal (just for men)						
Used urinal: Ernst <input type="radio"/> Duravit <input type="radio"/> Urimat <input type="radio"/>	better	no difference	worse			
your feeling about the missing flush	<input type="radio"/>	<input type="radio"/>	<input type="radio"/>			
hygienic feeling	<input type="radio"/>	<input type="radio"/>	<input type="radio"/>			
9. Are the instructions comprehensible?	yes <input type="radio"/>	no <input type="radio"/>				
10. Could you imagine having such a urinal at home?	yes <input type="radio"/>	no <input type="radio"/>				
Personal information	Age	< 20	20 - 34	35 - 50	51 - 65	> 65
Female. <input type="radio"/>	Male. <input type="radio"/>	<input type="radio"/>	<input type="radio"/>	<input type="radio"/>	<input type="radio"/>	<input type="radio"/>
11. Turn page over for leaving remarks and comments						

**Fig. 3.1.1:** Questionnaire for separation toilets and urinals in the office building

Among all the questions on the questionnaire, question no. 10 on whether the users could imagine using such toilets and urinals at home, is the most important one.

### 3.1.4.1.2 Users of urinals and toilets and general results

The office building staff regularly used the restrooms. This comprised four men and four women from the waste water management team and laboratory, respectively, as well as three people from the engineering department. Furthermore, the restrooms were used by the operators from the WWTP during the regular time of taking a shower. Occasionally, the restrooms were used by external visitors. By the end of the project, 85 answered questionnaires had been collected;

- 40 for the gravity separation toilets,
- 33 for the vacuum separation toilets and
- 12 exclusively for the waterless urinals.

Out of the 73 questionnaires referring to the separation toilets, 24 also contained answers regarding the urinals. **Fig. 3.1.2** shows the users broken down by age and sex.

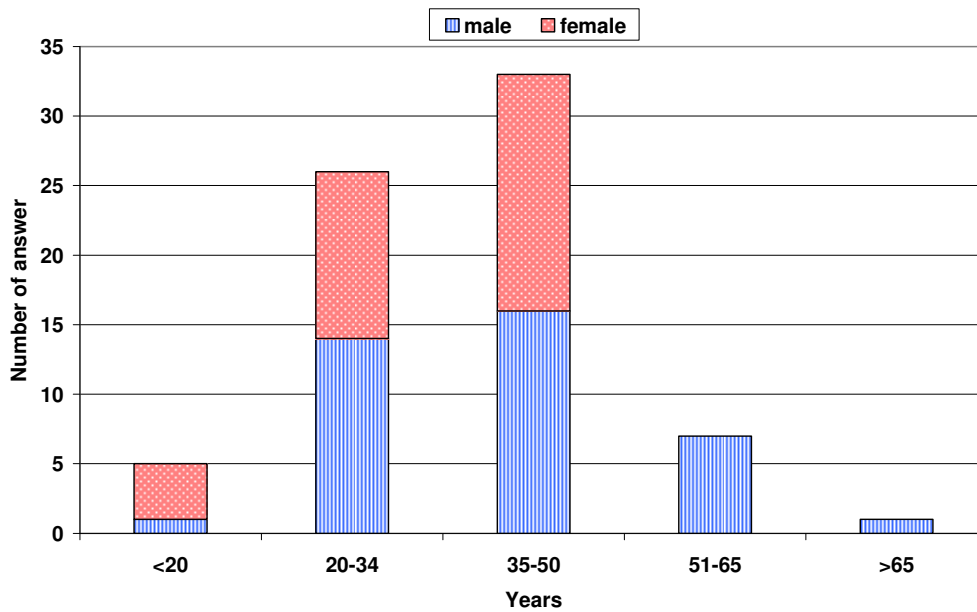

**Fig. 3.1.2:** Age and sex of the users

As the figure shows, approx. 50 % of the users who filled out the questionnaires were men, and 50 % women. Most respondents were between the ages 35 and 50, followed by the age group 20 to 34.

Question 9 of the questionnaire asked about the comprehensibility of the instruction sheets, which were available in the respective restroom (**Fig. 3.1.3** and **Fig. 3.1.4**)

# User advice

for the new developed gravity separation toilet (Roediger *No Mix Toilet*) for separate discharge of faeces and urine (without flushing)



- Please use it only sitting down
- Please stand up before flushing

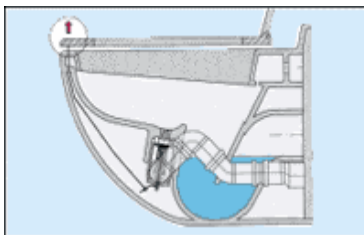

### Idle

Outlet for *urine* drainage is closed by a moveable plug

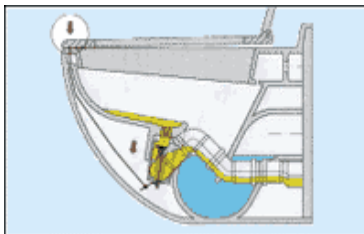

### In use

While the toilet is in use (person sitting down), the plug is mechanically opened by a lever. *urine* flows to the front inlet.

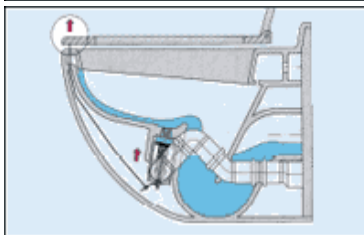

### Flushing

After the user getting up, the toilet can be flushed. While the plug for the *urine* outlet is closed, faeces and paper can be flushed out with minimal amounts of water through the rear outlet.

Fig. 3.1.3: Instruction sheet for gravity separation toilet

# User advice

for the prototype **vacuum** separation toilet  
(Roediger) for separate discharge of  
**faeces** and **urine**



- Please use it only sitting down
- Please stand up before flushing

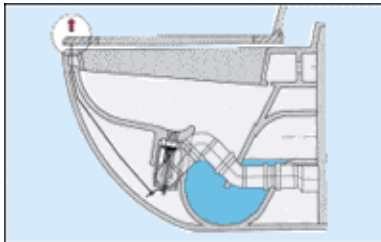

## Idle

Outlet for **urine** drainage is closed by a moveable plug

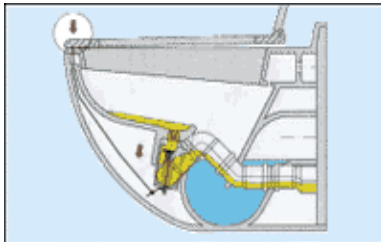

## In use

While the toilet is in use (person sitting down), the plug is mechanically opened by a lever. **urine** flows to the front inlet.

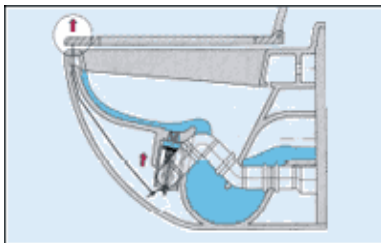

## Flushing

After the user getting up, the valve for **urine** outlet is closed and the toilet can be flushed. By pushing the flushing button 2 L flushing water will flush the faeces and toilet paper in the back which are sucked away by vacuum.

Fig. 3.1.4: Instruction sheet for vacuum separation toilet



The results of the user survey are shown in **Tab. 3.1.1** as well as the chapters below.

**Tab. 3.1.1:** Answers to general questions of the questionnaire

no. on questionnaire	question		gravity separation toilet		vacuum separation toilet	
			yes	no	yes	no
1	Have you see such toilet/urinal before?	%	24	76	33	67
2 - 3	Were you afraid to use this toilet?	%	9	91	18	82
9	Are the instructions comprehensible?	%	95	5	97	3

Most users answered “yes” for both instructions sheets. So, the function and the use of the separation toilets were understood by the users.

Question 1, “*Have you seen such a toilet or urinal before?*”, was answered with “no” for both toilets by the majority of the users. Despite of this result, the users were not particularly sceptical using the gravity separation toilets since most of them confirmed that they had no reservations about using this type of toilet (question 2, “*Where you reserved?*”). This result differs from the results for the vacuum separation toilets, for which 18 % of the users expressed having had reservations. Most users were not afraid to use these toilets, but for the vacuum separation toilet the number of non-sceptical users is smaller (question 3). These results show that most of the users are open to use or at least test new toilets.

**3.1.4.1.3 Waterless urinal assessment**

In order to assess the acceptance of the urinal by the male users, two questions were chosen: feeling about the missing flush and the hygienic feeling (question 8, **Fig. 3.1.1**). Since only a few of the 24 questionnaires concerning the used type of urinal were answered, the results do not allow to differentiate between the three urinals. It seems that the users did not recognise the different types of urinals. The answers to the above mentioned questions are shown in **Fig. 3.1.5**.

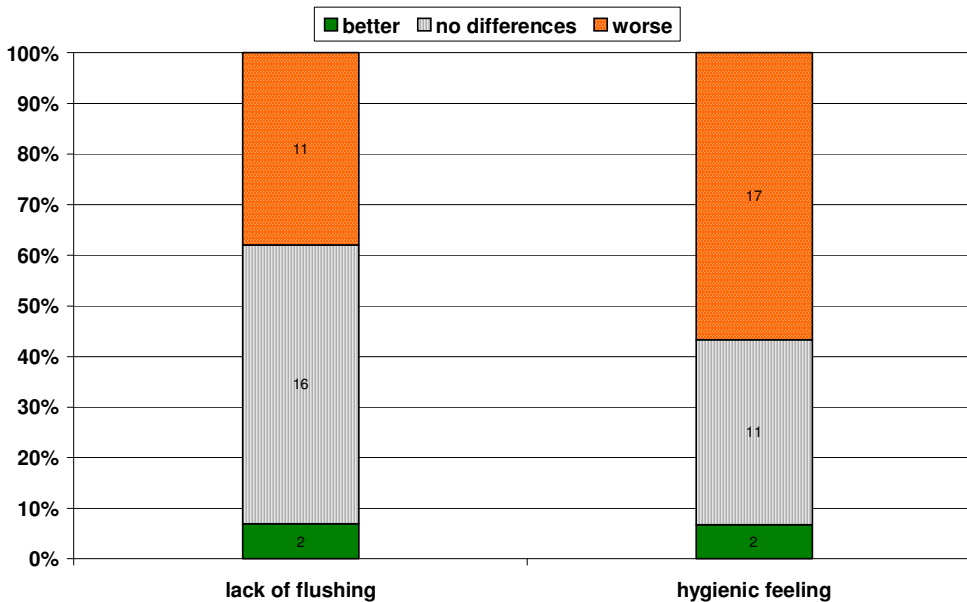
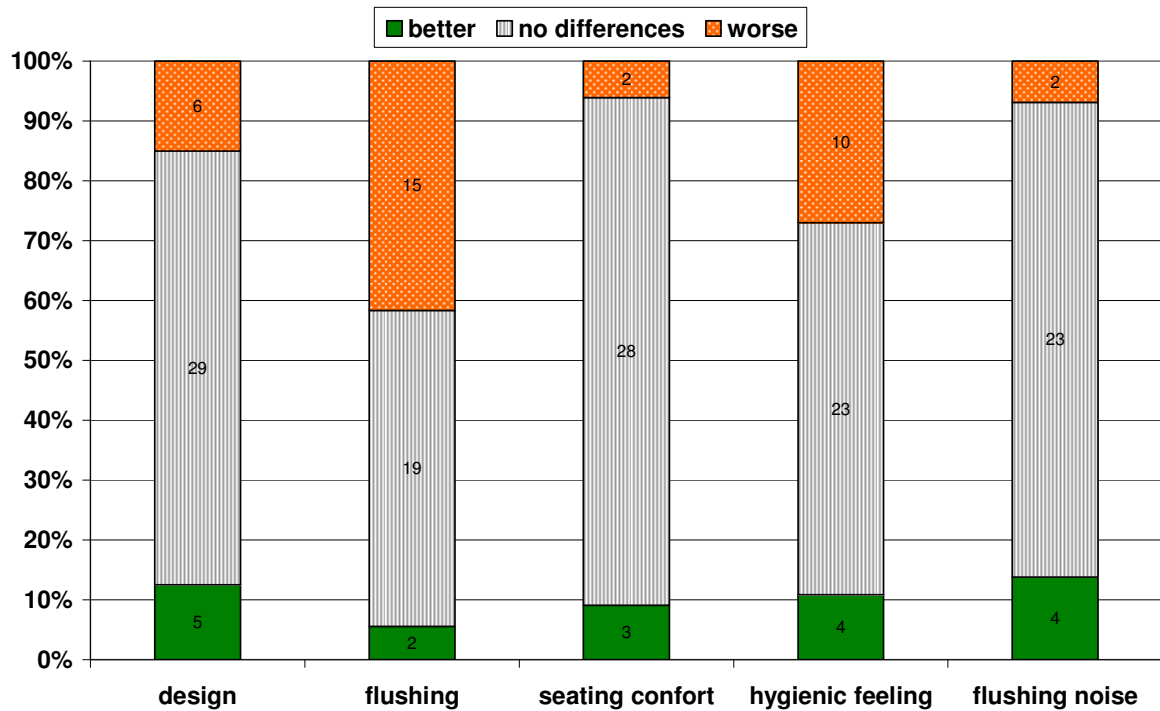

**Fig. 3.1.5:** Results of the urinal assessment

As the figure shows, approx. 62 % of the users who filled out the questionnaires did not mind the missing flush. It seems that, in principle, users accept waterless urinals. At the same time, however, approx. 57 % had a poorer hygienic feeling compared to conventional urinals. This shows that the quality of the urinals should be improved, or the awareness of the users rose through more information. The hygienic feeling could be improved, e.g. by making the urinal surface smoother to permit the urine to flow more easily to the effluent without urine drops remaining on the surface.

### 3.1.4.1.4 Gravity separation toilet assessment

Below, results of questions 5 and 6 of the questionnaire (**Fig. 3.1.1**) will be presented. The answers to question 5 are shown in **Fig. 3.1.6**.



**Fig. 3.1.6:** Results of the gravity separation toilet assessment

This figure shows that, in general, the users who answered the questionnaire did not see a difference between the gravity separation toilets and conventional toilets for most parameters. In total, approx. 70 % of the answers are “no differences” and “better”. This reflects a wide acceptance of this type of toilet. Nevertheless, two weaknesses are clearly observable: the flushing, with a dissatisfaction rate of 42 %, and the hygienic feeling, which was considered to be poorer than for conventional toilets by nearly 1 out of 3 users. These two parameters are probably linked. This shows clearly that the flushing system has to be improved - as already mentioned in chapter 3.1.1. The poor user satisfaction with regard to the flushing system is further underpinned by the fact that 57 % of the users pushed the flushing button more than once.

The acceptance of the gravity separation toilet regarding design and seating comfort is equally important. Concerning the design, only six respondents saw negative differences compared to conventional toilets. This is not surprising, given the similarity in design between this toilet and its conventional counterparts. For 94 % of the users, the seating comfort was the same or even better compared to the conventional toilets. Only few users answered that the seating comfort was poorer than for conventional toilets. In this case, the user was not satisfied with the seated position.

### 3.1.4.1.5 Vacuum separation toilet assessment

This section presents the results of questions 5 and 6 of the questionnaire (**Fig. 3.1.1**). These questions refer to the vacuum separation toilets. The answers to question 5 are shown in **Fig. 3.1.7**.

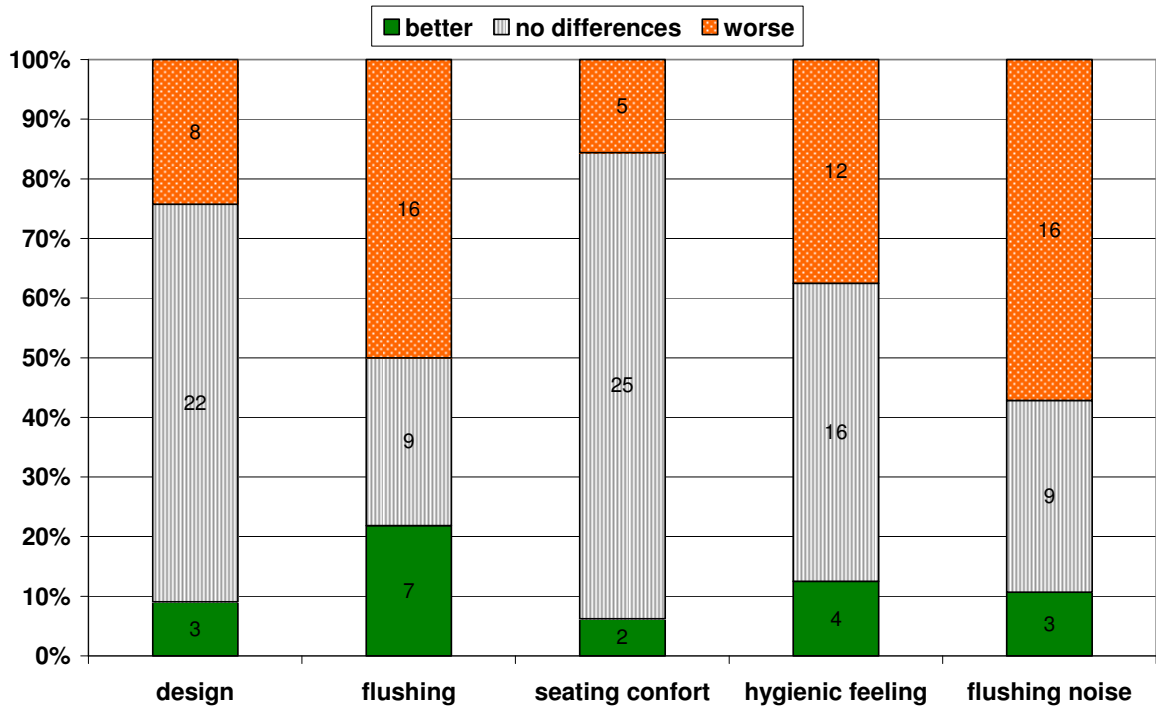

**Fig. 3.1.7:** Results of the vacuum separation toilet assessment

The results regarding the design are comparable to the results for the gravity separation toilets. This is hardly surprising, given that the vacuum separation toilets are altered gravity separation toilets (see 2.4.1). The flushing of these toilets is worse compared to conventional toilets, which has already been mentioned in chapter 3.1.2. This was confirmed by 50 % of the respondents. For cleaning the toilet, 27 % of the users pushed the flushing button twice per use, and 27% even three times. Concerning the hygienic feeling, 38 % of the users considered the hygienic feeling to be poorer than for conventional toilets. This can be linked to the flushing problem. Another weak point of this vacuum separation toilet is the flushing noise. With every flush, the vacuum valve opens and permits the faeces to be sucked off, causing a distinct sucking noise. The noise is louder compared to conventional toilets; this was expressed by 57 % of the users.

These results concerning flushing, flushing noise and hygienic feeling could easily be predicted given that the used toilets were provisional vacuum separation toilets. These toilets need to be improved, as already mentioned in chapter 3.1.2.

#### 3.1.4.1.6 Application potential for separation toilets and waterless urinals

In order to know if the users would like to use the separation toilets and waterless urinals at home, questions 7 and 10 of the questionnaire were asked (**Fig. 3.1.1**). The answers are presented in **Fig. 3.1.8**.

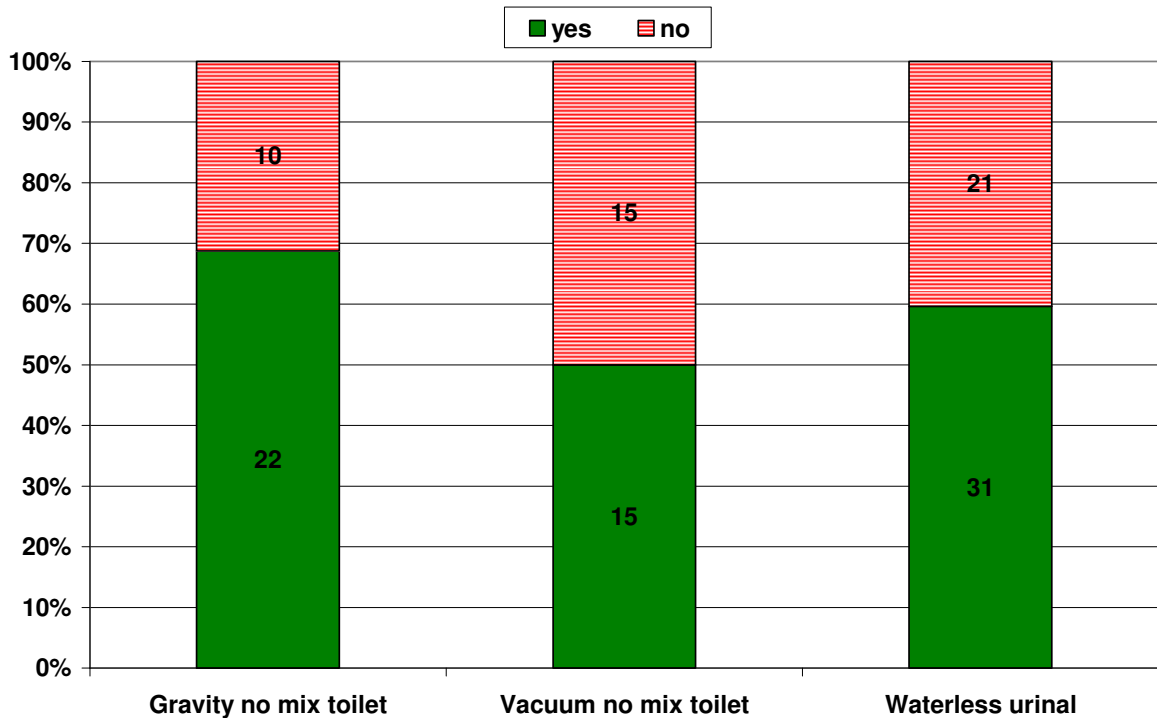

**Fig. 3.1.8:** Answers to question “Could you imagine using such toilets/urinals at home?”

The answers are mainly affirmative for the gravity separation toilets: 69 % of the respondents would accept such a toilet at home. Data analysis showed that women gave 75 % of the positive answers. Regardless of the weaknesses described above, these people could imagine using this type of toilet.

The results for the vacuum separation toilets show that only approx. 50 % of the users who filled in the questionnaire would accept such type of toilet at home. This is not surprising since the tested toilets were still provisional vacuum separation toilets.

The results concerning the urinal are mainly positive: 60 % of the respondents would accept waterless urinals at home.

### 3.1.4.1.7 Conclusion (user survey in the office building)

The results of the user survey concerning the different separation toilets and waterless urinals by means of a questionnaire show that, in general, these facilities are not rejected. Approx. 70 % of the respondents could image using gravity separation toilets at home; another 60 % would also accept waterless urinals at home; but only 50 % could imagine using vacuum separation toilets at home. Overall, these are motivating results that inspire further improvements of the separation toilets and urinals. The results presented here are based on 85 answered questionnaires.

### 3.1.4.2 Apartment house

#### 3.1.4.2.1 Questionnaire

The questionnaire used for the tenants in the apartment house was slightly different from the questionnaire used in the office building (**Fig. 3.1.9**).

**New sanitation concepts for separate discharge and treatment of urine (yellowwater), faeces (brownwater) und greywater**

Demonstration project Stahnsdorf  
Reduction of wastewater strain  
Nutrient and energy recovery  
Save water

**Dear gravity separation toilet users**

After having used the new gravity separation toilet for more than a year, we would be very interested in your opinion. The following questionnaire allows us to get your assessment of the toilets. We would be very grateful if you filled out this questionnaire (one per person). Please put the completed questionnaire in the mail box of family XXX (without putting the sender). Family XXX will forward the questionnaire to us for evaluation.

Thank you for your cooperation

Your project team

3. For female:  
Do you always seat down to urinate?  
 yes, always       not always       never

4. For male  
Do you always seat down to urinate?  
 yes, always       not always       never

5. Personal indications		Age	< 20	20 - 34	35 - 50	51 - 65	> 65
female <input type="radio"/>	male <input type="radio"/>		<input type="radio"/>	<input type="radio"/>	<input type="radio"/>	<input type="radio"/>	<input type="radio"/>

1. Please give your personal assessment of the toilets compared to conventional toilets	better	no difference	worse
design	<input type="radio"/>	<input type="radio"/>	<input type="radio"/>
flushing	<input type="radio"/>	<input type="radio"/>	<input type="radio"/>
seating comfort	<input type="radio"/>	<input type="radio"/>	<input type="radio"/>
hygienic feeling	<input type="radio"/>	<input type="radio"/>	<input type="radio"/>
flushing noise	<input type="radio"/>	<input type="radio"/>	<input type="radio"/>
cleaning	<input type="radio"/>	<input type="radio"/>	<input type="radio"/>

2. How many times did you push the flushing button?	
• Brown water and yellow water	.....time(s)
• Just yellow water (small button)	.....time(s)
• Just yellow water (big button)	.....time(s)

6. Did problems with your toilet occur? (i.e. blockages etc.)  
 yes       no  
If 'yes', which one and how often?

7. In your opinion, what could be improved in the toilet?

8. Remarks and comments

Fig. 3.1.9: Questionnaire for separation toilets in apartment house

There was a question on cleaning because most people cleaned the toilets themselves in contrast to the office building, where an external company cleaned. Furthermore, there was a question on the users' habits when urinating, which was forgotten in the questionnaire for the office building.

**3.1.4.2.2 Users of the toilets and general results**

The tested new sanitation system was installed in ten flats in the apartment house. A questionnaire was given to every person who lives in these flats. The questionnaire was anonymous. The questionnaires were distributed to the ten families corresponding to the ten flats. Nine families sent in the filled out questionnaire. This corresponds to 21 people. Below, the users who filled out a questionnaire are shown, broken down by age and sex (Fig. 3.1.10).

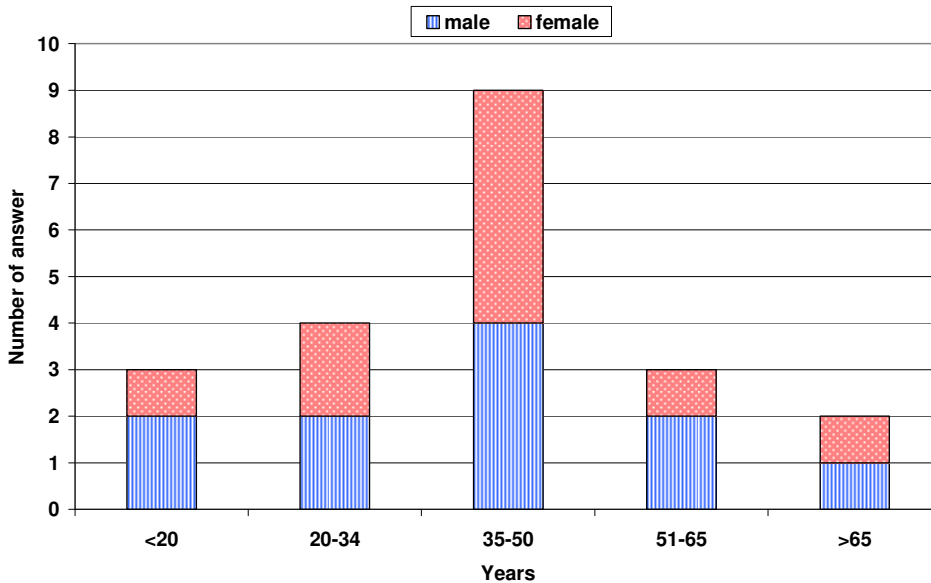

Fig. 3.1.10: Age and sex of the apartment house users

Of the answered questionnaires, 43 % were filled out by people between the ages 35 and 50, followed by 20 % filled out by people between 20 and 34. This population is mostly active. The young population (younger than 20) and the seniors (older than 65) were also represented, and accounted for 20 %

of the answered questionnaires each. The gender distribution of the respondents was very balanced, with 11 men and ten women answering the questionnaire. The answers regarding the users' habits when urinating permit to understand how the gravity separation toilets were used. The table below (**Tab. 3.1.2**) presents the answers to questions 2, 3, 4 and 6.

**Tab. 3.1.2:** Answers to general questions of the questionnaire

no. on questionnaire	Question		
2	How many time did you push the flushing button?		
	• Brown water and yellow water	time	2.8
	• Just yellow water (small button)	time	1.5
	• Just yellow water (big button)	time	1.2
	Do you always sit down to the toilet for urinating?		
3	For female:		
	yes always	%	100
	not always	%	0
	never	%	0
4	For male:		
	yes always	%	100
	not always	%	0
	never	%	0
6	Did problems with your toilet occur?		
	yes	%	56
	no	%	44

The urine separation only works if the users sit down unto the toilet seat. Questions 3 and 4 should allow evaluating if the users followed this instruction. All (100 %) of the answered questionnaires, regardless of sex, indicate that the users always sat down when urinating. These satisfying results demonstrate, that the people were willing to change their habits and to collaborate to make the project work.

Question 6 indicates that 56 % of the users were confronted with a problem of their toilet in over a year of using it. This applied to five families out of nine. This is a high rate. Most of the problems were related to a blockage of the urine valve (six families) and unpleasant smell (one family). This result indicates that this type of toilet needs to be maintained properly. The urine valve in particular seems to be a big weakness of the toilet. But it has to be mentioned that the blockage of the valve in the urine effluent did not lead to a drop out of the toilet for the users, since in this case the urine flowed into the faeces effluent.

The last general question concerned the flushing. The users were asked how many times they pushed the flushing button after using the toilet. The question differentiates between the big and the small button. The gravity separation toilets were equipped with two flushing buttons, a big one with a water consumption of six liters, and a small one with an adjusted water consumption of three liters. Out of all the respondents, a mean value was calculated. For the discharge of faeces and urine a user pushed the big flushing button on average 2.8 times. This result supports the view that the internal design of the toilet does not permit an effective flushing and that the flushing system needs to be improved.

The results for the urine discharge are equally disappointing since the users declared having pushed the small button 1.5 times, and the big one 1.2 times at each use. These results indicate that the users did not trust the flushing system and got used to pushing the flushing button several times. These habits cause water over-consumption, a consequence that contradicts the project objectives.

### 3.1.4.2.3 Gravity separation toilets

As in the case of the office building, the questionnaire asked the users about their opinion of the separation toilet in comparison with conventional toilets. The following answers were given (**Fig. 3.1.11**).

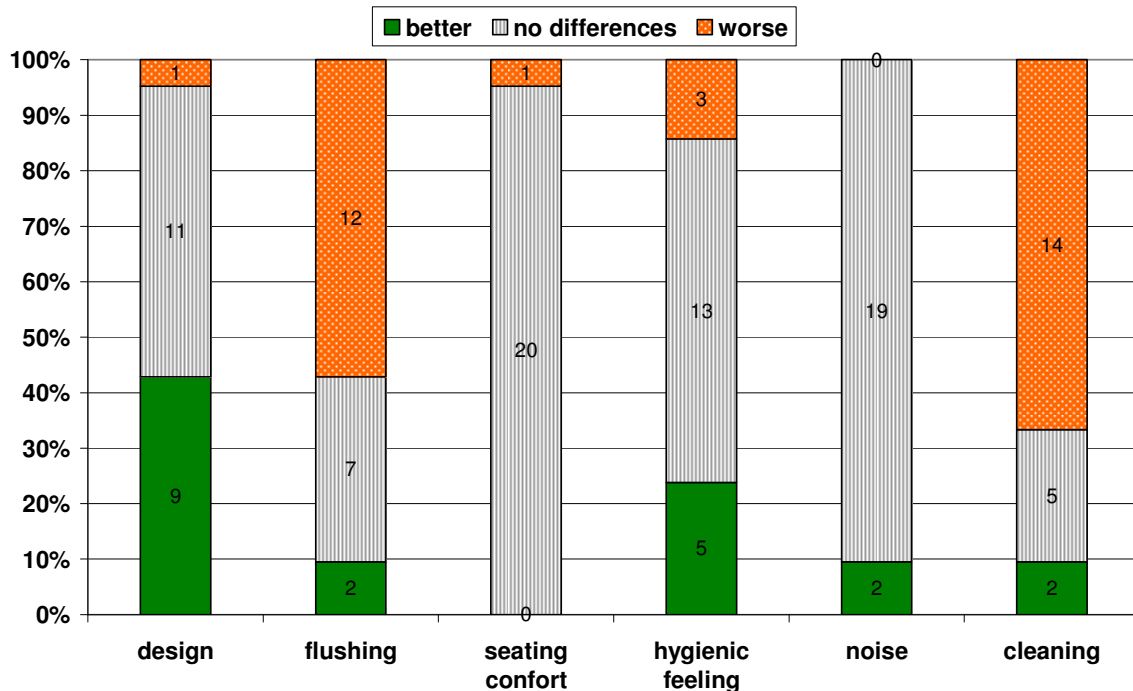

**Fig. 3.1.11:** Results of the gravity separation toilet in the apartment house

The figure above shows that the acquired information can be divided into two groups. In the first group, the results are positive for the separation toilet. Only one person was not satisfied with the design of the toilet whereas more than 40 % considered the separation toilet to have a better design than the conventional toilets. Regarding the seating comfort and the toilet noise, nearly all of the user did not differentiate between the conventional toilets and the separation toilet. The hygienic feeling also obtained affirmative answers: 85 % of the users expressed that the hygienic feeling was as good as or better than for a conventional toilet.

The second group of data underlines the weaknesses of the separation toilets. With regard to the question concerning the toilet flushing, 57 % of the users considered the flushing of the separation toilet to be worse than that of a conventional one. This dissatisfaction is stronger than the one observed in the office building (42 %). The non-effective flushing obliged the users to flush several times every time they used the toilet - as shown in **Table 3.1.2**. Similarly, the cleaning of the toilet appears to have been problematic. A vast majority, namely 67 % of the apartment house habitants, declared that the separation toilets were more difficult to clean than the normal toilets. The users complained about the surface area of the toilet, where yellowish marks, which were difficult to get rid of, would appear.

#### 3.1.4.2.4 Conclusion (user survey in the apartment house)

The survey results show that the users generally accepted the toilet. They followed the users' instructions by sitting down when urinating. Moreover, they were satisfied with the design of the toilet and did not notice a difference in hygienic feeling. Nevertheless, the users became aware of the weakness of the flushing system, which obliged them to push the flushing button several times after using the toilets. A non-optimal flushing increases overall water consumption and is a real problem with regard to achieving the multiple goals of new sanitation concepts. Improvements in this field are necessary in order to increase user acceptance and to expand on the installation of these types of toilets.

### 3.2 Pipes

The different pipes for grey-, brown- and yellowwater installed in the wake of this demonstration project are mentioned in chapter 2.4.2. The experiments with these pipes did not register any problems throughout the project. Two acrylic glass pipes were installed in the yellowwater pipes for observation purposes. In one of the pipes only very few, and in the other one, where most toilets and urinals were connected, the sediments had a height of approx. 5 mm at the bottom at the pipes.

For the transport of the urine from the apartment house to the storing tanks in the office building the urine is pumped via a pressure pipe. Due to the lack of experience of pumping the urine the application has been one of the first installations. Up to today no problems in the pipe due to precipitation or clogging occurred. Up to now a pumping of urine in pressure pipes seems to cause no problems.

### 3.3 Vacuum plant

The vacuum plant (see 2.4.3) is in operation since December 2003, when the first vacuum toilet was installed (see 3.1.2) in. No serious problems occurred throughout the project. One important condition for a reliable operation is a regular service. This service had to be done once a year for the plant in the office building. It also included the maintenance of different vacuum equipments from each vacuum separation toilet, such as e.g. cleaning of the one-way valves in the vacuum tubes near the interim storage tanks.

One serious problem with a control valve from the interim storage tank of the first installed vacuum separation toilet occurred very soon after starting the operation. It had to be exchanged.

In general, using a vacuum system for sanitation concepts is an interesting option. The vacuum separation toilets need much less flushing water, and the brownwater is higher concentrated than when using gravity separation toilets, which is an additional advantage for further treatments like digestion. Disadvantages of a vacuum system are the higher technical expenses and the energy necessary for its operation. With regard to the energy, it has to be taken into account that less flushing water (mostly drinking water) is needed and less wastewater has to be transported to the treatment facilities such as WWTP. The data on energy consumption for the most relevant topics regarding the operation of the vacuum separation toilets in the office building in Stahnsdorf are given in **Tab. 3.3.1**.

**Tab. 3.3.1:** Energy demand for the operation of the vacuum separation toilets in the office building

<b>brownwater discharge and toilet characteristics</b>		
brownwater quantity	L/d	62 (V7)
flushing water volume	L/flush	1
daily toilet flushings	1/d	62
<b>energy demand: vacuum pump</b>		
power vacuum pump	W	1500
air flow vacuum pump	m <sup>3</sup> /h	63
sucked air per flush	L/flush	33
daily pump working time	h/d	0,032
daily energy demand	Wh/d	49
<b>energy demand: brownwater pump</b>		
power brownwater pump	W	2000
flow brownwater pump	m <sup>3</sup> /h	12
brownwater per flush	L/flush	1
daily pump working time	h/d	0,005
daily energy demand	Wh/d	10
<b>energy demand: warm-up of the vacuum pumps</b>		
working time	h/d	1
number of vacuum pump	-	2
daily energy demand	Wh/d	3000
<b>energy demand vacuum plant</b>		
sum of energy demands	Wh/d	3059
measured energy demand	Wh/d	2635
theoretical sepc. energy demand without energy for warm-up of vacuum pumps	Wh/L	0,95

For the transport of 62 L/d brownwater, 2,635 Wh/d electric energy was necessary. This was measured by an energy measurement. This energy, however, was necessary for the whole vacuum plant, which is operated with two vacuum and two wastewater pumps. Since this vacuum plant is the smallest one built by the company Roediger, and it could operate about 40 toilets, of which only 9 are connected, each vacuum pump has to be automatically operated for one hour each day in order to re-



move condensed water which could get into the oil of the pumps. In order to verify if the theoretical energy demand corresponded to the measured energy, it was calculated how much energy was used by the vacuum pumps for building up the vacuum, by the wastewater pumps for pumping the brownwater into a pumping station and for warming-up the vacuum pumps. The sum of this theoretic energy demand is 3,059 Wh/d and is close to the measured one mentioned above. The theoretic specific energy demand just for building up the vacuum and for the wastewater pump is 0.95 Wh/L.

A comparison of the energy demand for vacuum and gravity separation toilets operated in the office building in Stahnsdorf with a scenario with optimised toilets is given in **Tab. 3.3.2**.

**Tab. 3.3.2:** Energy demand for the operation of vacuum and gravity separation toilets of the office building in Stahnsdorf for two scenarios (real values in Stahnsdorf and for optimised separation toilets)

		vacuum separation toilets		gravity separation toilets	
		Stahnsdorf	optimized	Stahnsdorf	optimized
toilet flushing water volume	L/flush	1	1,5	6	6
number of flush per toilet use (assumed)	-	3	1	1,5	1
real flushing water volume per toilet use	L/use	3	1,5	9	6
energy demand for drinking water production and transport (BWB)	Wh/L	0,55			
energy demand for drinking water production and transport per toilet use	Wh/use	1,65	0,83	4,95	3,30
energy demand for brownwater discharge to pumping station (vacuum pump and brownwater pump for vacuum toilets; gravity for gravity toilets)	Wh/use	127.5 <sup>1)</sup>	1.43 <sup>2)</sup>	-	
energy demand wastewater pumping station to WWTP (BWB)	Wh/L	0,16			
energy demand wastewater pumping station to WWTP per toilet use	kWh/use	0,48	0,24	1,44	0,96
total energy demand per toilet use	Wh/use	129,63	2,50	6,39	4,26

1) calculated with the measured value from the vacuum plant including the warm-up phase of the two vacuum pumps (see **tab. 3.3.1**)

2) calculated with theoretical value (0.95 Wh/L (see **tab. 3.3.1**)) without warm-up phase of the vacuum pumps

The figure used for the specific energy consumption relating to drinking water production and transport as well as to wastewater pumping to the pumping station are mean values of the Berliner Wasserbetriebe (BWB). The very high energy demand of the vacuum separation toilets in the scenario Stahnsdorf is mainly due to the warming-up of the vacuum pumps (see above). If the size of a vacuum plant is proportional to the number of the operated toilets, this additional energy should not be necessary. In the case of the scenario with optimised toilets, it is assumed that less flushing water is necessary. Furthermore, it is assumed that the brownwater from the gravity separation toilets does not have to be pumped, but is flowing by gravity since, compared to the vacuum separation toilets, more flushing water is used. The comparison of the total energy demand per toilet use for the scenario with the optimised toilets shows that less energy seems to be necessary for the sanitation concept with vacuum separation toilets. This is a very interesting result that should inspire further developments in the field of vacuum sanitation.

### 3.4 Collected urine

The collection of urine from the office building started in October 2003, collection from the apartment house in October 2005. The urine from the office building flowed by gravity into the urine tanks in the cellar of the office building (see 2.4.4). The urine from the apartment house was pumped into these tanks. The daily flow of urine from the office building from October 2003 to October 2005 is shown in **Fig. 3.4.1**. From October 2005 to the end of the project, the urine from this building mainly flowed into the WWTP of Stahnsdorf, since urine from the apartment house was collected in these tanks.

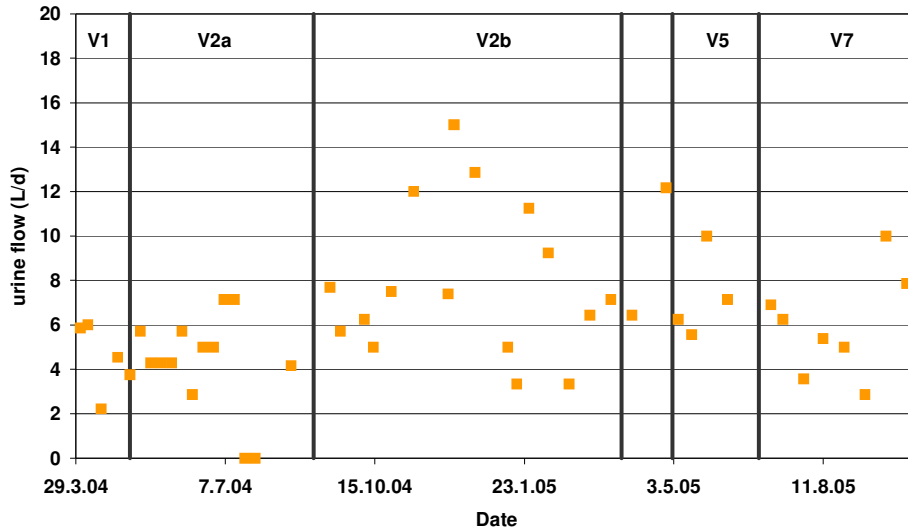

**Fig. 3.4.1:** Daily flow of urine from the office building

This figure shows that the average amount of urine from the office building was approx. 7 L/d.

As mentioned above, the collection of urine from the apartment house started in October 2005. But after approx. three months, it became obvious that, due the way the different pipes had been installed, the urine would get diluted from time to time. Additional factors, such as the very cold winter, rendered it impossible to solve the problem before October 2006. This is why in the following **Fig. 3.4.2** the volume of the urine from the apartment house is shown only for a short period of time.

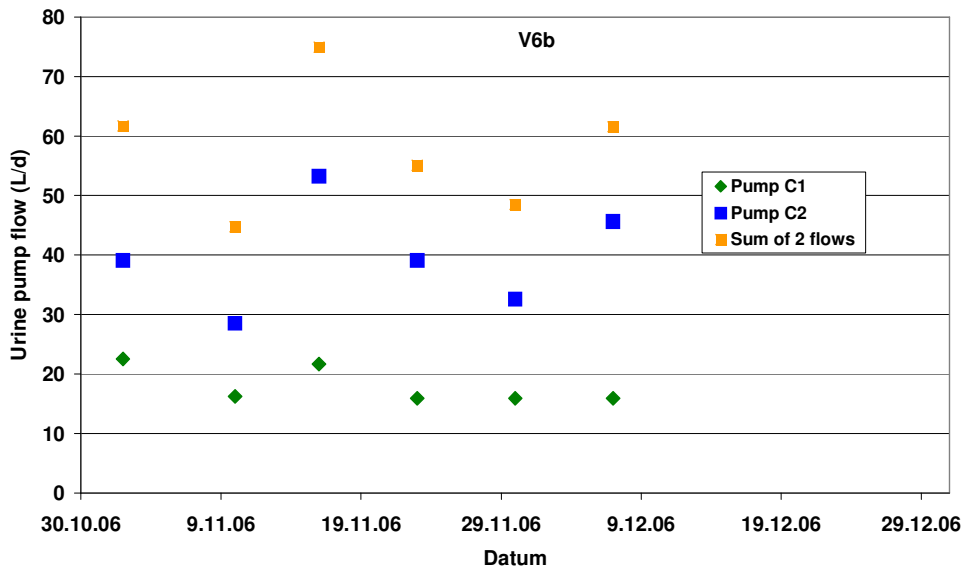

**Fig. 3.4.2:** Daily flow of urine from the apartment house

This figure shows the urine flows from both pits as well as the total flow, which amounted to approx. 60 L/d. The flow from the north part of the apartment house (pump C2) was higher than the flow of the south part of the apartment house (pump C1), even though both parts of the building nearly had the same number of users of the gravity separation toilets. Because of this difference in flow-volume, the most probable reason for the higher volume was a dilution of this urine by an unknown source. This had happened before in the case of the urine from the south part of the apartment house. The dilution of the urine from the north part of the apartment house was confirmed by the analysis of the concentrations of the different analysed parameters listed in **Tab 3.4.1**. These show representative concentrations in the collected urine from the office building, from the apartment house, from the urine of one project team member as well as concentrations given in relevant publications.

**Tab. 3.4.1:** Concentration (mean values) of chemical and physical parameters in different urine

sampling point		office building	apartment house			urine of one member of the project team		literature*
			tank	pit 1	pit 2	pit 1 + pit 2	morning urine	
flow	L/d	7	19	40	59	1.2	1.2	-
pH		8.9	-	-	8.6	-	-	9.1
conductivity	μS/cm	36,616	-	-	15,200	-	-	-
SS	mg/L	463	-	-	160	-	-	-
COD	mg/L	8,217	4,315	1,800	2,610	12,014	10,989	10,000
N <sub>org</sub>	mg/L	198	157	150	153	8,132	7,748	1,100
NH <sub>4</sub> -N	mg/L	3,647	1,842	1,300	1,475	426	405	8,100
NO <sub>2</sub> -N	mg/L	0.53	0.1	0,1	0.1	1.4	0.4	-
NO <sub>3</sub> -N	mg/L	< 0.3	6	2.9	4	20.5	23.2	-
N-total	mg/L	3,939	2,000	1,450	1,627	8,582	8,163	-
P-total	mg/L	402	263	150	186	878	706	540
K <sup>+</sup>	mg/L	2,100	631	300	407	1,700	2,066	2,200
Cl <sup>-</sup>	mg/L	513	-	-	1,660	-	-	-
Ca <sup>2+</sup>	mg/L	45	-	-	23	-	-	-
Mg <sup>2+</sup>	mg/L	14	-	-	7	-	-	-
Cd <sup>2+</sup>	μg/L	< 3	-	-	< 3	-	-	-
Cr <sup>3+</sup>	μg/L	< 5	-	-	< 5	-	-	-
Cu <sup>2+</sup>	μg/L	2,000	-	-	380	-	-	-
Hg <sup>2+</sup>	μg/L	< 0.2	-	-	1.5	-	-	-
Ni <sup>2+</sup>	μg/L	< 10	-	-	< 10	-	-	-
Pb <sup>2+</sup>	μg/L	< 15	-	-	< 15	-	-	-
Zn <sup>2+</sup>	μg/L	960	-	-	115	-	-	-

\* (Udert et al. 2004)

The concentrations of the parameters from the north part of the apartment house (pit 2) are approx. half as high as the concentrations of the parameters from the south part (pit 1).

The comparison of the urine from both buildings shows that the urine from the office building has higher concentrations than the urine from the apartment house. But the concentrations in both urines are far lower compared to the values found in relevant publications. In order to find out if the concentrations in the urine should be at the levels given in relevant publications, one male project team member took samples of his urine twice daily for one week. He took his first urine sample in the morning, and the second one from the rest of the day. The results are presented in **Tab. 3.4.1**. As the data show, the concentrations correspond to the ones given in relevant publications. The morning urine sample has concentrations that are only slightly higher than the rest of the day sample. The concentrations of NH<sub>4</sub>-N and N<sub>org</sub> differ from the concentrations given in relevant publications, but the total amount of nitrogen is very similar. Based on these results, it can be concluded that both urines, the samples from the office building as well as from the apartment house, must be diluted. Unfortunately, the reason for this dilution remains unclear. In the case of the apartment house, one reason can be found in the dilution in the piping (see above). In the case of the office building, however, this should not apply, but it cannot be guaranteed that there had not been a misconnection in a pipe. The urine could have become diluted by the users flushing the toilet while still sitting down on the toilet seat, since the valve in the urine effluent would have been open at that moment. Unfortunately, this possibility was not covered by the questionnaire. Regardless of this, however, mass balances in chapter 3.6 show that the flows and concentrations in **Tab. 3.4.1** are plausible.

The listed values in the column "pit 1 + pit 2", for which no value is given in the columns "pit 1" and "pit 2", are from analysed urine from the apartment house. It was collected in urine tanks and had nearly the same COD-, N-total- etc. concentration as in column "pit 1 + pit 2". The values for heavy metals in the urine of both buildings show that mainly Cu and Zn could be detected. These metals probably originate from the main of the drinking water pipes.

In addition to chemical parameters, the urine from both buildings were also tested for micro pollutants at IWW-laboratory (Universität Duisburg 2005). The results are listed in **Tab. 3.4.2**

**Tab. 3.4.2:** Concentrations of micro pollutants in the urine from the office building and from the apartment house

urine tank		1	1	2	3	4	2	4	2	2
sampling day		22.4.04	29.10.04	15.3.05	15.3.05	10.6.05	7.11.05	6.12.05	18.1.06	11.8.06
building		office building	office building	office building	office building	office building	office building	apartment house	apartment house	apartment house
filling time	month	3	3	6	5	5	5	1	1	1
storage time	month	2.5	6.5	8	3	1	1	2	0	0
<b>lipid reduction</b>										
Clofibrinsäure	µg/l	3.7	< 1.0	< 1	< 1	< 1	< 1	< 1	< 1	< 1
Bezafibrat	µg/l	485	2,200	2.7	< 1	1,029	988	1,810	120	< 1
Fenofibrat	µg/l	< 1.0	< 1.0	< 1	< 1	< 1	< 1	< 1	< 1	< 1
<b>analgetika/antiphlogistika</b>										
Diclofenac	µg/l	8.2	13	33.8	33.7	8.5	9.5	28.2	8.4	< 1
Fenoprofen	µg/l	1.6	< 1.0	< 1	< 1	< 1	< 1	< 1	< 2	< 1
Ibuprofen	µg/l	570	600	370	436	263	445	1500	101	55.7
Indometacin	µg/l	< 1	< 1	< 1	< 1	< 1	< 1	< 1	< 1	< 1
Phenactecin	µg/l	< 1	< 1	< 1	< 1	< 1	< 1	< 1	< 1	< 1
Phenazon	µg/l	< 3	< 3	15.5	< 3	< 3	< 1	1.2	< 1	< 1
Ketoprofen	µg/l	-	42	3.2	1.8	< 1	< 1	< 1	< 1	< 1
<b>antiepileptika and blood circulation increasing substances</b>										
Carbamazepin	µg/l	< 1	< 1	1.5	1.4	7.9	27.7	3.2	1.6	< 1
Pentoxifyllin	µg/l	< 1	< 1	< 1	< 1	< 1	< 1	< 1	< 1	1.26
<b>natural und synthetic hormones</b>										
3-Hydroxyestra-1,3,5(10)-trien-17-on	µg/l	< 10	< 10	< 10	< 10	< 10	< 10	< 10	< 10	< 10
17a-Ethinyl-1,3,5(10)estratrien-3,17β-diol	ng/l	-	-	< 50	< 50	< 50	< 50	< 50	< 50	< 50
17 ( - Ethinylestradiol	µg/l	< 50	< 50	-	-	-	-	-	-	-
( - Sitosterol	µg/l	2.5	< 2	< 1	< 1	5	13	17	24.2	133

The results in this table represent only urine from users of the office building and the apartment house and are not representative for a huge population (the sample size is small). The choice of micro pollutants analysed was based on results of previous research.

As the table shows, the concentration levels of most micro pollutants are below a detectable level (<). The increased storage time of the urine from tank 1 from 2.5 to 6.5 months did not induce significantly lower concentration levels. The significantly higher concentration level of Benzafibrat may have been caused by the analysing procedure.

The urine from both buildings was also screened for bacteriological parameters (**Tab. 3.4.3**).

**Tab. 3.4.3:** Bacteriological values of the urine from the office building and from the apartment house

urine tank		1	2	3	4	2	4	2	2
sampling day		25.02.05	25.02.05	25.02.05	10.6.05	7.11.05	6.12.05	18.1.06	11.8.06
building		office building	office building	office building	office building	office building	apartment house	apartment house	apartment house
filling time	month	2.5	7	5	5	5	1	1	1
storage time	month	13	7	2	1	1	2	0	0
colonies at 22 °C	PFU/ml	60	10	440	3,900	400	2,700,000	2,800,000	40
colonies at 36 °C	PFU/ml	270	10	440	2,400	460	3,800,000	600,000	54
coliform bacteria	PFU/100 ml	0	0	0	0	0	0	0	0
E. coli	PFU/100 ml	0	0	0	-	-	30,000	3,100	-
Salmonella	in 100 ml sample	negative	negative	negative	negative	negative	negative	negative	negative
Clostridium perfringens	in 50 ml sample	negative	negative	negative	negative	1	> 200	450	negative

In none of the samples coliform bacteria and Salmonella could be detected. Clostridium perfringens was negative in most cases. After storage times of 2 to 13 months, no E. coli could be detected in the urine from office building. This was different in the case of the urine from the apartment house: After a storage time of two months, high levels of E. coli were detected. These results show that a storage time of two months seems to be too short to disinfect the urine.



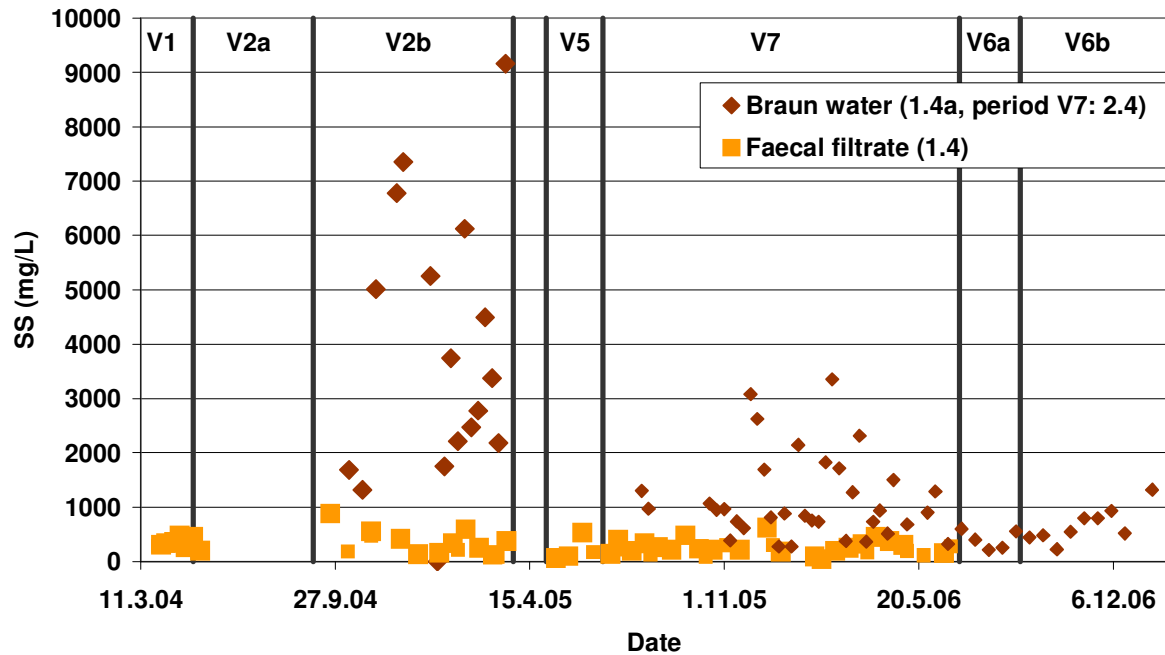

**Fig. 3.5.2.2:** SS concentrations in brownwater in the infl. and effl. of the faeces separator during the different variants (24 h-composite samples)(1.4, 1.4a and 2.4 are samplings points, see **Fig. 2.3.7**)

During *Variant V2a.*, no samples were taken from brownwater since it was being diverted to the WWTP at that time (see 2.3). Sampling of the influent started with *Variant V2b.* No influent sampling was undertaken during *Variant V5*, since brownwater from only one gravity separation toilet was pumped into the separator. Influent sampling was taken up again during *Variant V7*, when brownwater from the apartment house was pumped into the faeces separator. During *Variant V6a* and *V6b*, the faeces separator was out of operation.

As the results for *Variant V2b* in this figure shows, the SS influent concentration varied between a fairly wide range, namely between 1,000 and 9,000 mg/L. The most likely reason for this variation is the way the sampling was done (see 2.5.2). Since no reliable automatic sampler was available for taking a representative sample of the inhomogeneous brownwater, samples had to be taken manually. These samples were grab samples, taken always daily from Monday to Friday. These grab samples were mixed to a one week composite sample. The same way of sampling was also used for brownwater sampling from the apartment house (*Variant V7*). During this variant, the SS influent concentration was much lower than in *Variant V2b*. One reason for the lower concentration is that there were not any urinals installed in the apartment house. Thus, the brownwater got mixed by the flushing water from cleaning the toilet after urinating. Furthermore, most users mainly used the big flushing button and pushed it approx. three times because they were not satisfied with the flushing (see 3.1.4).

The SS effluent concentration of the separator was mostly lower than 500 mg/L. The level of the effluent concentration did not change when the filter bags were changed to bags with a larger pore size in May 2005. The mean values of SS and other parameters for *Variant V2b*, which had the longest operation time, and for which influent and effluent values were available, are listed in **Tab. 3.5.2.1**.

**Tab. 3.5.2.1:** Efficiency of faeces separator; influent (sampling point 1.4a) and effluent (sampling point 1.4) concentration and elimination of different parameters (24 h-composite samples, mean values) in brownwater

		Variant V2b (4.9.04 - 29.3.05)				Variant V7 (29.6.05 - 1.7.06)			
		influent 1.4a (office building)	effluent 1.4	elimination	elimination (%)	influent 2.4 (apartment house)	effluent 1.4	elimination	elimination (%)
flow	L/d	169	168			945	943		
temperature	°C		7				11		
pH			7.53				7.76		
O <sub>2</sub>	mgO <sub>2</sub> /L		5.6				7.9		
SS	mg/L	4,104	331			1,151	246		
COD	mgO <sub>2</sub> /L	4,774	1,007			2,036	1,023		
BOD	mgO <sub>2</sub> /L	1,565	354			721	406		
N-total	mgN/L	156	64			174	141		
NH <sub>4</sub> -N	mgN/L	23	27			106	110		
org. N	mgN/L	133	35			66	30		
P-total	mgP/L	40	20			31	16		
PO <sub>4</sub> -P <sub>f</sub>	mgP/L					14	11		
SS	g/d	692	56	637	92	1,087	232	855	79
COD	gO <sub>2</sub> /d	805	169	635	79	1,924	965	959	50
BOD	gO <sub>2</sub> /d	264	59	205	78	681	383	299	44
N-total	gN/d	26	11	16	59	165	133	32	19
NH <sub>4</sub> -N	gN/d	3.96	4.57	-0.61	-15	100	104	-3.53	-4
org. N	gN/d	22	5.91	16	74	63	29	34	54
P-total	gP/d	6.81	3.39	3.42	50	30	15	15	50
PO <sub>4</sub> -P <sub>f</sub>	gP/d					14	11	3	21

The influent and effluent flow was always nearly at the same level in both cases, since the volume of the solids in the brownwater was very low compared to the liquid one. The aim of the faeces separator was the elimination of undissolved substances in the brownwater. Contrary to other separation technologies, such as e.g. sedimentation, a collection of dry material is wanted. The dissolved substances are supposed to pass the separator, while a small part may be adsorbed by the organic solids. As the data show, by far the largest amount of SS (92 % and 70 %, respectively) remained in the filter bags. But the SS effluent concentration of 331 mg/L and 246 mg/L, respectively, is still fairly high. The nitrogen parameters show that, in the influent, most of the nitrogen was organic. In total, 59 % of nitrogen could be retained in the faeces separator in the case of the office building, but only 19 % in the case of the apartment house. The phosphorus retention rate was 50 % in both cases.

The data in this table show that, in general, the separation of solids could be achieved in a highly efficient way. Better results were obtained during the operation with brownwater from the office building: In this case, the average hydraulic load of the faeces separator was 0.4 L/(L<sub>separator</sub> · d). This might be the optimum load that should not be exceeded.

The experiences with this faeces separator show that it is appropriate for single houses or small settlements. However, it cannot be used for large settlements because this requires a separation facility that works continuously.

### 3.5.3 Compost technique

As described in chapter 2.4.7, dewatered faeces were brought to the experiment field of the Humboldt University Berlin for composting twice. One load of dewatered faeces was composted inside and the other one outside a building (see 2.4.7). The main results of the composting process are given in **Tab. 3.5.3.1**.

**Tab. 3.5.3.1:** Data of the faeces composts

		<b>Compost 1</b>	<b>Compost 2</b>
composting place		inside building	outside building
fill time of filter bags	date	11.3.04 - 20.9.04	13.12.05 - 3.5.06
	month	~ 6	~ 5
composting time	date	20.9.04 - 26.4.05	3.5.06 - 23.1.07
	month	~ 7	~ 9
composting temperature	°C	~ 20	outside temperature
compost mass	kg	~ 60	~ 80
dried solid content	%	40.6	26.5
dried solids (DS)	kg	~ 25	~ 21
org. dried solid content	%	79.9	69
N total	%	2.73	2.90
N Kjeldahl	mg/kg DS	13,600	24,020
P total	mg/kg DS	3,400	11,250
Potassium (K)	mg/kg DS	2,800	9,800
Calcium (Ca)	mg/kg DS	23,000	29,000
Cadmium (Cd)	mg/kg DS	1.5	0.56
Chrome (Cr)	mg/kg DS	25	14
Copper (Cu)	mg/kg DS	210	710
Magnesium (Mg)	mg/kg DS	1,500	3,200
Nickel (Ni)	mg/kg DS	22	12
Lead (Pb)	mg/kg DS	30	12
Zink (Zn)	mg/kg DS	720	430
Mercury (Hg)	mg/kg DS	0.44	5
colony count at 22 °C	cfu/1mL	3,300,000	64,000,000
colony count at 36 °C	cfu/1mL	3,700,000	74,000,000
E-coli	cfu/g	11,000	< 10,000
coliform germs	cfu/g	340,000	125,000
Clostridium perfringens	cfu/g	0	< 1,000
Salmonellen	1/g	positiv	negativ

The faeces of compost 1 were collected over a period of approx. six months and were composted for approx. seven months. The compost mass weighed 60 kg, with a dried solid content of 40.6 %. The degree of mass reduction of the thickened faeces during composting could not be determined since the mass of the thickened faeces had not been determined before composting. The faeces of compost 2 were collected over a period of five months and were composted for nine months. The mass was reduced from 114 to 80 kg (30 %) during composting. The content of dried solids amounted to 26.5 %, which is far less than the solid content of compost 1. The concentration levels or values of most parameters of compost 2 were significantly higher than those of compost 1. The most likely reason for this could be differences in nutrition between the toilet users of either building.

### 3.5.4 Soil filter

The soil filter (see 2.4.8) was used at the beginning of the project in order to treat the filtrate from the faeces separator. It was supposed to remove already pathogenic germs before subsequent treatment through the constructed wetland together with pre-settled greywater. But after approx. five weeks of operation, clogging and blockages occurred in the soil filter. The reason for this was a higher than expected loading with solids of the faeces filtrate. Because of this, the operation of the soil filter was stopped on May 5, 2005. This operation period is referred to as *Variante V1* (see also 2.3).

In order to keep track of the performance of the soil filter, two measurement points were taken into account: point 1.4 (effluent of the faeces separator and influent of the soil filter) and point 1.5 (effluent of the soil filter). **Fig. 3.5.4.1** shows the influent and effluent concentration of the suspended solid for the period of *Variante V1*.



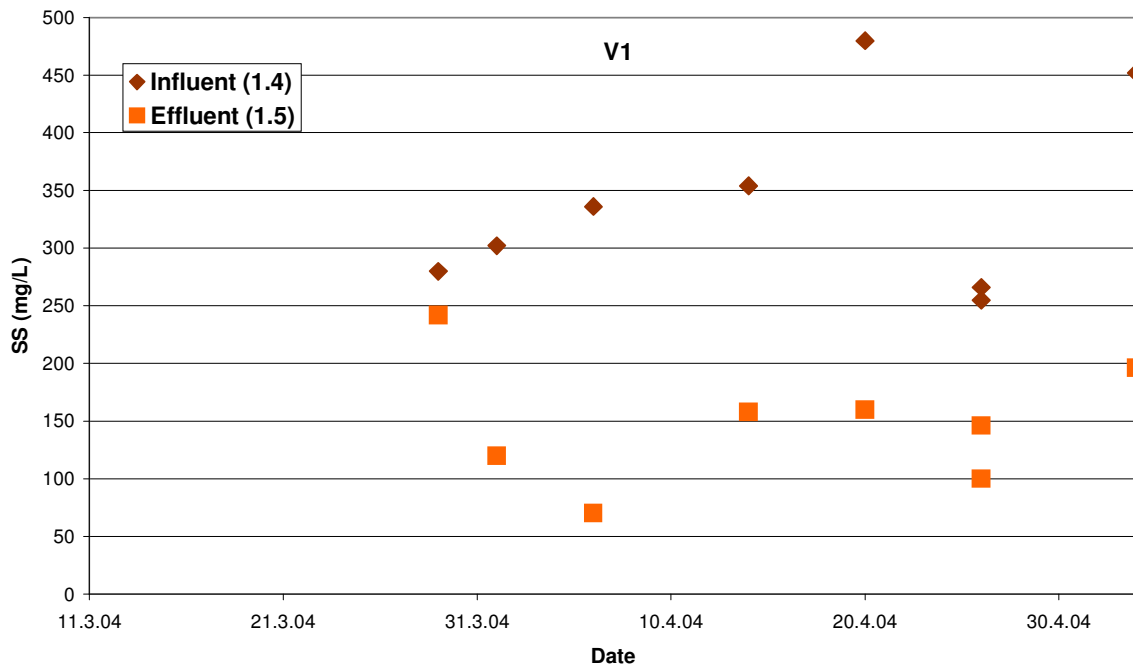

**Fig. 3.5.4.1:** Influent and effluent SS-concentration of the soil filter (24 h composite sample)

As the figure show, the influent concentration fluctuated between 250 mg/L and 500 mg/L, and the effluent concentration between 70 mg/L and 250 mg/L.

In **Tab. 3.5.4.1** mean values of different parameters from the soil filter are presented.

**Tab. 3.5.4.1:** Influent and effluent concentrations of different parameters of the soil filter (mean value)

		Variant V1 (11.3.05 - 5.5.04)			
		influent (1.4)	effluent (1.5)	elimination	elimination (%)
$Q_d$	L/d	144	144		
$q_A$	$m^3/(m^2 \cdot h)$	0,0075	0,0075		
Temperature	$^{\circ}C$	16	13	3	16
pH		7,5	7,3	0,2	3
Conductivity	$\mu s/cm$	1478	1582	-104	-7
$O_2$	mg/L	1,0	1,8	-0,8	-75
SS	mg/L	341	149	192	56
COD	mg/L	910	534	376	41
N org	mg/L	40	22	18	45
$NH_4-N$	mg/L	27,7	30,1	-2,3	-8
$NO_3-N$	mg/L	1,8	1,0	0,8	44
$NO_2-N$	mg/L	0,3	0,1	0,2	74
P-total	mg/L	15,7	10,2	5,5	35
$PO_4-Pf$	mg/L	12,1	9,1	3,0	24
TOC	mg/L	141	138	3	2
BOD	mg/L	360	70	290	81
SS	g/d	49	22	28	56
COD	g/d	131	77	54	41
N org	g/d	6	3	3	45
$NH_4-N$	g/d	4,0	4,3	0	-8
$NO_3-N$	g/d	0,25	0,14	0,11	44
$NO_2-N$	g/d	0,04	0,01	0,03	74
P-total	g/d	2,26	1,47	0,8	35
$PO_4-Pf$	g/d	1,75	1,32	0,4	24
TOC	g/d	20,3	19,9	0,4	2
BOD	g/d	51,9	10,1	42	81

The flow was assumed to be the same for the influent and the effluent and is listed as an average value of the period. The flow through the soil filter during *Variant V1* was 144 L/d, which was lower than the expected flow rate of 685 L/d (see table **Tab. 2.4.2**). The soil filter was designed to treat the

entire faeces filtrate of the faeces separator, i.e. the faeces coming from the apartment house as well as the office building. During *Variant V1*, only the office building was connected to the facilities.

As the table shows, 56 % of SS could be removed. Other substances connected to the SS were also partly removed, the elimination rate of COD e.g. being 41 %. Since, from the beginning, the operation of the soil filter was not satisfying, no bacteriological parameters were analysed.

The soil filter was not operated again in the project. A reliable operation of the filter can only be guaranteed if the SS-concentration in the faeces filtrate does not exceed 50 mg/L. This, however, was not feasible with the faeces filter bags used (see 2.4.6).

### 3.5.5 Septic tank

The septic tank was the “pre-treatment step” before the constructed wetland. The main treatment process consisted of sedimentation. The volume treated during the different variants is shown in **Fig. 3.5.5.1**.

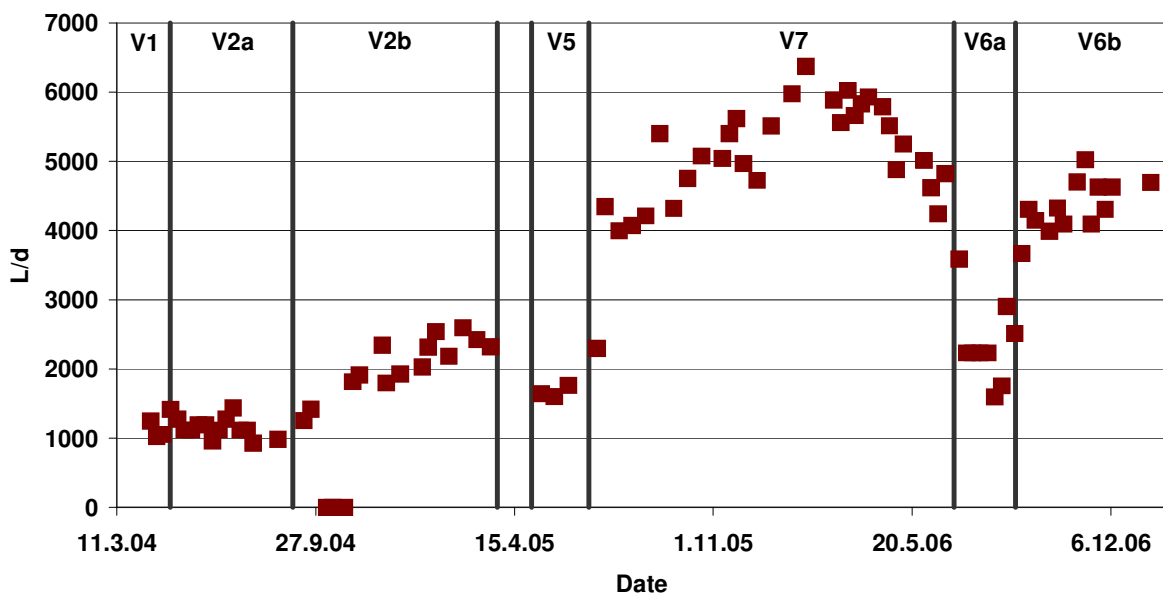

**Fig. 3.5.5.1:** Influent flow of septic tank

During *Variant V1*, the flow consisted of greywater from the office building and of faecal filtrate from the effluent of the soil filter. In the period of *Variant V2a*, only greywater from the office building was fed into the flow. For *Variant V2b*, the influent consisted of greywater from the office building and of faecal filtrate from the faecal separator. When running *Variant V5*, the influent comprised almost only greywater from the office building, since, at that time, only one gravity separation toilet was connected to the faeces separator, and this toilet was used very rarely. During *Variant V7*, the influent consisted of greywater from the office building and from the apartment house as well as of faeces filtrate from the faeces separator, that was fed almost exclusively with brownwater from the apartment house. When running *Variant V6a*, only greywater from the apartment house was treated. During *Variant V6b*, greywater from both buildings was pumped into the septic tank (see also 2.3).

As **Fig. 3.5.5.1** shows, the flow increased from approx. 1,300 L/d in *Variant V1* to approx. 6,000 L/d in *Variant V7*. The flows from *Variants V1 to V5* and *Variant V6a* were lower than the targeted flow of 4,580 L/d. The flow during *Variant V7* was most of the time higher than the targeted flow. Only during *Variant V6b* did the flow correspond to the targeted flow. The retention time of the different flows in the septic tank is visualised in **Fig. 3.5.5.2**.

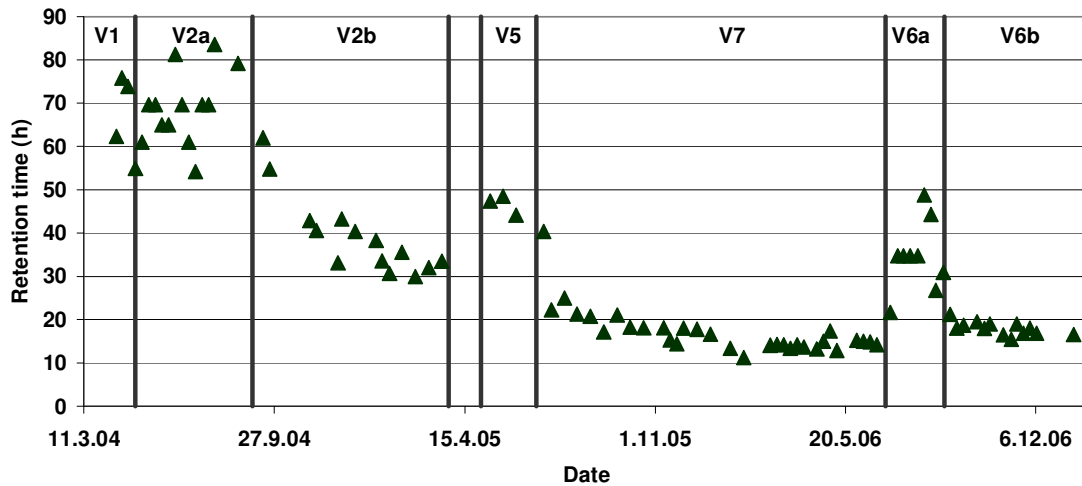

**Fig. 3.5.5.2:** Retention time of the flow in the septic tank

During the *Variants V1 to V5* and *Variant V6a*, the flow was retained for a very long time because of the low flows. The calculated retention time was 3.7 h for the operation situation, with the septic tank half filled with sludge (see 2.4.9). At the end of April 2005, the quantity of solids at the bottom of the septic tank was checked. The result was, that there was no significant solids layer. This was proved accurate when the septic tank was cleaned on May 2nd, 2005. Only approx. 4 kg of solids could be detected. This procedure was repeated a year later with nearly the same results. This is why the retention time in **Fig. 3.5.5.2** was calculated based on the entire useful volume of the two chambers of the septic tank. This led to a retention time of 10 to 20 hours during *Variant V7* and *Variant V6b*, when the hydraulic load corresponded to the targeted load.

The quality regarding SS in the effluent of the septic tank is demonstrated in **Fig. 3.5.5.1**.

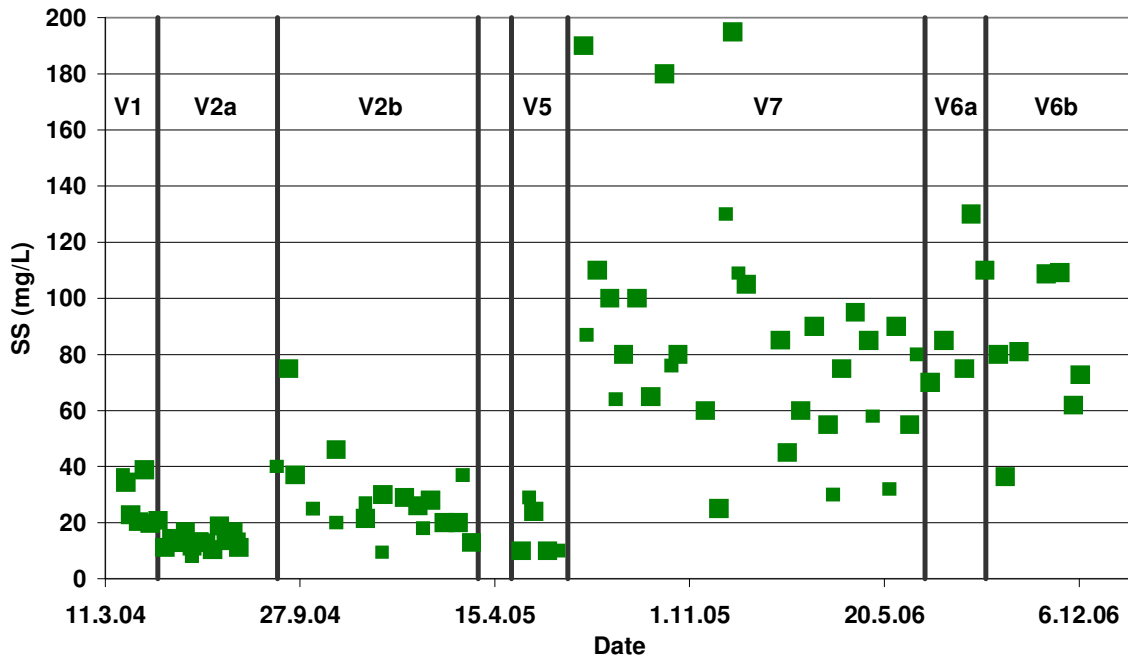

**Fig. 3.5.5.3:** SS-concentration in the effluent of the septic tank (24 h-composite sample)

In all the variants before *Variant V5*, the SS-concentration was mostly lower than 40 mg/L. The higher hydraulic loads after *Variant V5* led to a much higher SS effluent concentration. A concentration level

higher than 100 mg/l (or 5 g SS/(m<sup>2</sup> d)) should be avoided since this may lead to the clogging of the constructed wetland (Winter and Goetz, 2004).

The different influent and effluent loads as well elimination rates of the most important parameters from most analysed variants are shown in **Tab. 3.5.5.1**. Since during the *Variants V1 to V2b* no sampling of the influent was undertaken, in this table, no data could be given for these variants.

**Tab. 3.5.5.1:** Influent and effluent loads as well elimination efficiency of the septic tank during the different variants

parameter	unit	V5	V7	V6a	V6b
variant start		02.05.05	29.06.05	01.07.06	01.09.06
greywater from		office building	both buildings	apartment house	both buildings
faeces filtrate		with	with	without	without
<b>flow</b>					
influent	L/d	1.419	5.246	2.364	4.385
effluent	L/d	1.419	5.246	2.458	4.857
<b>retention time</b>	h	47	17	35	19
<b>temperature</b>	°C	17	13	16	14
<b>pH</b>		7,6	7,3	7,6	7,7
<b>conductivity</b>					
influent	µs/cm	1.192	1284	1.349	1.253
effluent	µs/cm	1.135	1.468	1.440	1.340
<b>SS</b>					
influent	g/d	97	639	267	551
effluent	g/d	28	505	216	374
elimination	%	71	21	19	32
<b>COD</b>					
influent	gO <sub>2</sub> /d	315	2.588	1.503	1.854
effluent	gO <sub>2</sub> /d	169	2.214	1.008	1.521
elimination	%	46	14	33	18
<b>BOD</b>					
influent	gO <sub>2</sub> /d	119	1.069	580	817
effluent	gO <sub>2</sub> /d	78	998	172	806
elimination	%	34	7	70	1
<b>N total</b>					
influent	gN/d	15	222	23	56
effluent	gN/d	14	179	35	51
elimination	%	10	19	-54	9
<b>NH<sub>4</sub>-N</b>					
influent	gN/d	1,03	90	7	13
effluent	gN/d	3,34	119	11	23
elimination	%	-224	-32	-58	-80
<b>NO<sub>2</sub>-N</b>					
influent	gN/d	0,07	0,44	0,14	0,22
effluent	gN/d	0,04	0,32	0,11	0,29
elimination	%	49	28	24	-35
<b>NO<sub>3</sub>-N</b>					
influent	gN/d	0,45	2,64	0,85	1,46
effluent	gN/d	0,40	2,58	1,90	1,49
elimination	%	10	2	-123	-2
<b>org. N</b>					
influent	gN/d	14	63	18	42
effluent	gN/d	4	63	22	31
elimination	%	68	1	-20	25
<b>P-total</b>					
influent	gP/d	3,42	41	16	31
effluent	gP/d	3,28	36	15	22
elimination	%	4	10	9	29
<b>PO<sub>4</sub>-Pf</b>					
influent	gP/d	1,72	25	13	18
effluent	gP/d	2,69	27	11	18
elimination	%	-56	-6	19	0

As the data in this table show, the SS elimination rate was between 19 % and 71%. The very high elimination rate of 71 % was only achieved with a very long, unrealistic retention time of 47 h. The elimination rates for N-total were between 9 % and 19 %. The increase of the N-total load during *Variant V6a* is not plausible, since the SS load decreased during this variant. The P-total elimination rates were between 4 % and 29 %.

At the beginning of the project it was assumed, that approx. 20 % to 30 % of the SS could be removed. This had been the case for the tested variants. But it should also be possible to reach elimination rates like this with much shorter retention times.

For getting an idea of the two greywaters from the office building and the apartment house, concentrations from different parameters are given in **Tab. 3.5.5.2**.

**Tab. 3.5.5.2:** Comparison of the greywaters from the office building and the apartment house

		greywater	
		Variant V5 office building	Variant V7 apartment house
	unit		
SS	mg/L	58	228
COD	mgO <sub>2</sub> /L	189	783
BOD	mgO <sub>2</sub> /L	72	338
N-total	mgN/L	9	13
NH <sub>4</sub> -N	mgN/L	0,43	0,70
NO <sub>2</sub> -N	mgN/L	0,04	0,06
NO <sub>3</sub> -N	mgN/L	0,27	0,48
org. N	mgN/L	8,28	12,03
P-total	mgP/L	2,05	8,22
PO <sub>4</sub> -P <sub>f</sub>	mgP/L	1,03	4,44
K	mgN/L	5,73	8,79

The figures in this table show that the concentrations of the greywater from the apartment house were in general higher compared with the concentrations from the greywater of the office building.

### 3.5.6 Constructed wetland

The efficiency of the treatment of the different wastewater flows in the constructed wetland were assessed by using the concentration curves as well as the mean values of loadings presented in the table at the end of this chapter (**Tab. 3.5.6.1**). In this table, all removal rates were calculated based on the loads. Detailed information is given below, describing the calculations concerning the nitrogen removal. The constructed wetland was operated under different conditions. All concentrations given in the discussion below are the mean value of each variant listed in **Tab. 3.5.6.1**. The variation of the concentrations can be seen in the graphs.

The hydraulic load in the influent and effluent of the constructed wetland for all variants is presented in **Fig. 3.5.6.1**.

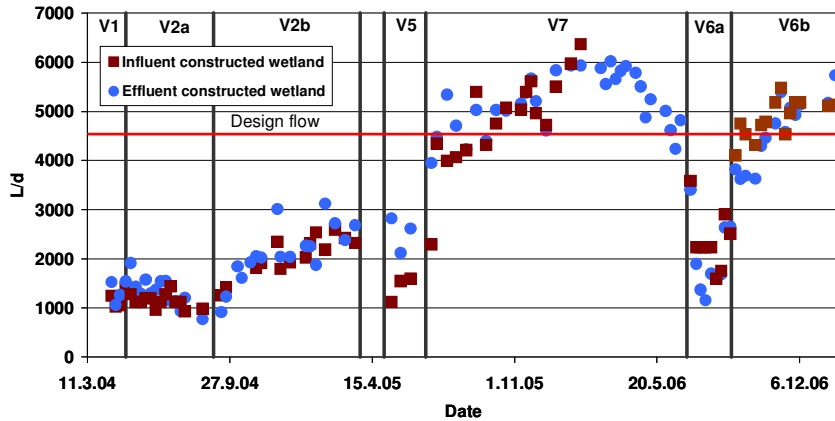
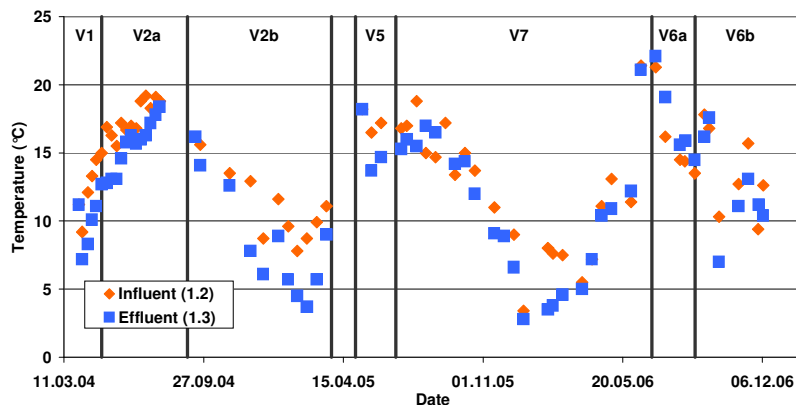

**Fig. 3.5.6.1:** Influent and effluent flow of the constructed wetland

This figure shows an increase of volume during *Variant V2b* and again during *Variant V7*. The first increase was caused by more users in the office building, and the second increase by connecting the flats from the apartment house to the treatment facilities. Higher flows in the effluent were mostly caused by stormy weather. The higher effluent flow during *Variant V5* was mainly due to the fact that the retrofitted layer (April 2005, see 2.4.10) was irrigated with process wastewater (which was micro filtered effluent from the WWTP Stahnsdorf) for better growth of the plants. Some higher effluent flows during *Variant V1* and *V2a* may also have been caused by problems with volume measuring at that time. The flow during *Variant V7* was mostly higher than the anticipated value of 4,580 L/d. For the time period of February to the end of *Variant V7*, no influent values are given in **Fig. 3.5.6.1**. This is because, in this period, clogging occurred, and great quantities of water flowed back to the septic tank, which, in turn, had to be pumped again each time. This led to an influent flow that could not be considered representative. In order to counteract the clogging, in July 2006, only half of the constructed wetland was operated, with the greywater from the apartment house only; in August 2006, the other half of the wetland was operated. During *Variant V6b*, the entire constructed wetland could be operated again with greywater from both buildings. An overview of the different types of influent during the different variants is given in **Tab. 3.5.6.1**.

The temperature curves (**Fig. 3.5.6.2**) show the changes of season. During summertime, the temperature of the wastewater increased to up to 22°C. During wintertime, the temperature of the wastewater went down to less than 5°C.

This variation in temperature also influences the biological activity of the micro organisms living on the surface of the filter grains.



**Fig. 3.5.6.2:** Temperature of the influent and effluent of the constructed wetland

The COD as parameter for organic pollution can be seen in **Fig. 3.5.6.3**.

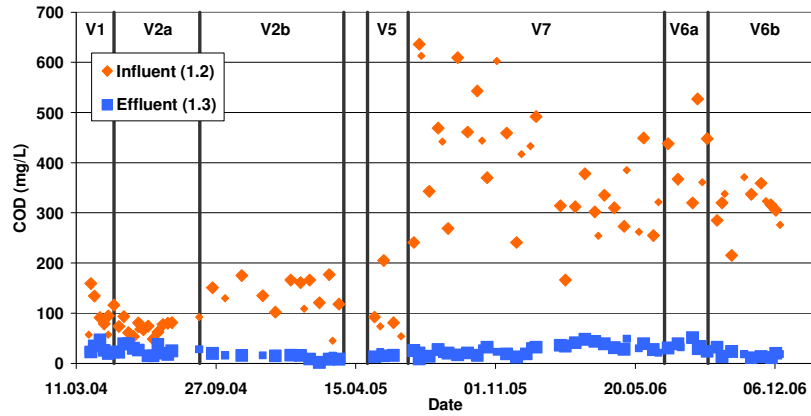
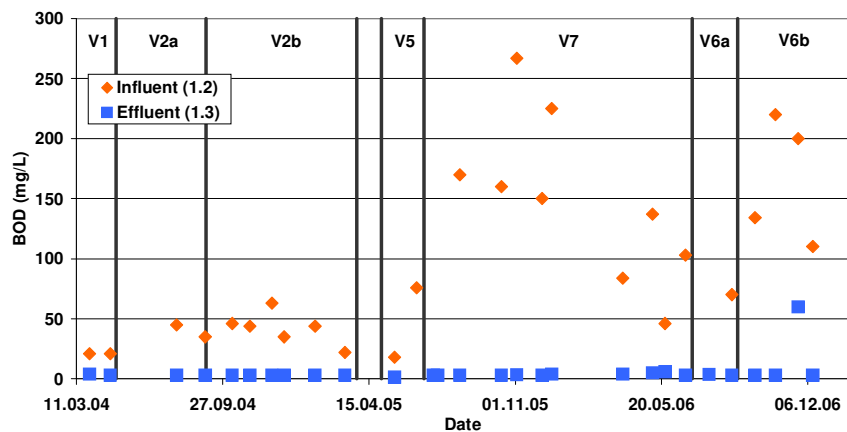

**Fig. 3.5.6.3:** COD of the influent and effluent of the constructed wetland (24 h composite sample)

From *Variant V1* to *V 5*, the greywater consisted mainly of the water from showers, hand wash basins, and dishwashers in the office building. Only the greywater without faecal filtrate after sedimentation had low mean (average) concentration (levels) (*V2a*). The concentration (level) increased by adding the filtrate of the soil filter (*V1*). When the brownwater was only treated by a faeces separator, the concentration level went up (*V2b* and *V5*). Compared to greywater from households (kitchen, bathrooms, washing machine etc.; *V6a*), concentration levels are very low - and far lower, indeed, than the concentration levels used to dimension the constructed wetland. The higher concentration levels during *Variant V7* resulted from the greywater including faeces filtrate of both buildings, whereas during *Variant V6b*, they resulted only from the greywater of both buildings.

The constructed wetland was significantly underloaded in the first phases of the project. Therefore, the low COD effluent values are not surprising. But the effluent concentration did not change much during the significantly higher influent concentration and load, respectively (**Tab. 3.5.6.1**).

The BOD<sub>5</sub>-values are of course lower than the COD-values, but they show the same behaviour (**Fig. 3.5.6.4**).



**Fig. 3.5.6.4:** BOD<sub>5</sub> of the influent and effluent of the constructed wetland (24 h composite sample)

The influent and effluent nitrogen concentrations of the constructed wetland are shown in **Fig. 3.5.6.5**.

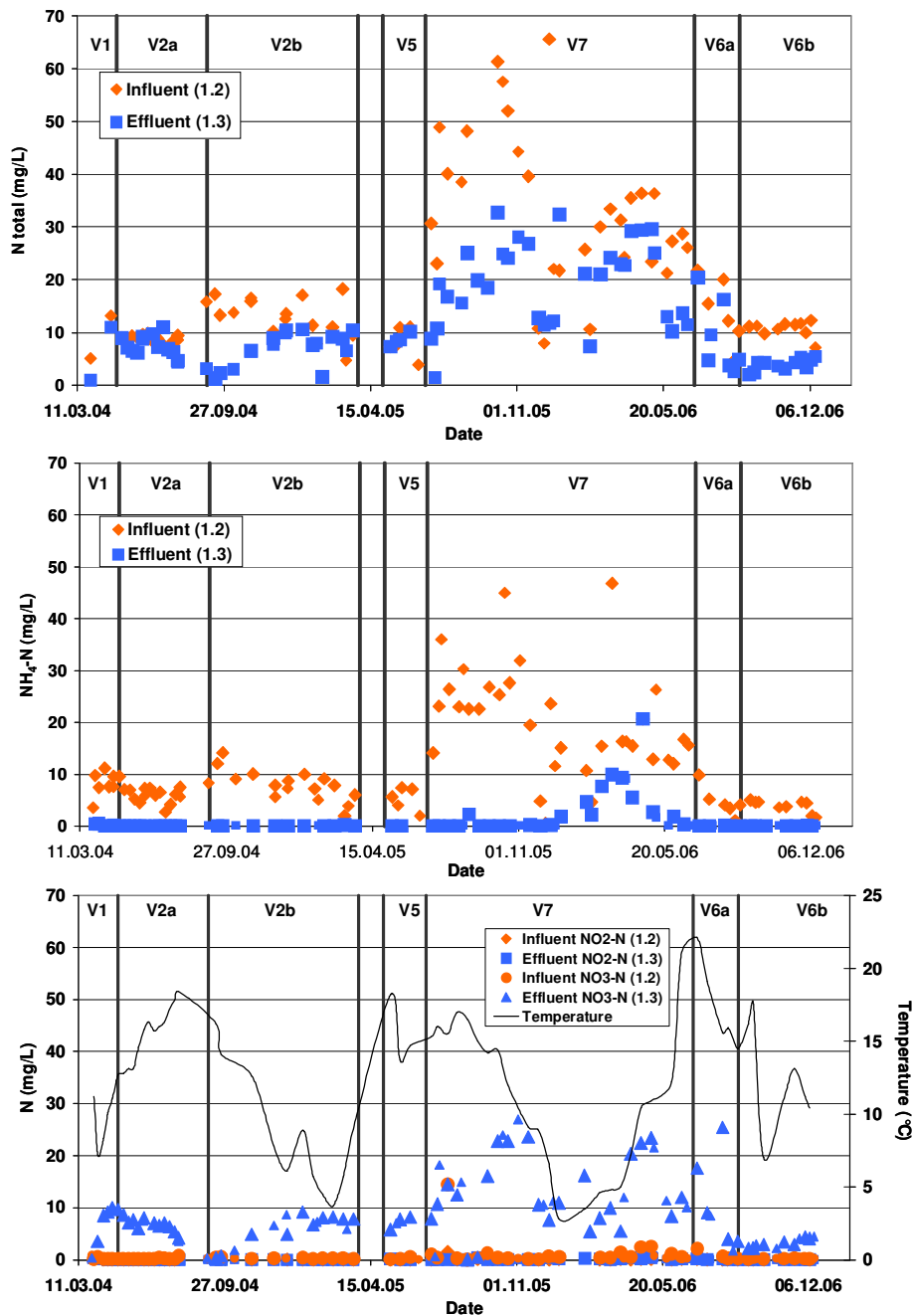

**Fig. 3.5.6.5:** Nitrogen parameters of the influent and effluent of the constructed wetland (24 h composite sample) (above: N-total; middle:  $\text{NH}_4\text{-N}$ ; below:  $\text{NO}_2$  and  $\text{NO}_3$ )

Compared to conventional wastewater, the nitrogen concentrations in the influent of the constructed wetland during *Variant V1* to *V5* are much lower, due to the urine separation. The concentration level was lower than 20 mg/L, the corresponding ammonia concentration was below 15 mg/L. These values show a leakage of nitrogen in the separation system. This was caused by a lower than assumed urine separation rate of the toilets (see chapter 3.6). During *Variant V7*, concentration levels went up significantly, when greywater from both buildings was mixed with faeces filtrate from brownwater from the apartment house.

Ammonia was nitrified throughout most of the operation time. The only time ammonia could be detected in the effluent was during the very cold winter of 2006. Most of the total nitrogen in the effluent of the constructed wetland was caused by nitrate as a product of the nitrification process. Denitrification took place even though there was an aerobic environment in the constructed wetland. Due to the mainly aerobic conditions in the filter, the denitrification of the oxidised nitrogen occurred only partially. In *Variant V7*, the nitrogen concentration in the influent rose significantly. Most of the time, however, it could not be nitrified completely. Due to the higher loading the nitrification rate increased only in winter times there was ammonia in the effluent. This higher nitrification rate could also be identified by the



higher nitrate concentrations in the effluent, which didn't cover the whole nitrogen input due to denitrification processes in the filter.

The influent and effluent concentrations of phosphorus are shown in **Fig. 3.5.6.6**.

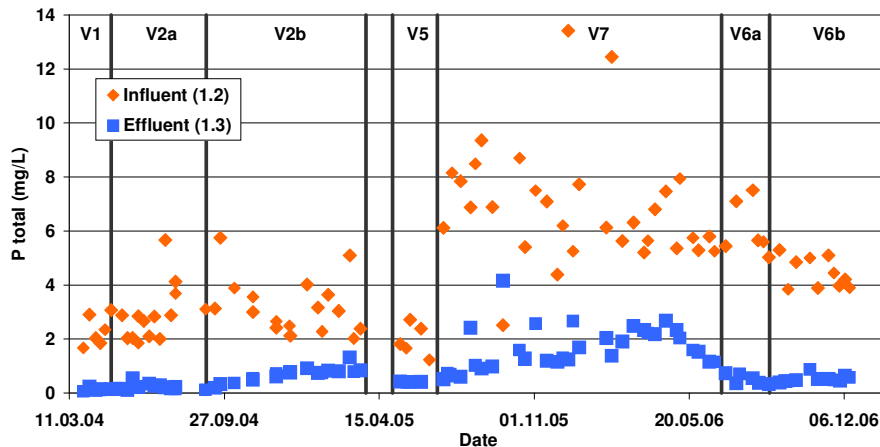

**Fig. 3.5.6.6:** Total phosphorus concentration of the influent and effluent of the constructed wetland (24 h composite sample)

The phosphorus concentration in the influent was between 2 mg/L and 4 mg/L during the *Variants V1* and *V5*. Later, it went up to approx. 8 mg/L. These concentrations were much higher than expected. The reason for this is mainly to be found in the use of the dishwasher, since detergents contain a high concentration of phosphates.

During the first two phases, the constructed wetland was able to bind the phosphorus with the filter sand and ferric particles, which were mixed to the filter material. The increase of the effluent concentration, starting in *Variant V2b*, may demarcate the beginning of a decreasing binding capacity. But the effluent concentration was decreasing again at the end of *Variant V7* when the influent concentration and load (see **Tab. 3.5.6.1**) was also decreasing. After the regeneration phase of the filter the phosphorus uptake increased again; this may be a hint that adsorption capacity still exists. The reason for the reactivating binding capacity could not be found.

The mean values of concentrations and loads for the different variants are listed in **Tab. 3.5.6.1**.

**Tab. 3.5.6.1:** Influent and effluent data of the constructed wetland (24 h composite sample, mean value)

Parameter	Symbol	Unit	Design value	V1	V2a	V2b	V5	V7	V6a	V6b
greywater from				office building	office building	office building	office building	both buildings	apartment house	both buildings
faeces filtrate				with	without	with	with	with	without	without
Variant duration				11.3.04 - 5.5.04	6.5.04 - 4.9.04	5.9.04 - 29.3.05	3.5.05 - 29.6.05	30.6.05 - 30.6.06	1.7.06 - 31.8.06	1.9.06 - 31.12.06
<b>Flowrates</b>										
Influent	$Q_0$	L/d	4.580	1.185	1.141	2.062	1.419	5.246	1.826	4.594
Effluent	$Q_e$	L/d		1.400	1.318	2.117	2.519	5.246	1.826	4.594
Hydraulic load	$B_{A,Q}$	mm/d	40	12	11	18	22	45	31	40
<b>Temperature</b>										
Influent	$T_0$	°C		12,6	17,6	10,9	17,3	12,3	16,0	13,6
Effluent	$T_e$	°C		10,1	15,6	7,8	15,5	10,7	17,4	12,4
<b>COD</b>										
Influent conc.	$COD_0$	mg/L		98	73	136	101	402	410	313
Effluent conc.	$COD_e$	mg/L		27	25	13	17	28	35	18
Load influent	$BCOD_0$	g/d		116	83	280	143	2.111	749	1.439
Load effluent	$BCOD_e$	g/d		38	33	28	43	145	64	82
Load Removal rate	$\eta_{COD}$	%		67	60	90	70	93	92	94
Specific load	$B_{A,COD}$	g/(m <sup>2</sup> .d)	20	1,00	0,72	2,42	1,24	18,20	12,91	12,40
<b>BOD<sub>5</sub></b>										
Influent conc.	$BOD_0$	mg/L		21	40	42	47	149	70	166
Effluent conc.	$BOD_e$	mg/L		4,0	3,0	3,0	2,0	3,7	3,4	17,3
Load influent	$BBOD_0$	g/d		24,9	45,6	86,6	66,7	782,2	127,8	762,6
Load effluent	$BBOD_e$	g/d		5,6	4,0	6,4	5,0	19,3	6,1	79,2
Load Removal rate	$\eta_{BOD}$	%		77	91	93	92	98	95	90
Specific load	$B_{A,BOD}$	g/(m <sup>2</sup> .d)	10	0,21	0,39	0,75	0,57	6,74	2,20	6,57
<b>Total Nitrogen</b>										
Influent conc.	$N_{tot,0}$	mgN/L		9,1	9,3	13,0	8,1	33,4	12,1	10,7
Effluent conc.	$N_{tot,e}$	mgN/L		6,0	6,7	7,1	8,6	19,6	8,9	4,0
Load influent	$BN_{tot,0}$	gN/d		10,8	10,6	26,8	11,5	175,4	22,1	49,3
Load effluent	$BN_{tot,e}$	gN/d		8,4	8,8	15,0	21,7	102,7	16,3	18,2
Load Removal rate	$\eta_{N_{tot}}$	%		22	17	44	-	41	26	63
Specific load	$B_{A,N}$	gN/(m <sup>2</sup> .d)		0,09	0,09	0,23	0,10	1,51	0,38	0,42
<b>Ammonia</b>										
Influent conc.	$NH_4N_0$	mgN/L		8,3	6,1	8,0	5,2	20,4	4,7	3,8
Effluent conc.	$NH_4N_e$	mgN/L		0,20	0,02	0,20	0,02	2,60	0,11	0,12
Load influent	$BNH_4N_0$	gN/d		9,8	7,0	16,5	7,4	106,9	8,5	17,6
Load effluent	$BNH_4N_e$	gN/d		0,28	0,03	0,42	0,05	13,66	0,20	0,55
<b>Org. Nitrogen</b>										
Influent conc.	$N_{org,0}$	mgN/L		2,9	2,9	4,8	2,6	13,8	8,8	6,5
Effluent conc.	$N_{org,e}$	mgN/L		0,9	1,0	1,4	0,9	4,7	1,3	0,9
Load influent	$BN_{org,0}$	gN/d		3,4	3,3	9,9	3,7	72,3	16,0	29,7
Load effluent	$BN_{org,e}$	gN/d		1,2	1,3	3,0	2,3	24,5	2,3	4,0
<b>Nitrate</b>										
Influent conc.	$NO_3N_0$	mgN/L		0,40	0,30	0,30	0,20	1,10	0,77	0,31
Effluent conc.	$NO_3N_e$	mgN/L		7,3	5,7	5,5	7,2	13,2	10,0	3,3
Load influent	$BNO_3N_0$	gN/d		0,5	0,3	0,6	0,3	5,8	1,4	1,4
Load effluent	$BNO_3N_e$	gN/d		10,2	7,5	11,6	18,1	69,1	18,2	15,0
<b>Nitrogen removal</b>										
Nitrified Nitrogen	$B_N$	gN/d			9,3	23,4	9,2	137,2	19,5	44,7
Nitrification rate	$\eta_N$	%			88	87	80	78	88	91
Denitrified Nitrogen	$B_{DN}$	gN/d			1,8	11,8	-	68,1	1,3	29,7
Denitrification rate	$\eta_{DN}$	%			19	50	-	50	7	66
<b>Total Phosphorus</b>										
Influent conc.	$P_{tot,0}$	mgP/L		2,0	2,9	3,2	1,9	6,9	6,1	4,5
Effluent conc.	$P_{tot,e}$	mgP/L		0,13	0,20	0,70	0,40	1,66	0,52	0,54
Load influent	$BP_{tot,0}$	gP/d		2,4	3,3	6,6	2,7	36,0	11,1	20,4
Load effluent	$BP_{tot,e}$	gP/d		0,2	0,3	1,5	1,0	8,7	0,9	2,5
Load Removal rate	$\eta_{P_{tot}}$	%		92	92	78	63	76	91	88
Volumetric load	$B_{A,P}$	gP/(m <sup>2</sup> .d)		0,02	0,03	0,06	0,02	0,31	0,19	0,18

In order to assess the nitrogen removal rate of the constructed wetland, the values were calculated as follows:

Nitrified Nitrogen	$BN_N$	=	$BN_{tot,0} - BN_{org,e} - BNH_4 N_e$	[g / d]
Denitrified Nitrogen	$BN_{DN}$	=	$BN_N - BNO_3 N_e$	[g / d]
Nitrification rate	$\eta_N$	=	$\frac{BN_N}{BN_{tot,0}}$	[%]
Denitrification rate	$\eta_{DN}$	=	$\frac{BN_{DN}}{BN_N}$	[%]

As the figures in **Tab. 3.5.6.1** show, the hydraulic load of the constructed wetland only corresponded to the targeted value during *Variant V6b*. During *Variant V7*, it was approx. 15 % higher. During all the other variants, the constructed wetland was considerably underloaded. The operation conditions with regard to the hydraulic load, as well as the specific COD load and influent composition (greywater from both buildings and faeces filtrate from brownwater from apartment house) during *Variant V7* suggest, that these loads were too high because, as a result, clogging occurred. This has already been mentioned at the beginning of this chapter. During most variants, the mean effluent temperature was approx. 2 °C lower than the influent temperature.

Aside from this, the COD effluent concentration of 28 mg/L was low compared to the concentrations of approx. 40 mg/L to 50 mg/L in the effluents of the Berliner wastewater treatment plants. The Ammonia values in the effluent show that nitrification took place at all times. The slightly higher value in *Variant V7* was related to the very cold winter in 2006. Even then denitrification took place, which led to respectable overall nitrogen removal rates of 41 % and 63 % for *Variant V7* and *V6b*, respectively. The phosphorus effluent concentrations were, for most variants, low; not so, however, for *Variant V7*. This may be linked to the fact that this was the highest influent load of all variants, as well as the fact that the phosphorus adsorption capacity at the iron sludge (see 2.4.10) and the filter sand of the constructed wetland was not high enough to result in a higher removal rate. In order to obtain a low effluent value, however, an additional phosphorus elimination step such as precipitation would have to be integrated anyway. For additional information on the phosphorus effluent concentrations during all variants, see also the description of **Fig. 3.5.6.6**.

In addition to the physical/chemical parameters, it is important to find out what the effluent quality of the constructed wetland concerning bacteriological parameters was. Results for total and faecal coliforms are given in **Fig. 3.5.6.7** and **Fig. 3.5.6.8**.

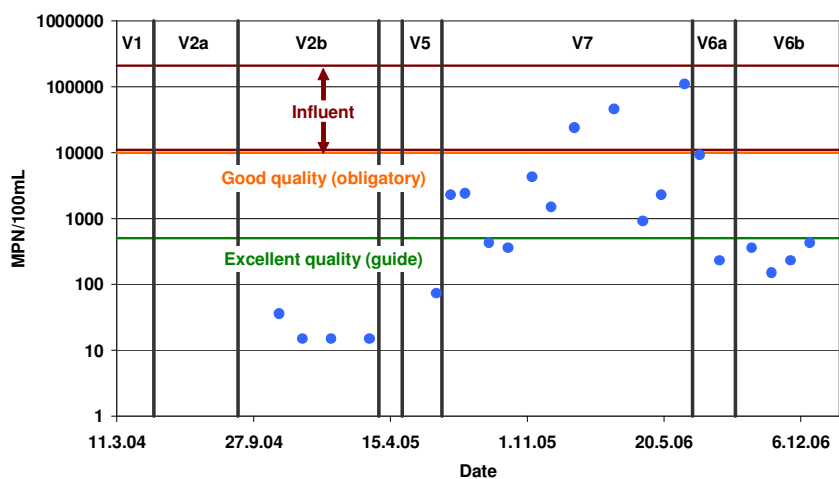

**Fig. 3.5.6.7:** Total coliforms in the influent and effluent of the constructed wetland



Due to the restricted HRT and SRT conditions, the sludge concentration was maintained in the approximate range of 10 gMLSS/L down to 3 gMLSS/L, which is a lower to medium range for MBR process. The reactor temperature was in the range 18-26°C during the duration of the trials, as a result of the usage of warm greywater, and the location of the pilot unit in a temperate room (18–23°C).

### 3.5.7.2 Greywater characterisation and comparison with literature values

The table below (**Tab. 3.5.7.2**) presents the mean composition of the greywater stored in the equalisation tank for the parameters pH, COD, SS, TN, NH<sub>4</sub>-N, TP and PO<sub>4</sub>-Pf, as well as the corresponding COD/N/P ratios over the several phases. These values are compared with the value chosen for the pilot design. The phase 5 is not represented because of its short duration.

**Tab. 3.5.7.2:** Greywater characterization over the different phases and comparison with design values

	unit	design values	overall trials	Phase 1	Phase 2	Phase 3	Phase 4
pH		-	-	7.6	7.6	7.9	7.9
COD	mgO <sub>2</sub> /L	440	333	398	481	369	277
SS	mg/L	120	200	83	48	100	251
TN	mgN/L	12	15	17.1	12.4	12.7	12
NH <sub>4</sub>	mgN/L	4.5	3.8	4.9	3.8	2.7	3.2
TP	mgP/L	8	6.1	6.8	4.4	6	4.8
PO <sub>4</sub> -Pf	mgP/L	7.6	4.3	5.42	3.9	3.6	3.6
COD/N/P	%	100/3/2	100/5/2	100/4/2	100/3/1	100/4/2	100/5/2

The investigated raw water showed relatively high concentrations of COD, TN and TP resulting from the collection of the kitchen wastewaters in the greywater. Ammonium ion represented only 20 – 25 % of total nitrogen, and total phosphorus consisted up to 60 – 80 % of phosphate. The significant organic nitrogen fraction can be partly accounted for by the presence of urea in the greywater, which did not have sufficient time to oxidise as ammonium ion in the short collection system.

The lack of nutrients for normal biological growth was considered to be a potential concern, especially for the operation with low sludge age and greater sludge yield. However the COD/N/P ratios appeared to be in a normal range for biogrowth and no lack of nutrients was expected even at 4d SRT. The greywater pH was in the range 7.5 - 8.5; except few excursions, and the mixed liquor pH reached usually 8 - 8.5.

After connection of the apartment buildings (29.6.05, during the phase 1) the load of the several parameters increased and the influent concentration during the overall trials for the parameters COD and TP was 25 % lower for greywater from the office building and apartments than expected (design values), see **Tab. 3.5.7.2**. The TN load was even by 25 % higher for the influent concentration than the design value. The maximal difference between the design values and the measured one appears for the suspended solids since the observed concentration is 67 % higher than the expected one.

### 3.5.7.3 Operational issues

The trials were performed to gather operation experience with the process operated under the selected conditions. The following observations could be reported:

- **Foaming:** foaming and bulking are frequently reported to be a concern for MBR applications. We expected particularly strong foaming with greywater. Surprisingly, this was most of the time not an issue. No foaming occurred during seeding (due to seeding with adapted sludge?), and strong foaming was monitored only after few events of membrane chemical cleaning and during the last trials phase with 4 d SRT. Only one event of sludge lost due to foaming was experienced, after a chemical cleaning at the start of the 4 d SRT period.
- **Equalisation tank:** the operation of the equalisation tank appeared to provide most of the operational problem. Despite the continuous mixing, the greywater settled quickly and formed within few days an anaerobic layer at the bottom of the equalisation tank. This layer could ultimately clog the sieve or the feeding system. This would be an issue to deal with in full scale applications. To be noted that the greywater samples were taken in the equalisation tank and before the sieve. Some monitored parameters such as COD or TS may therefore not be fully representative of the greywater entering the biological reactor. In the last months of the trials, the equalisation tank was

regularly cleaned to avoid unforeseen operation disturbance and to increase the representativeness of the greywater.

### 3.5.7.4 Sludge production

**Fig. 3.5.7.1** presents the total solids (TS) concentration monitored in the mixed liquor throughout the trials. Two periods with low TS (15.09 - 19.09.05 and 23.11 - 05.12.2005) correspond to operational troubles (failure of permeate pump with continuous operation of excess sludge pump, and lost of sludge due to foaming after module chemical cleaning). The excursion during the short 10 d SRT phase could not really be explained. It could be due to a variable raw water quality entering the biological reactor, perhaps as a result of non representative functioning of the equalisation tank and the sieve in the first weeks of the trials. The quick increased of sludge concentration prompted anyway the quick implementation of the trials phase with 6 d SRT.

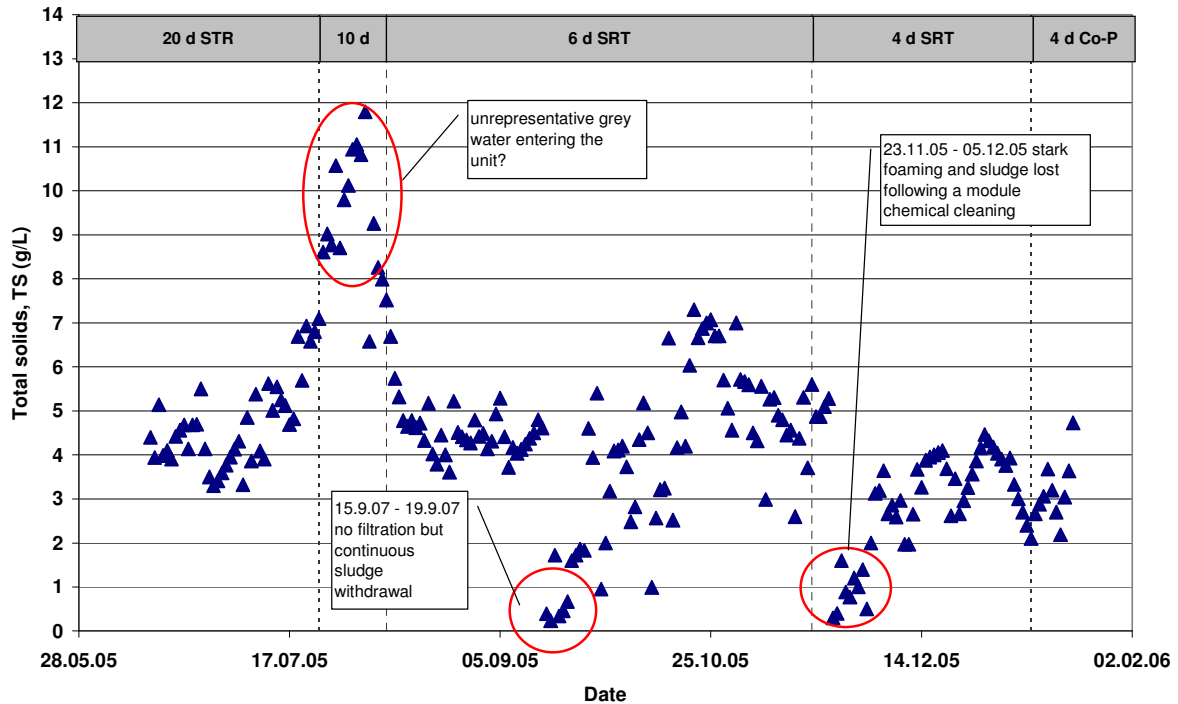

**Fig. 3.5.7.1:** TS in mixed liquor in greywater.

**Tab. 3.5.7.3** presents the calculation of sludge production yields for the different trials phases. Many aspects impacted the precision of these calculations, such as small plant size (35 L), variation of MLSS within one trials phase, measurement precision of MLSS, variation and representativeness of COD<sub>in</sub>, operational problems etc.. Therefore only rough calculations can be presented. In addition, only the two trials phases at 6 d and 4 d SRT were long enough to warrant the duration of 3 sludge age, usually considered in process engineering as required to achieve stable mass balances. Despite these considerations, the calculated sludge yields fitted well with common models of sludge production for the considered conditions. Relatively low sludge production was monitored due to the low TS/COD ratio of greywater. To be noted that the sludge yield doubles when reducing the sludge age from 20 d to 4 d SRT.

**Tab. 3.5.7.3:** Stabilised MLSS for respective phases and calculated sludge yields

SRT	Duration	Stabilised MLSS g/L	Sludge yield gMLSS/gCOD
20 d	30 d	3 - 7 (not stabil.)	~ 0.11
9 d	15 d	~ 10 (not stabil.)	~ 0.17
6 d	120 d	~ 5	~ 0.19
4 d	60 d	~ 3.5	~ 0.22
4 d + Co-P	10d	~ 4 (not stabil.)	~ 0.30

### 3.5.7.5 Carbon and nitrogen recovery

These results enable to compare the carbon and nitrogen recovery achieved by the MBR process for the two extreme sludge ages with the amount of carbon and nitrogen collected through the brown-water of the office building (Tab. 3.5.7.4). To calculate the nitrogen recovery, the nitrogen content of the biomass was considered to be 12 % whatever the operating conditions. The recovery of carbon and nitrogen with the greywater MBR operated at 4d SRT is estimated to be respectively + 14 % and + 40 % of the recovery achieved with the faecal matters only. This is not negligible, and can be compared with no recovery possible at all in the case of the artificial wetland. This emphasises the possibility to increase the greywater sludge production, with an MBR plant operated at low sludge age, in order to improve carbon and nitrogen recovery (as biogas production, or use as fertiliser or organic amendment). The MBR technology appears therefore to be an intensive technology which enables further nitrogen and carbon recovery.

Tab. 3.5.7.4: C- and N-recovery with MBR units operated at 4 and 20 d SRT (calculated for 50 e.p.)

	Brownwater office building	Greywater MBR			
		4d SRT		20d SRT	
	load (g/d)	load (g/d)	additional recovery	load (g/d)	additional recovery
Carbon	2,250	300	14%	150	7%
Nitrogen	95	36	40%	18	20%

### 3.5.7.6 COD elimination

Despite the low HRT of 2 h, the COD elimination was good and greater than 85 %, even with the low SRT of 4d (Fig. 3.5.7.2). Over the trials duration, an average value of 34 mgO<sub>2</sub>/L was monitored in the MBR permeate. This is to be compared with about 43 mgO<sub>2</sub>/L measured in the effluent of the Berlin WWTPs, and about 35 mgO<sub>2</sub>/L obtained in the permeate of MBR pilot units operated in Berlin with the municipal wastewater. This is in any case below the guidelines of 50 mgO<sub>2</sub>/L set up in Berlin for discharge of treated wastewater in the water bodies.

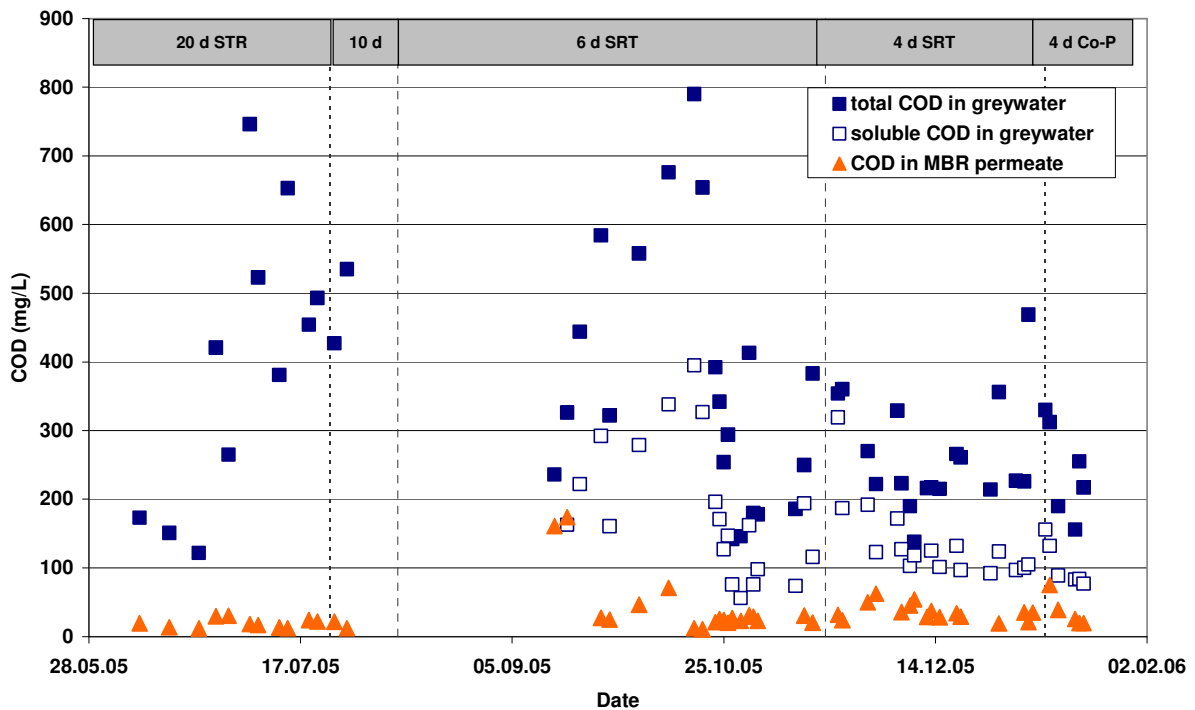

Fig. 3.5.7.2: COD concentrations in greywater and in MBR permeate.

### 3.5.7.6 Nitrogen elimination

The total nitrogen in the greywater consisted for 20 – 25 % of ammonium ion, and for 75 – 80 % of organic nitrogen compounds such as urea. The MBR permeate was however almost devoid of ammonia and organic nitrogen ( $\text{NH}_4 = 1.1 \text{ mgN/L}$ ) (**Fig. 3.5.7.3**). It can be therefore concluded that the consecutive processes of ammonification and nitrification were complete ( $> 80\%$  TKN-removal), even with the lower sludge age. Ammonification is known to be a quick reaction, but the good performance of nitrification is more unusual at low SRT. This resulted probably from the high temperature in the biological reactor (18 – 26 °C).

Nitrogen removal was inconstant and ranged from 20 to 80 % (in average 60 % and  $\text{TN} = 6.7 \text{ mgN/L}$  in MBR permeate, much below the local guideline for treated water discharge in waterbodies of 18 mgN/L), due mainly to the presence of nitrate in the permeate. Indeed, the main elimination mechanism was bioassimilation for cell growth, and therefore the removal rate depended strongly on the greywater characteristics (both COD and TN).

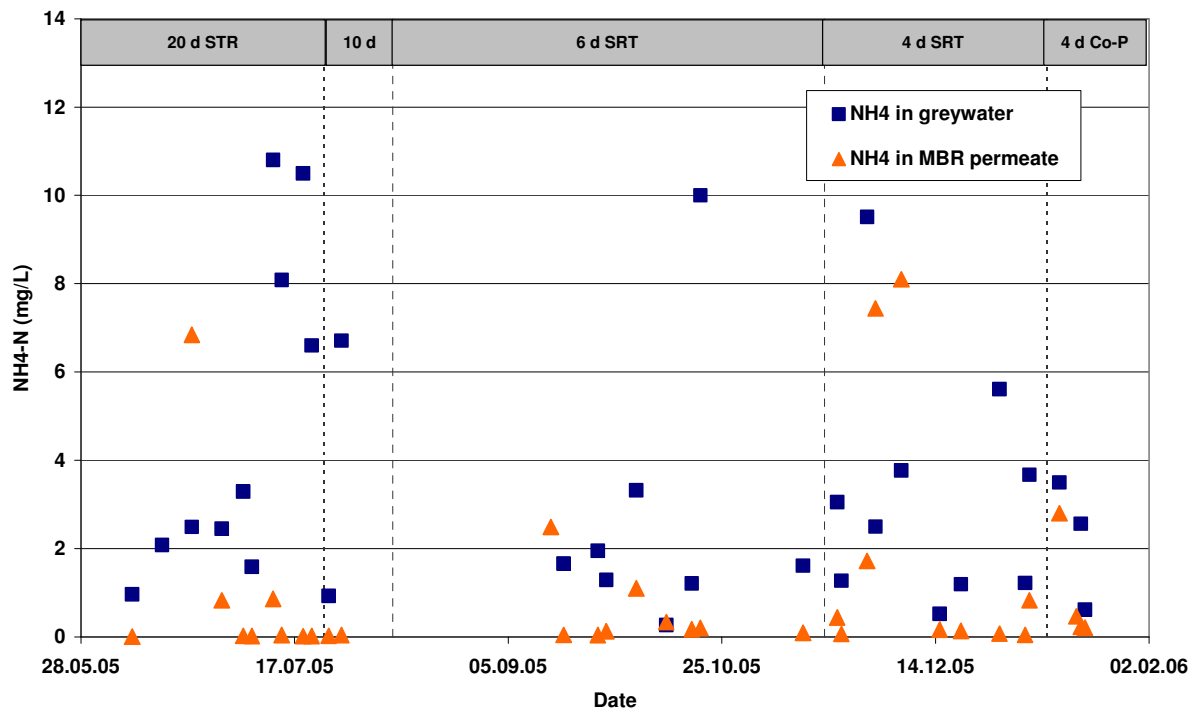
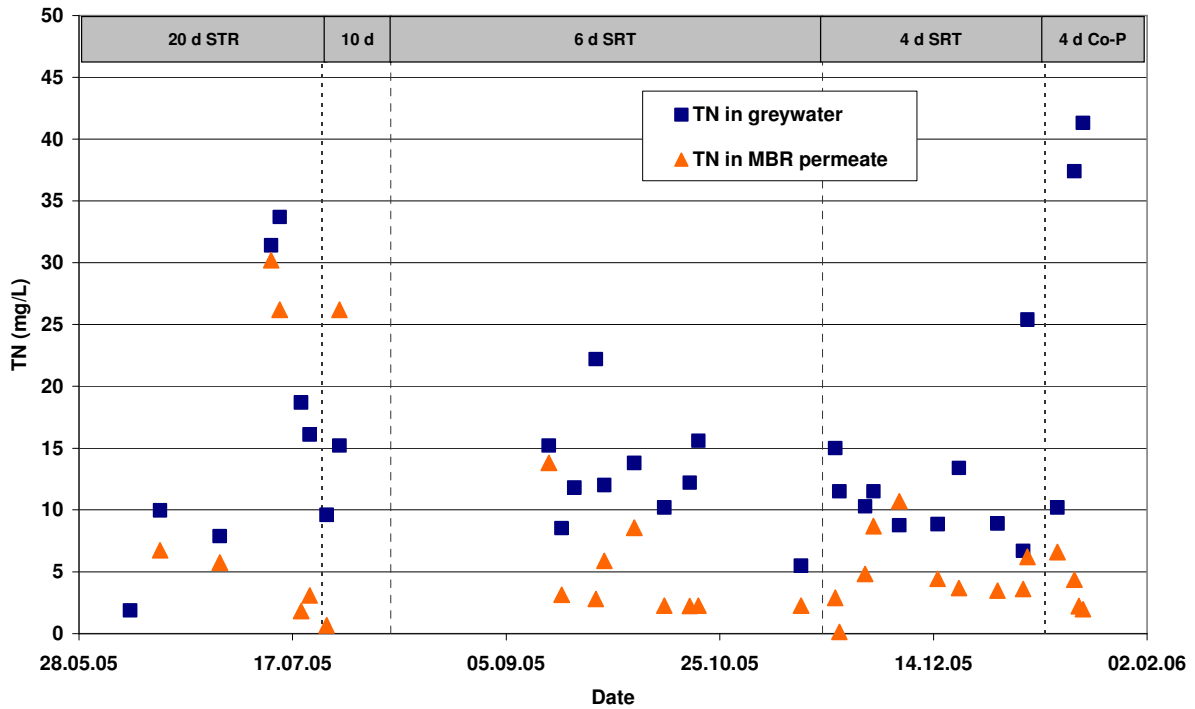

Fig. 3.5.7.3:  $\text{NH}_4$  concentrations in greywater and in MBR permeate.





**Fig. 3.5.7.4.:** TN concentrations in greywater and in MBR permeate.

Due to the importance of ammonification and bioassimilation, exact nitrification rates could not be determined in situ (for example through daily profiles), and standard batch tests with  $\text{NH}_4$ -spike were not performed. A range of nitrification rates could be however estimated with the results of the trials, as presented in **Tab 3.5.7.4**: the maximal possible nitrification rate was calculated, considering complete ammonification into  $\text{NH}_4$ , and no  $\text{NH}_4$  elimination through biogrowth. The minimal possible nitrification rate was calculated with the same assumptions, and the additional hypothesis that the produced biomass consists for 12 % of nitrogen, originating in totality from the dissolved ammonia. They appeared to be quite low when compared with nitrification rates measured in conventional activated sludge plant with municipal wastewater (typically 2 to 5  $\text{mgN/gVSS.h}$ ). In addition, the expected reduction of nitrification rates at low SRT was not observed.

**Tab. 3.5.7.5:** Minimum nitrification rates estimated for different trials phases

SRT	Stabilised MLSS	Maximum nitrification rates
	g/L	$\text{mgN/gVSS.h}$
9 d	~ 10	0.7 - 1.5
6 d	~5	1.5 – 4.2
4 d	~3.5	2.25 – 3.3

### 3.5.7.7 Phosphorus elimination

**Fig. 3.5.7.5** presents the results for total phosphorus. Similar to nitrogen fraction, most of organic phosphorus was turned into phosphate, which was then assimilated for biogrowth. About 50 % of total phosphorus could be removed, depending on the COD/P ratio of the greywater. The total phosphorus concentration in the MBR permeate was in average 3  $\text{mgP/L}$ , which is above the local guideline for treated water discharge in water bodies set up at 1  $\text{mgP/L}$ . However this value can be easily achieved, as expected, with slight co-precipitation (low dosing rate of  $\beta = 2$ ). This was demonstrated in the 10 last days of the trials with addition of ferric chloride.

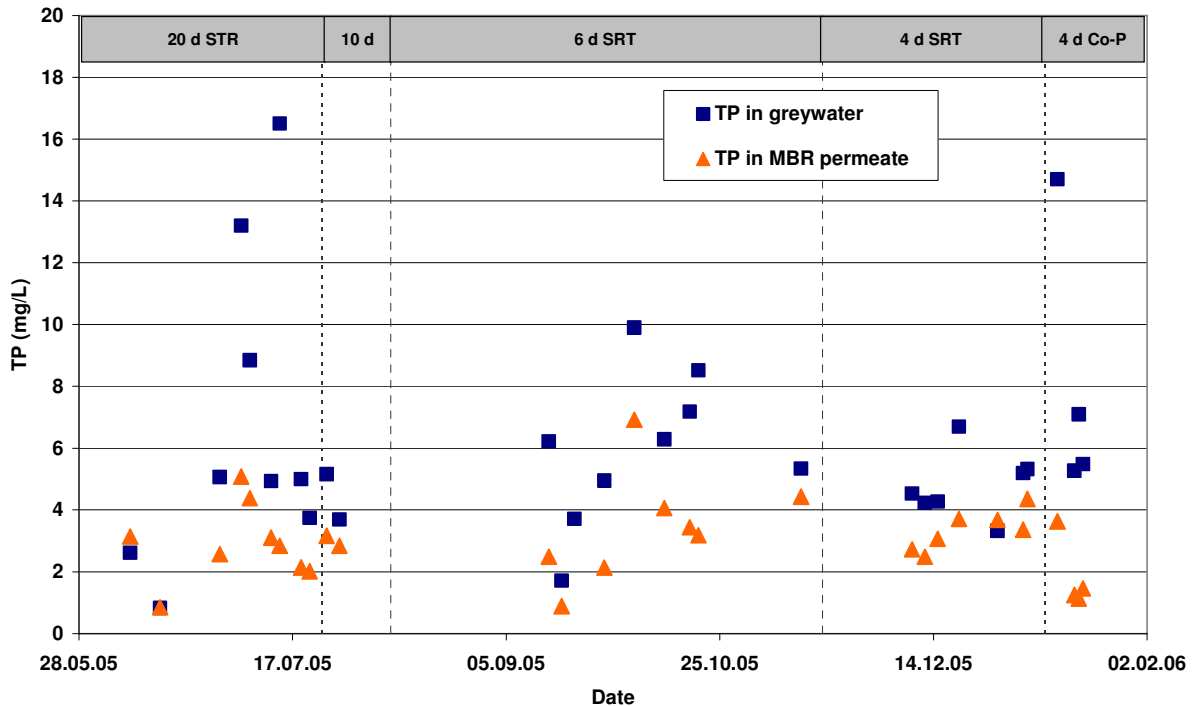

Fig 3.5.7.5: TP concentrations in greywater and in MBR permeate

### 3.5.7.8 Disinfection

Eight MBR permeate samples were collected and analysed for bacteriological parameters. *E. Coli.*, *Tot. Coli.* and *Faecal Coli.* were always below the detection limit, and the virus parameter was always monitored at 0pfu/100mL. Only one sample showed positive values, probably due to contamination during sampling.

### 3.5.7.9 Filtration performance

The flat sheet membrane module provided by the company A3 water solution (Gelsenkirchen, Germany) could be operated continuously over the 8 months of the trials under a filtration / pause regime with a net flux of about 8 L/h.m<sup>2</sup> and chemical cleanings performed on a monthly basis as few hours soaking and filtration in a chlorine solution. This low flow cannot be accounted for by the filterability of the sludge (very low levels of polysaccharides and proteins, most of the time below the detection limit, were monitored in the sludge supernatant). This can be better explained by the obsolete filtration technology implemented in these trials. The company A3 water solutions do not market anymore this technology. The authors anticipate that their new product, or other MBR filtration systems available in the market, would achieve a net filtration flux of 15-20 L/h.m<sup>2</sup> with the type of mixed liquor maintained in the reactor.

### 3.5.7.9 Comparison of MBR and constructed wetland processes

As the MBR pilot unit was operated side-by-side with an constructed wetland, it is possible to compare the performances of the two processes, and to discuss the respective advantages and drawbacks of the two systems. This is synthesised in **Tab. 3.5.7.6**, where the design and operation parameters were calculated or estimated for the actual capacity of the demonstration site, i.e. for 50 e.p., which corresponds to a throughflow of about 5 m<sup>3</sup>/d of greywater. The analysis shows that despite its extreme compactness (2 m<sup>3</sup> reactors versus 116 m<sup>2</sup> constructed wetlands), the main advantage lies in the potential for unrestricted water reuse, for example as toilet flushing, and additional biosolids or nitrogen recovery for soil amendment. The advantage of biogas recovery may be modulated given the size of such applications (not adapted for large sewer systems), and given the energy requirement of the MBR plants. The total energy balance would favour the passive wetlands system which does not need much energy even though it does not permit carbon recovery. The required manpower for the two

systems depends strongly on the level of automation of the plants, and the local organisation (implication of residents, cleaning strategy etc). The ratio "manpower per capita" will go down for installations of larger capacity.

**Tab. 3.5.7.6:** Advantages and drawbacks of the MBR technology versus constructed wetland.

For 50 e.p. ~ 5 m <sup>3</sup> /d	MBR low SRT (4d SRT)	MBR medium SRT (20d SRT)	Constructed wetland
Size	buffer: 1.6 m <sup>3</sup>	buffer: 1.6 m <sup>3</sup>	septic tank: 1 m <sup>3</sup>
	reactor: 0.4 m <sup>3</sup> (TS ~ 4-6 g/L)	reactor: 0.4 m <sup>3</sup> (TS ~ 10-15 g/L)	constructed wetland: 116 m <sup>2</sup>
Discharge (irrigation reuse)	Yes	Yes	Yes
Disinfection (irrestricted reuse)	Yes	Yes	No
Additional biosolids / ~biogaz production	+14%	+7%	0
Additional N-value (fertiliser in biosolids)	+40%	+20%	0
Energy (without biogas recovery)	0.4 – 0.8 kWh/m <sup>3</sup>	0.5 – 0.9 kWh/m <sup>3</sup>	~ 0 kWh/m <sup>3</sup>
Manpower	1-5 day / month	1-5 day / month	2-10 day / year

### 3.5.7.10 Comparison of MBR and constructed wetland treatment performances

**Tab. 3.5.7.7** presents a comparison of the treatment performance of the two treatment processes: the constructed wetland and the MBR. The presented influent and effluent values are in both cases mean values from the several measurements made during the periods. The elimination rate was calculated from the mean influent and effluent values. The two units were fed with equivalent row water (*Variant V6b* and phase 3): only greywater from office building and apartment house (see chapter 2.3).

In both cases the COD was well eliminated (94 % for the constructed wetland and 93 % for the MBR), the nitrification was complete (97 % of ammonium elimination for the constructed wetland and 95 % for the MBR). The denitrification is also comparable with a total nitrogen elimination of 63 % for the constructed wetland and 62 % for the MBR. Since the two treatment facilities were not designed to perform a denitrification, it could be assumed that this elimination of the total nitrogen is due a comparable bio-assimilation mechanism.

The P-removal in the MBR is probably due to the growth cell requirement and achieves 42 % elimination. The P-removal in the constructed wetland is essentially due to an adsorption on the sands and ferric particles which are incorporated in the filter material. This removal phenomenon shows a better removal performance since 88 % of the influent total phosphorus was eliminated in the constructed wetland. Nevertheless this elimination will decrease after a long term operation (see chapter 3.5.6).

This comparison does not show a significant variation of treatment performance between the two processes except for the P-removal and the disinfection (see above).

**Tab. 3.5.7.7:** Comparison of MBR and constructed wetland treatment performances

		constructed wetland			MBR		
variant duration		121 d (V6b)			100 d		
process characterization		Hydraulic load: 40 mm/d			SRT: 6 d		
parameter	unit	influent	effluent	elimination (%)	influent	effluent	elimination (%)
COD	mgO <sub>2</sub> /L	313	18	94	348	25	93
N total	mgN/L	10.72	3.96	63	12.70	4.80	62
NH <sub>4</sub> -N	mgN/L	3.83	0.12	97	2.66	0.14	95
NO <sub>3</sub> -N	mgN/L	0.31	3.26	-	0.26	2.81	-
NO <sub>2</sub> -N	mgN/L	0.06	0.03	47	0.51	0.17	67
PT	mgP/L	4.45	0.54	88	5.98	3.44	42
PO <sub>4</sub> -Pf	mgP/L	3.74	0.58	84	3.61	3.19	12

**3.5.7.11 Conclusions for MBR issues**

This study was conducted to assess the treatment performance of the MBR process treating grey-water, and to compare it with a constructed wetland operated side-by-side. The MBR unit was operated under conditions of low HRT (2 h) and low SRT (20 d down to 4 d). The concept of low SRT was to reduce investment and operation costs while increasing the sludge production, therefore optimising C- and N-recovery, in adequation with the overall goal of the new sanitation concepts.

The MBR process showed excellent treatment performances under all tested conditions, even at low SRT. COD-elimination was beyond 85 %, complete ammonification and nitrification was observed, leading to about 60 % N-removal (6.7 mgN/L without denitrification zone in the MBR permeate), and about 50 % P-removal due to biogrowth only. The measurement of the sludge production fit the available models, whereby about twice as much sludge was produced at 4d compared with 20d SRT. The implementation of the low SRT MBR to treat greywater would lead to + 14 % and + 40 % of respectively carbon and nitrogen recovery in the overall balance of the tested concept.

MBR technology provides a much more compact treatment than artificial wetlands, as well as greater potential for water, nutrients and carbon recovery. However they are associated with high operation costs, due to mainly high energy and maintenance costs.

**3.5.8 Biogas plant**

An overview of the operation of the biogas plant is given in **Fig. 3.5.8.1**.

		July	August	September	October	November	December
<b>plant start-up</b>	low load manual feeding without bio-waste without settling	45d					
<b>variant V1a</b>	low load manual feeding without bio-waste without settling		25d				
<b>variant V1b</b>	normal load automatic feeding without bio-waste without settling			50d			
<b>variant V2a</b>	normal load automatic feeding without bio-waste with settling					34d	
<b>variant V2b</b>	normal load automatic feeding with bio-waste with settling						27d

**Fig. 3.5.8.1:** Overview of the operation of the biogas plant

In order to start the operation, the biogas plant was filled with thermophile sludge from a thermophile biogas plant near Berlin. After it had been filled, brownwater from the vacuum plant was pumped to the biogas plant. The volume was increased step by step until the operation was stable. The filling operation was undertaken manually twice a day from Monday to Friday. After the start-up phase, *Variant V1a* was started with the same feeding procedure. For *Variant V1b*, the brownwater was pumped to the biogas plant automatically. For each feeding, about 10 L of brownwater were pumped to the plant. Beginning with the operation of *Variant V2a*, the brownwater was thickened before it was pumped into the biogas reactor automatically. This was done in the balance tank of the biogas plant (see chapter 2.4.11). In *Variant V2b*, the same feeding procedure was used, but grinded bio-waste from tenants of the apartment house was added. The most interesting results of the tested variants are listed in **Tab. 3.5.8.1**.

**Tab. 3.5.8.1:** Results (mean values) of the operation of the biogas plant for the four tested variants

		unit	V1a	V1b	V2a	V2b
	period duration		3.7.06 - 17.8.06	18.8.06 - 11.9.06	12.9.06 - 30.10.06	31.10.06 - 31.12.06
operational parameters	inflow	L/d	15	54	44	40
	addition of bio-waste	g/d				600
	HRT	d	20,5	5,5	6,8	7,5
	temperature	°C	55	55	55	55
	overflow buffer/sedimentation tank	L/d			26	22
biogas	biogas production	L/d	43	75	122	130
	CH <sub>4</sub> content in biogas M6000	%	47	44	49	44
	CH <sub>4</sub> production	L <sub>CH<sub>4</sub></sub> /d	20	33	59	57
COD	COD concentration influent	mg/L	7.627	7.627	9.743	9.023
	COD load influent	g/d	111	413	429	363
	COD load degraded	g/d	47	273	309	249
	COD degraded	%	42	66	72	69
	COD loading	g/m <sup>3</sup> .d	371	1.378	1.429	1.209
	spec. CH <sub>4</sub> production (COD input)	L <sub>CH<sub>4</sub></sub> /kg <sub>COD</sub>	181	80	139	158
	spec. CH <sub>4</sub> production (COD degraded)	L <sub>CH<sub>4</sub></sub> /kg <sub>COD</sub>	429	121	193	231
	spec. biogas production (COD input)	L <sub>biogas</sub> /kg <sub>COD</sub>	385	182	285	357
	spec.biogas production (COD degraded)	L <sub>biogas</sub> /kg <sub>COD</sub>	913	276	396	521
vDR	vDR concentration influent	g/kg	3,53	3,53	4,28	4,21
	vDR load influent	g/d	51	191	188	169
	vDR load degraded	g/d	11	93	114	105
	vDR degraded	%	21	49	60	62
	vDR loading	g/m <sup>3</sup> .d	172	637	628	564
	spec. CH <sub>4</sub> production (vDR input)	L <sub>CH<sub>4</sub></sub> /kg <sub>vDR</sub>	391	173	316	339
	spec. CH <sub>4</sub> production (vDR degraded)	L <sub>CH<sub>4</sub></sub> /kg <sub>vDR</sub>	1.901	353	524	546
	spec. biogas production (vDR input)	L <sub>biogas</sub> /kg <sub>vDR</sub>	832	394	650	765
	spec.biogas production (vDR degraded)	L <sub>biogas</sub> /kg <sub>vDR</sub>	4.045	806	1.077	1.234
	influent concentration rate COD/vDR	g <sub>COD</sub> /g <sub>vDR</sub>	2,16	2,16	2,28	2,14
DR	DR concentration influent	g/kg	4,58	4,58	5,37	5,21
	DR load influent	g/d	67	248	236	209
	DR load degraded	g/d	11	85	131	113
	DR degraded	%	17	34	55	54
	DR loading	g/m <sup>3</sup> .d	223	826	788	698
	spec. CH <sub>4</sub> production (DR input)	L <sub>CH<sub>4</sub></sub> /kg <sub>DR</sub>	301	133	252	274
	spec. CH <sub>4</sub> production (DR degraded)	L <sub>CH<sub>4</sub></sub> /kg <sub>DR</sub>	1.779	386	455	507
	spec. biogas production (DR input)	L <sub>biogas</sub> /kg <sub>DR</sub>	641	304	518	618
	spec.biogas production (DR degraded)	L <sub>biogas</sub> /kg <sub>DR</sub>	3.784	883	936	1.146
	influent concentration rate vDR/DR	g <sub>vDR</sub> /g <sub>DR</sub>	0,77	0,77	0,80	0,81

For all variants, the operation temperature was approx. 55 °C. The influent volume was between 15 L/d and 54 L/d. *Variant V1a* was not operated with all the available brownwater from the vacuum plant. This led to a hydraulic retention time (HRT) of 20.5 d. The HRT between 5.5 d and 7.5 d was much shorter for the other variants. These retention times were in accordance with the expected retention time, which was estimated to be below 10 d. The bio-waste added during *Variant V2b* weighed 600 g/d. Unfortunately, for the bio-waste, no reliable COD values could be established. The thickening of the brownwater for *Variant V2a* and *V2b* led to approx. 30 % higher COD influent concentrations. Surprisingly, in *Variant V2b* (with bio-waste), the COD concentration and load were lower than in *Variant V2a* (without bio-waste). The reason for this may have been a lower COD load of the brownwater during the former variant (i.e. *V2b*).

Looking at the COD/vDR ratio, the values from all three variants were within the range of values for grease, which is about 2.5 (Lützner and Kühn 2000). The COD/vDR ratio for mixed sludge from WWTP is about 1.7. The specific COD gas production was below the stoichiometric value of  $0.35 \text{ Nm}^3 \text{ CH}_4/\text{kg COD degraded}$  (Lützner and Kühn 2000), apart from the value of *Variant V1a*, which is not a realistic value. When analysing the gas production in relation to volatile dry residue (vDR), it has to be stated that the productions during *Variant V2a* and *V2b* were within the range of values for mixed sludge from WWTP's, which is between  $0.5$  and  $0.6 \text{ Nm}^3 \text{ CH}_4/\text{kg vDR degraded}$  (Lützner and Kühn 2000). The value from *Variant V1a* is again unrealistic. The values for vDR degradation of 60 % and 62 % for *Variant V2a* and *V2b*, respectively, seem very high. But that high degradation seems possible for sludge from primary sedimentation tanks of WWTP's, using a mesophile digestion process (Lützner and Kühn 2000).

The results of specific  $\text{CH}_4$  production from *Variant V1b*, *V2a* and *V2b* in relation to COD, vDR and DR degraded is also shown in **Fig. 3.5.8.2**.

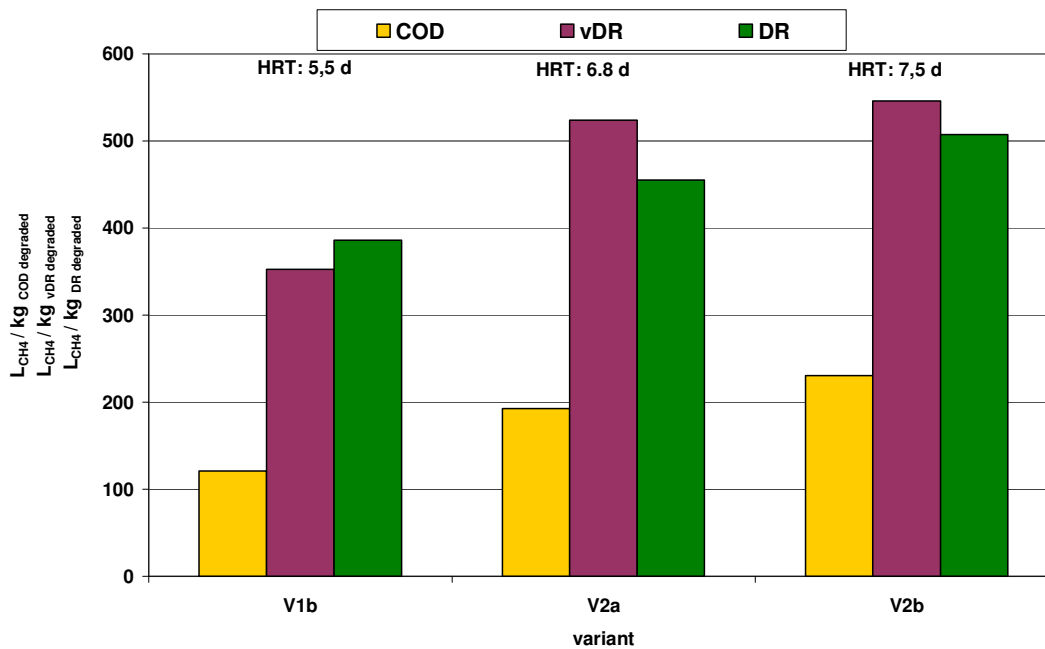

**Fig. 3.5.8.2:** Specific  $\text{CH}_4$  production (mean values) from *Variant V1b*, *V2a* and *V2b* in relation to COD, vDR and DR degraded

This figure shows that the specific  $\text{CH}_4$  production in relation to all three parameters increased from variant to variant. The main reason for that may have been the increase in the hydraulic retention time from 5.5 to 7.5 days. It seems that 5.5 days are not enough to produce large quantities of gas. But a hydraulic retention time of < 10 days still seems realistic for this thermophile digestion process.

It is noticeable that the  $\text{CH}_4$  content of 44 % to 49 % for the four variants is low compared to common values of approx. 65 % for biogas from municipal WWTP's. But the  $\text{CH}_4$  content depends very much on the substrate used for digestion.

In general, the operation of this biogas plant showed that the testing time was too short to obtain reliable results. Thus, the results presented here are just a first insight. In order to get more reliable results, it would be necessary to extend the time period of the operation.

### 3.6 Assessment of source separation

#### 3.6.1 General

The assessment of the effectiveness of the separation in the context of the tested sanitation concepts was undertaken for the different flows (yellow-, brown-, and greywater) that were discharged from the office building and the apartment house.

### 3.6.2 Office building

Due to different analysing procedures, balances were not calculated for all variants. Mass balances for the flows of the office building were calculated as follows:

- the values for urine (yellowwater) are mean values of the urine collected and analysed in the tanks during the whole period of *Variant V1 to V7*; period *V7* was taken into account up to the time when the apartment building was connected to the facilities;
- for the brownwater, the values were based on the period with the longest testing time with more than one gravity toilet (*V2b*);
- representative greywater values were available only starting with *Variant V5*, which was used for calculating the balances;

Applying these conditions will result in differences in volume and mass balances, but these can be discarded as negligible. Yellow-, brown- and greywater numbers linked to these volume and mass balances are listed in **Tab. 3.6.1**.

**Tab. 3.6.1:** Volume and mass balances of different parameters of yellow-, brown- and greywater from the office building (data basis: see text above)

		yellowwater (urine)	brownwater (faeces)	greywater	sum	feaces filtrate	difference brownwater feaces filtrate	sum substances for fertiliser	max. sum substances for fertiliser
		A	B	C	D	E	F = B - E	G = A + F	H = A + B
variant		V1 to V7	V2b	V5		V2b			
volume	L/d	7	169	1.419	1.594	168	1		
COD	g O <sub>2</sub> /d	58	805	268	1.130	170	635	693	863
N-total	g N/d	28	26	13	67	12	15	42	54
NH <sub>4</sub> -N	g N/d	26	4,0	0,6	31	4	0	26	30
Norg	g N/d	1,4	22,4	12	36	8	15	16	24
P-total	g P/d	2,9	6,8	2,9	12,6	3,4	3,4	6,3	10
K	g/d	15	*	10,8		*			
volume	%	0,4	10,6	89	100	10,5			
COD	%	5,1 (12)	71,2 (47)	23,7 (41)	100	15	56,2 (47)	61,2 (59)	76,3 (59)
N-total	%	41,3 (87)	39,5 (10)	19,2 (3)	100	17,7	21,8 (10)	63,1 (97)	80,8 (97)
NH <sub>4</sub> -N	%	85,1	12,9	2	100	14,1	0	84	98
N org	%	4	63,9	33	100	21,2	41,8	45,8	67
P-total	%	22,8 (50)	54,1 (40)	23,1 (10)	100	27	27,1 (40)	49,9 (90)	76,9 (90)

( ) literature value (Otterpohl, 2000) \* not analysed

Before starting to calculate the balances, it had to be considered how the office building was being used: Most likely, most people preferred to use their toilet at home for defecation. Greywater was mainly produced in the showers and the hand washing basins. Greywater volume produced by cooking and food cleaning was going to be very small due to the fact that the building was used mainly as a workspace.

As the table shows, the volume of yellowwater is very low compared to the other two flows. Brownwater, which mainly consisted of flushing water, makes up only approx. 10.6 % of the total volume. A better understanding of the numbers from columns A to C in this table is possible in **Fig. 3.6.1**.

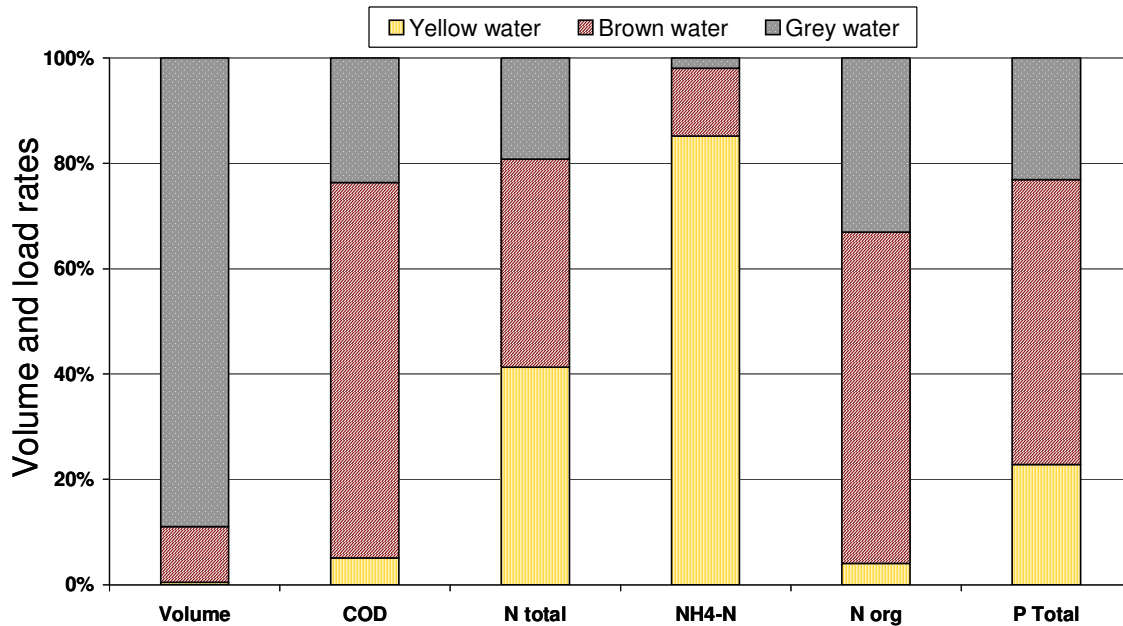

**Fig. 3.6.1:** Volume and mass balances of different parameters of yellow-, brown- and greywater from the office building (data basis: yellowwater: *Variant V1 to V7*; brownwater: *Variant V2b*; greywater: *Variant V5*)

Most of the organic substances (carbon source as COD) were found in the brownwater. Nitrogen was distributed nearly evenly between brown- and yellowwater. While yellowwater contained nitrogen in the form of ammonium (85.1%  $\text{NH}_4\text{-N}$ ), the brownwater was loaded mainly with organic nitrogen (63.9%). Regarding the distribution of phosphorus, in the urine, surprisingly small loads were found. The largest quantity was found in brownwater (54.1%).

When comparing the distribution rates with values given in the literature (see values in brackets), great differences become obvious: Concerning the brown- and greywater, higher charging rates than the ones documented in the literature were found, whereas concerning the urine the rates were lower than the ones documented in the literature.

In order to use the nutrients as fertiliser or fertilising products after the flows were being treated, different calculations with the figures in the columns E to H from **Tab. 3.6.1** were made. In addition to the flows of urine (column A) and greywater (column C), the brownwater (column B) was separated in the liquid phase, passing the faeces separator as filtrate (column E), and the solid phase (column F), being held back by the separator. During the testing periods used for this evaluation, the filtrate (column E) was mixed with the greywater and then treated in the constructed wetland.

Utilising the urine (column A) and the eliminated solids from the faeces (column F), approximately 61 % (literature 59 %) of COD, 63 % (literature 97 %) of N-total, and approx. 50 % (literature 90 %) of P-total from the total charge in all three waters (yellow, brown and grey) was available for the fertiliser or fertiliser production (column G). If the faeces filtrate could also have been used for fertilising, the utilisation rate would have been significantly higher, namely approximately 76 % for COD, 81 % for N-total, and 77 % for P-total (see column H).

This determining of volume and mass balance of urine, brown- and greywater from the office building was undertaken mainly when gravity separation toilets were tested there. No balance was calculated/established when vacuum separation toilets were used. This was based on the assumption that this would not bring new results, since these toilets were simply altered gravity separation toilets (see 2.4.1).

In spite of the high elimination rates of the faeces separator, nutrients were leaving the system and could, consequently, not be used for fertilisation. Thus, the faeces separation needs to be improved in order to obtain a higher amount of substances for fertilisation.



### 3.6.3 Apartment house

Like in the case of the office building, mass balances could not be calculated for all variants of the apartment house. They were determined as follows:

- the values for urine (yellowwater) are mean values of the urine collected from the urine pits during *Variant V6b*;
- the values for brownwater are mean values of the brownwater collected from the brownwater pits during *Variant V7*;
- the values for greywater are mean values of the greywater collected from the greywater pits during *Variant V7*.

As already mentioned in the case of the office building, slight differences in volume and mass balances will occur due to the different conditions, but, as above, they can be considered negligible. The results of the calculations are shown in **Tab. 3.6.2**.

**Tab. 3.6.2:** Volume and mass balances of different parameters of yellow-, brown- and greywater from the apartment house (data basis: see text above)

		yellowwater (urine)	brownwater (faeces)	greywater	sum	faeces filtrate	difference faeces faeces filtrate	sum substances for fertiliser	max. sum substances for fertiliser
		A	B	C	D	E	F = B - E	G = A + F	H = A + B
variant		V6b	V7	V7		V7			
volume	L/d	59	945	2.018	3.022	943	2		
COD	g O <sub>2</sub> /d	154	1.924	1.537	3.615	965	959	1.113	2.078
N-total	g N/d	96	165	28	289	133	32	128	261
NH <sub>4</sub> -N	g N/d	87	100	1,3	189	104	-4	83	187
N <sub>org</sub>	g N/d	9,0	63	25	97	29	34	43	72
P-total	g P/d	11,0	30	17,0	58	15	15	26	41
K	g/d	24	38	17,3	79	*			62
volume	%	2	31	67	100	31			
COD	%	4	53	43	100	27	27	31	57
N-total	%	33	57	10	100	46	11	44	90
NH <sub>4</sub> -N	%	46	53	1	100	55	-2	44	99
N <sub>org</sub>	%	9	65	26	100	30	35	44	74
P-total	%	19	52	29	100	26	26	45	71

*cursive* = literature value (Otterpohl, 2000) \* not analysed

The comparison of the different volumes shows that the urine volume was very low (2 %) compared to the total volume. But the brownwater volume with 31 % of the total volume was very high. A better understanding of these numbers and the numbers from columns A to C of this table is given in **Fig. 3.6.2**.

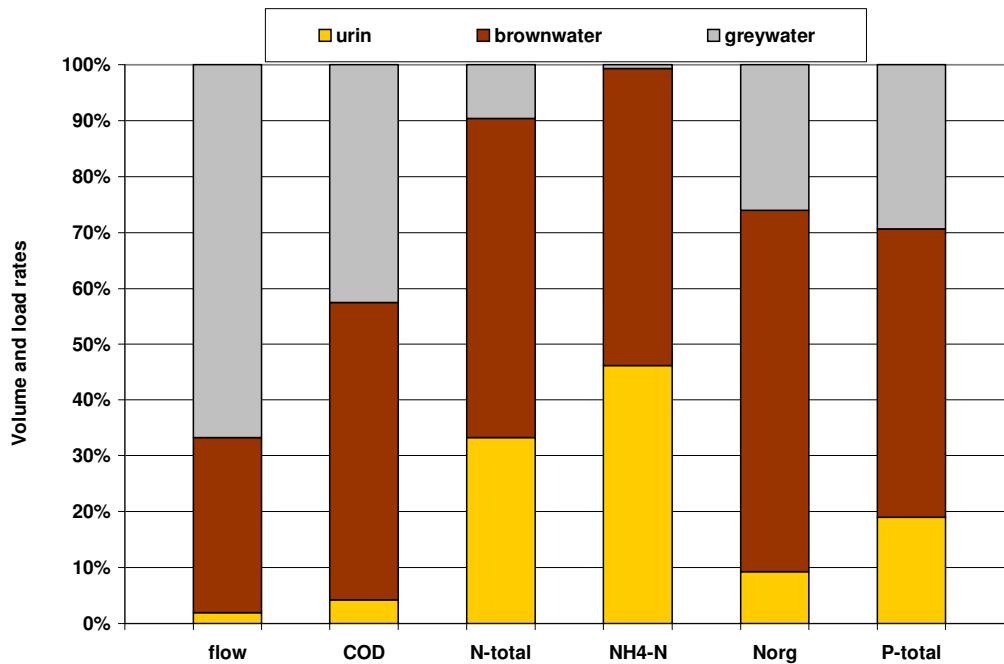

**Fig. 3.6.2:** Volume and mass balances of different parameters of yellow-, brown- and greywater from the apartment house (data basis: yellowwater: *Variant V6b*; brownwater: *Variant V7*; greywater: *Variant V7*)

Most of the organic substances (carbon source as COD) were found in the brownwater. Similarly, most N-total was found in the brownwater. Whereas yellowwater contained nitrogen in the form of ammonium (46 %  $\text{NH}_4\text{-N}$ ), the brownwater was loaded mainly with organic nitrogen (65 %); the ammonium percentage, however, was equally high (53 %). Regarding the distribution of phosphorus, a surprisingly small load was found in the urine (19 %), whereas the highest load was detected in brownwater (52 %).

By comparing the distribution rates with values given in the literature (values printed in kursiv), great differences become apparent. For the brown- and greywater, the charging rates are higher than those given in the literature; and for the urine, the rates are lower than those documented in the literature.

Concerning the use of the nutrients as fertiliser or fertilising products after the treatment of the flows, different calculations were made with the numbers in the columns E to H from **Tab. 3.6.1** - like in the case of the office building. In addition to the flows of urine (column A) and greywater (column C), the brownwater (column B) was separated in the liquid phase, which passed the faeces separator as filtrate (column E), and the solid phase (column F) was being held back by the separator.

Utilising the urine (column A) and the eliminated solids from the faeces (column F), approximately 31 % (literature 59 %) of COD, 44 % (literature 97 %) of N-total, and approx. 45 % (literature 90 %) of P-total from the total charge in all three waters (yellow, brown and grey) was available for the fertiliser or fertiliser production (column G). If the faeces filtrate could also have been used for fertilising, the utilisation rate would have been significantly higher, namely 57 % for COD, 90 % for N-total, and 71 % for P-total (see column H).

In spite of the high elimination rates of the faeces separator, nutrients were leaving the system and could, consequently not be used for fertilisation. Thus, the faeces separation needs to be improved in order to obtain a higher amount of substances for the fertilisation.

### 3.6.4 Comparing the office building with the apartment house

In order to get an idea of the volume rates of yellow-, brown- and greywater from the different tested systems compared to the literature, the data resulting from the calculations of the balances are shown in **Fig. 3.6.3**.

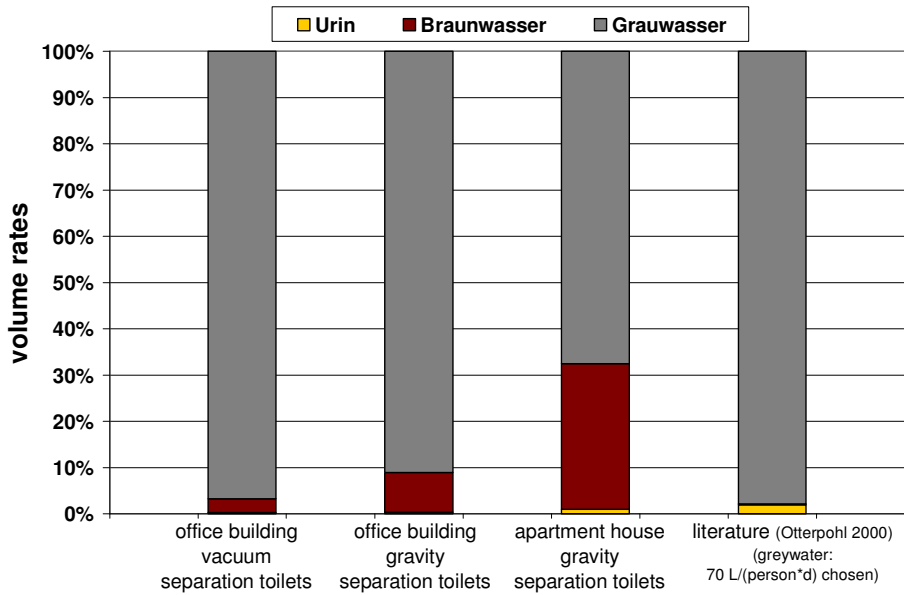

**Fig. 3.6.3:** Comparison of volume rates of yellow-, brown- and greywater from office building and apartment house with data from the literature

The values for the gravity separation toilets from the office building and the apartment house are taken from **Tab. 3.6.1** and **Tab. 3.6.2**, respectively. The values given in the literature are taken from **Fig. 3.6.4**.

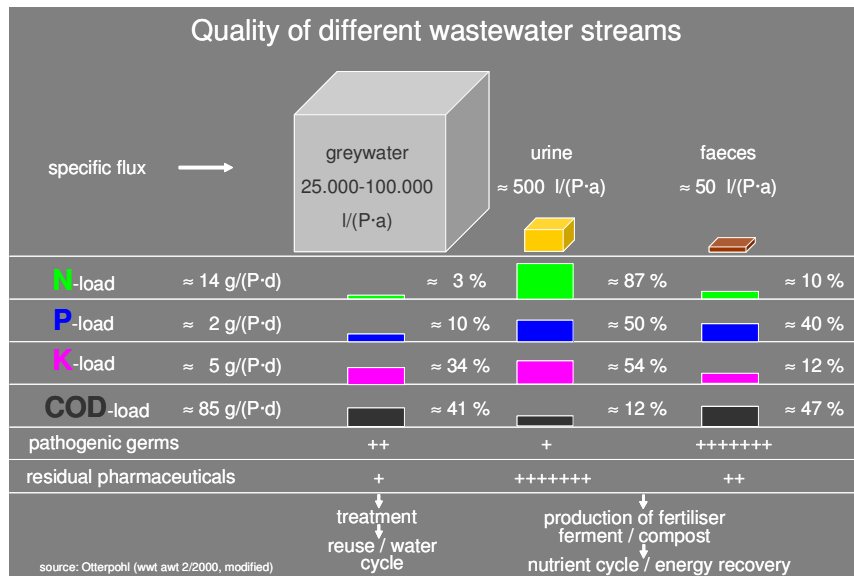

**Fig. 3.6.4:** Quality of different wastewater streams (Otterpohl 2000)

Looking at this figure, it is noticeable that for greywater, the smallest specific volume of 70 L/(person · d) (25,000 L/(person · a)) is chosen. The volume for brownwater is calculated to be 0.14 L/(person · d) (50 L/(person · a)). But this does not include flushing water. The urine volume is specified to be 1.37 L/(person · d) (500 L/(person · a)).

As **Fig. 3.6.3** shows, the measured volume rates for urine are lower than the values given in the literature, and they are negligible in comparison to the brownwater and greywater volumes specified in the literature. The lowest brownwater volume rates were produced with the vacuum separation toilets in the office building. The brownwater rate of the gravity separation toilets in the apartment house was three times higher than the volume rate of the gravity separation toilets from the office building. The main reason for this must be that the users in the apartment house flushed more often than the users from the apartment house (see also chapter 3.1.1). The concentrations of SS and COD in the brownwater from the apartment house, being much lower than the concentrations in the brownwater from

the office building (see **Tab. 3.5.2.1**), support this conclusion. Optimising the tested gravity separation toilets would be important to at least improve the flushing mechanism, resulting in a reduction of the brownwater rate. Unless this improvement is worked on, a high brownwater volume has to be treated at the same time as a high greywater volume needs to be treated.

Similar to the volumes, the load rates of COD, N-total and P-total from the different flows of the office building and the apartment house were also compared to values given in the literature, and presented in a figure (**Fig. 3.6.5**).

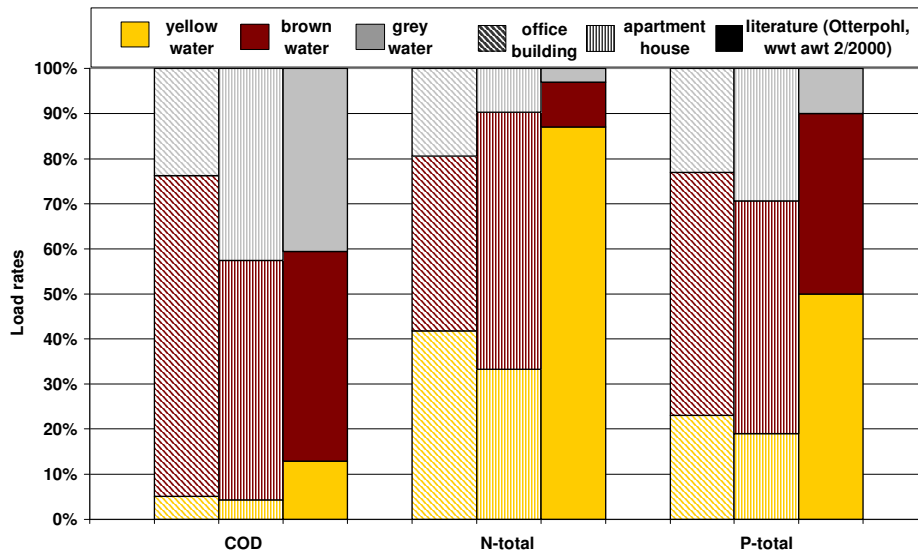

**Fig. 3.6.5:** Comparison of COD, N-total and P-total load rates of yellow-, brown- and greywater from office building and apartment house with data from the literature (Otterpohl 2000)

The values in this figure show that, in both cases, by far the highest concentration of COD was measured in brownwater. The load rates exceeded the load rate given in the literature. This is a positive result, especially when brownwater is intended to be digested or composted. The results were different in the cases of nitrogen and phosphorus: In comparison to the values specified in the literature, in both cases, much less nitrogen could be separated through urine separation. In the case of the apartment house, the largest quantity of nitrogen was found in brownwater. Similar results were obtained for phosphorus. The results for the office building were better than the ones for the apartment house. The reason for this may be the fact that the men mainly used the waterless urinals for urinating. In the apartment house, by contrast, there were no urinals installed.

These results are disappointing since, at the beginning of the project, it was expected that, compared to the values given in the literature regarding urine separation, approx. 70 % to 80 % of nitrogen and phosphorus could be separated through the urine separation. It was not possible to trace the unsatisfying separation effect of the used toilets back to one specific reason. The following aspects, however, could have been a factor in this context:

#### *Office building*

- users did probably not sit down when urinating; in this case, the valve in the urine effluent was closed, and the urine flowed to the faeces effluent;
- the urine effluent could not handle the large volume of urine flows, and urine flowed partially to the faeces effluent;
- the form of the toilet was not optimal for urine separation;

#### *Apartment house*

- the valve of the urine effluent was blocked with precipitants from urine; this was the case in six out of ten toilets (see 3.1.1);
- the urine effluent could not handle the large volume of urine flows, and urine flowed partially to the faeces effluent;
- the form of the toilet was not optimal for urine separation;

In the office building, no blockage of the valves of the urine effluents could be found during the entire operation time. Only small incrustations could be detected. In the case of the apartment house, the first possibility mentioned above can be excluded, since all users (women and men) answered that they were “always sitting down when urinating” in the questionnaires.

### 3.6.5 Plausibility of assessment of source separation

In order to check if the loads in **Tab. 3.6.1** and **Tab. 3.6.2** are plausible, the specific loads for three parameter in g per person and day were calculated; this was done for the office building and for the apartment house, respectively, and then compared to values given in the literature (**Tab. 3.6.3**).

**Tab. 3.6.3:** Comparison of different (several) specific loads of office building and apartment house with values from ATV-DVWK-A 131E (ATV-DVWK 2000)

	office building mean value			apartment house mean value			A 131 85 percentile spec. load g/(person · d)
	g/d s. Tab. 3.6.1	persons/d	spec. load g/(person · d)	g/d s. Tab. 3.6.2	persons/d	spec. load g/(person · d)	
COD	1130	10	<b>113</b>	3615	25	<b>144,6</b>	<b>120</b>
N-total	67	10	<b>6,7</b>	289	25	<b>11,56</b>	<b>11</b>
P-total	12,6	10	<b>1,26</b>	58	25	<b>2,32</b>	<b>1,8</b>

The comparison of the loads of the apartment house with the A 131 values shows that the values do not differ much. One has to bear in mind, however, that this is a comparison between mean values and 85 percentiles, which are by the factor approx. 1.2 – 1.3 higher. Regardless of this inaccuracy, the values of the apartment house can never be very precise (exact), since the precise number of users is not known, and not everybody uses the toilets at home at all times. But the figures show that the mass balances in the chapters above may be sufficiently accurate.

The values of the office building differ from the values of the apartment house. The values for N-total and P-total are plausible. They must be lower than those of the apartment house since the users also used the toilets at home. The value for COD seems to be very high. The main reason for this may be the fact that the staff of the office building, especially the blue-collar workers, often took showers, producing a lot of greywater (see **Tab. 3.6.1**), which increases the quantity of COD. Like in the case of the numbers of the apartment house, the numbers regarding the office building cannot be very precise since the exact number of toilet users is not known, either. Considering these facts, the mass balances calculated for the office building are also sufficiently accurate.

Another interesting aspect of the mass balances is the load of nitrogen: it should be checked if a maximum load of nitrogen of approx. 87 % (see **Fig. 3.6.4**) from all three volumes (yellow-, brown- and greywater) is available for separation in the urine. In order to test this hypothesis, the specific loads in g per person and day were calculated based on the values in the urine collected from a project team member (see **Tab 3.4.1**), and then compared to values mentioned in the literature (**Tab. 3.6.4**).

**Tab. 3.6.4:** Comparison of different specific loads in the urine of a member of the project team with values from ATV-DVWK-A 131E (ATV-DVWK 2000)

	morning urine mean value			urine without morning urine mean value			A 131 85 percentile spec. load g/(person · d)
	mg/L s. Tab. 3.4.1	L/d	spec. load g/(person · d)	mg/L s. Tab. 3.4.1	L/d	spec. load g/(person · d)	
COD	12014	1,2	14,4	10989	1,2	13,2	<b>120</b>
N-total	8582	1,2	<b>10,3</b>	8163	1,2	<b>9,8</b>	<b>11</b>
P-total	878	1,2	1,1	706	1,2	0,8	<b>1,8</b>

As the results in this table show, in both cases, the specific N-total load is near the values given in the literature. Since the values from the analysed urine are mean values, and the values mentioned in the

literature are 85 percentile values, the nitrogen loads found in the urine represent over 90% of the nitrogen loads of all three volumes. This is confirmed by / This confirms the value in **Fig. 3.6.4**.

## 4 Results of co-operating institutions

### 4.1 Urine treatment

The Technical University Hamburg-Harburg carried out the following experiments regarding urine treatment (**Task 7**):

- Steam stripping;
- Vacuum evaporation;
- Combinations;
  - a) *Improvement of resource production*
    - MAP-precipitation;
    - Crystallisation;
  - b) *Elimination of pharmaceutical residues*
    - UVC-radiation;
    - Ozone-treatment;
    - Crystallisation.

The experiments showed that all processes are technically feasible. Main results were: The use of steam stripping resulted in an ammonia solution with a concentration of 15 %. Through using evaporation, 20 L concentrate could be produced from 1 m<sup>3</sup> urine. As a result of the constant thermal influence, most of the analysed micro pollutants could be reduced considerably. All investigated micro pollutants could be removed through ozonation. For more details see the separate report (Tettenborn et al., 2007).

### 4.2 Fertiliser usage

In order to examine the fertilising properties of urine and composted faeces as well faeces from the vacuum plant, the Humboldt University of Berlin carried out the corresponding pot and field trials (*Task 8*). Fertiliser experiments with digested faeces were not carried out as the operation of the biogas plant could not be started on time.

In general, the fertilising trials showed that the yields of the crops fertilised with mineral fertiliser were as high as those of the crops fertilised with urine. This proves that urine indeed has a high fertilising potential. It has been estimated that the urine of Berlin's and Brandenburg's inhabitants could substitute 40 % of the nitrogen currently being used for fertilising purposes in the region. When looking at the financial year 2003/2004, the rate of phosphorus that could be substituted even rises to 75 % of the fertiliser quantity used. Overall results of producer and consumer surveys are positive. For more details see the separate report (Muskolus and Elmer, 2007).

### 4.3 Life-Cycle-Assessment

The Technical University of Berlin carried out a Life-Cycle-Assessment (LCA) (*Task 5*) for an existing residential area in Berlin:

- residential area in Berlin: 5,000 inhabit., 1,000 buildings;
- period of 50 years;
- total project costs (dynamic prime costs).

Comparison of

- *conventional Sanitation system* with
- new Sanitation concepts:
  - a) *Gravity-Separation* toilets;
  - b) *Vacuum-Separation* toilets;

Main results were: Normalised eco-profiles of the different sanitation scenarios showed that new sanitation concepts have a less negative impact on the environment than the conventional system (**Fig. 4.1**).

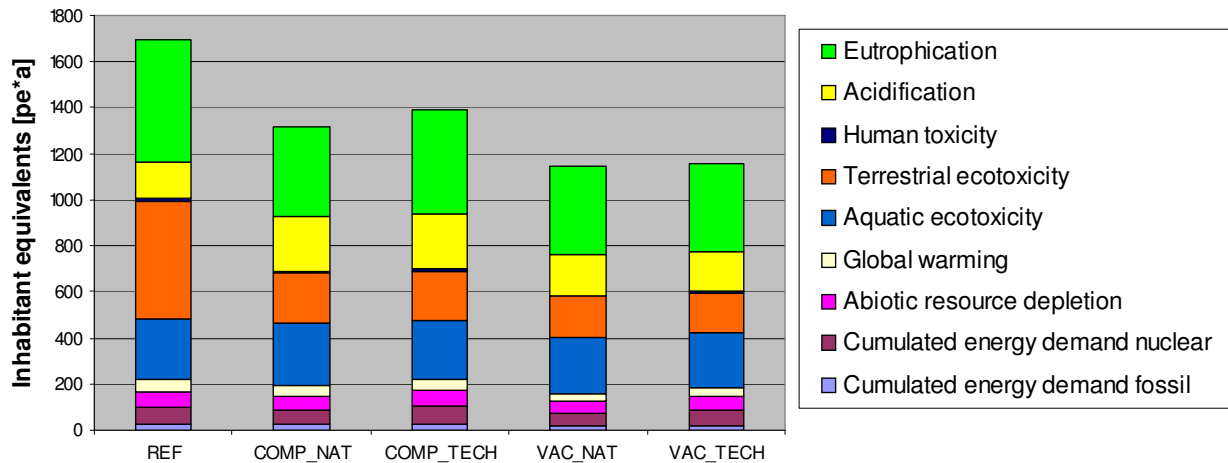

**Fig. 4.1:** Normalised eco-profiles as inhabitant equivalents (environmental impact) of conventional system (Ref) and different configurations for alternative sanitation systems (Comp/Vac: faeces composting/digestion, Nat/Tech: Greywater treatment with soil filter/SBR)

The less negative effect is mainly due to less heavy metal enrichment on farmlands using fertilisers from the new sanitation concepts instead of mineral fertilisers and due to less eutrophication of the receiving water bodies. However, the ecological advantages could only be realized if secondary functions of alternative systems (e.g. substitution of mineral fertilizer, energy production via faeces digestion) were to be implemented. Furthermore the results from the LCA were received based on the fact that urine will not be treated before using it as fertiliser. Should a urine treatment be necessary with different processes for the concentration of nutrients like nitrogen and phosphorus as well for removing micropollutants (pharmaceuticals, steroids) the new sanitation concepts would still have ecological advantages but less. A further prerequisite for the LCA was that 75 % urine can be separated with the separation toilets. But this high separation efficiency could not be realised with the toilets used for this project. The separation efficiency was between 30 and 40 %. For more details see the separate report (Remy et al., 2007).

#### 4.4 Costs

The company Otterwasser GmbH, which was a consultant to this project, also carried out a cost comparison for the same residential area as the one included in the LCA experiments. The Otterwasser study, however, included additional variants:

- residential area in Berlin: 5,000 inhabit., 1,000 buildings;
- period of 50 years;
- total project costs (dynamic prime costs).

Comparison of

- *conventional Sanitation system* with
- new Sanitation concepts:
  - a) *Gravity*-Separation toilets;
  - b) *Vacuum*-Separation toilets;
  - c) additional variants.

Main results of the cost calculation are shown in **Fig. 4.2**.

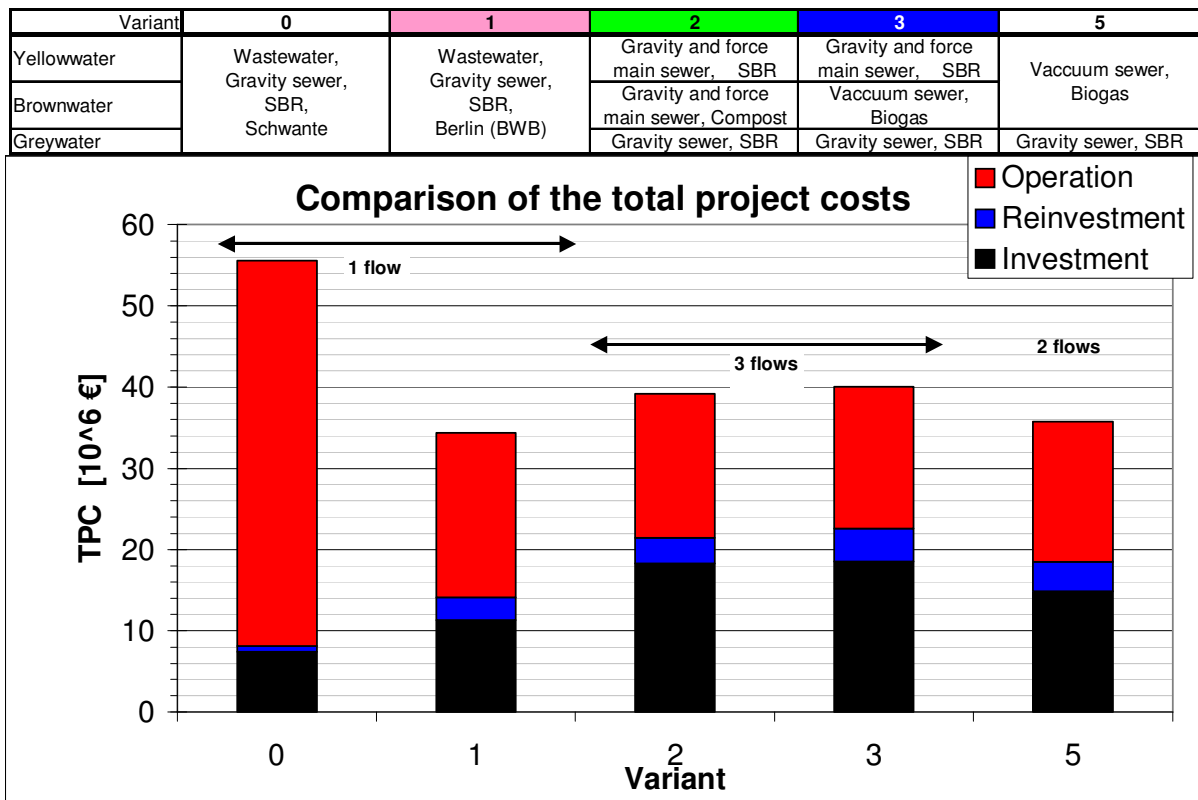

**Fig. 4.2:** Total project costs (TPC) of the different calculated variants

The cost comparison revealed that because of the high installation costs, the total project costs for new sanitation concepts (*Variant 2* and *Variant 3*) were not lower than the costs involved in the conventional solution (*Variant 1*). This refers to the exemplary Berlin residential area in a 50-year-time-frame. The high costs for the new sanitation concepts are caused by the installations inside and outside the houses. The operating costs, however, are lower for the new sanitation concepts than for the conventional concepts; this is in accordance with findings in the literature (Dockhorn and Dichtel, 2004). Assuming that energy costs will increase, the new sanitation concepts may have operating costs that will be up to 20 % lower than those of conventional concepts, based on cost-savings through the winning of biogas from digestion processes.

If a different cost basis (costs from a wastewater system of a small village near Berlin instead of costs from Berliner Wasserbetriebe) is used to calculate the costs of the conventional system (*Variant 0*), the new sanitation concepts (*Variant 2* and *Variant 3*) become much more cost-efficient.

Using not a 3-flow but a 2-flow system for a new sanitation concept, the costs are similar (*Variant 5*) to those of the conventional concepts calculated on the basis of the costs of the Berliner Wasserbetriebe (*Variant 1*).

These results show that the costs for new sanitation concepts can be either higher than, the same as, or lower than the costs involved in conventional sanitation systems. It highlights the fact that the costs always depend on the special circumstances. For more details see the separate report (Oldenburg and Dlabacs, 2007).

### 5 Summary and conclusions

This demonstration project started on January 1<sup>st</sup>, 2003, and was completed on December 31, 2006. Two different sanitation concepts were tested. The two concepts differed in the following two points:

- Gravity separation toilets and composting of the faeces;
- Vacuum separation toilets and digesting of the faeces.

As demonstration site served the office building of the wastewater treatment plant Stahnsdorf and a nearby apartment house. Both belong to the Berliner Wasserbetriebe.



First, the project started with the gravity separation toilets installed in the office building. The toilets were put into operation in October 2003, and the outside treatment facilities were started in March 2004. The vacuum separation toilets in these building were brought into operation step by step, replacing the gravity separation toilets. The first vacuum separation toilet was put into operation in December 2003, the next two in December 2004 and the last six in April 2005. The concept with gravity separation toilets was not given up since this type of toilet was being used in ten flats in the apartment house from April 2005 onwards with a user community that was more representative than the one in the office building. The biogas plant for the anaerobic treatment of the faeces from the vacuum separation toilets was installed in July 2006.

In the EU-proposal, eight different variants were identified for testing (see 2.2). Of these eight variants, the following seven variants (V) were tested:

- *V1 (with soil filter and with faeces filtrate treatment);*
- *V2a (without soil filter and without faeces filtrate treatment);*
- *V2b (without soil filter and with faeces filtrate treatment);*
- *V5 (with membrane bio-reactor and with faeces filtrate treatment);*
- *V7 (membrane bio-reactor with greywater from apartments and with faeces filtrate treatment);*
- *V6a (with digester and the half constructed wetland);*
- *V6b (with digester and the complete constructed wetland).*

The following variants could not be tested:

- *V3 (Grey- and brownwater mixture and with soil filter);*
- *V4 (Grey- and brownwater mixture and without soil filter);*
- *V8 (Faeces from office building via vacuum and composting).*

*Variant V3* and *V4* could not be tested because the dewatering capacity of the faeces separator was too low. *Variant V8* could not be tested, either, because the faeces separator was installed too far away from the office building; thus, the installation of a vacuum pipe for this separator would have been too complicated.

In order to learn more about user acceptance of the new toilets and waterless urinals, a user survey with questionnaires was undertaken. The results reflect an overall acceptance of the gravity separation toilets; the only point of critique was the flushing system that needs to be improved. Acceptance of the vacuum separation toilets, however, is lower, especially with regard to the flushing and the flushing noise. This was to be expected since these toilets were modified gravity separation toilets, and, therefore, rather prototypes than ready-to-use, marketable toilet models. To this day, an optimised vacuum separation toilet is not available on the market. With regard to the urine effluent, due to precipitations, blockages appeared in six out of the ten toilets in the apartment house. Basically, the experience with the two types of separation toilets show that they need to be improved before they can be used on a larger scale. The vacuum system itself was generally reliable: there were only two disturbances during the project. One was caused by a vacuum valve that did not close, the other one was a blockage after the disposal of paper, which is normally used for hand drying (one-way disposable paper towels) after hand washing. This exemplifies a typical misuse of the toilets on the part of the user. There was not any problem with the different pipes for yellow, brown- and greywater. Only a small degree of sedimentation could be observed in the transparent control pipes of the horizontal part of the main urine pipe.

The urine from both buildings was much less concentrated compared to values recorded in the literature. The reason for this could not be identified. The values given in the literature could be confirmed by the urine of one project team member. Apart from the chemical/physical parameters, the urine was also tested for micro-pollutants (16 substances). Most of these substances had concentration levels too low to be detected. Higher concentration levels were found for Bezafibrat and Ibuprofen. Stored urine was used for fertilising experiments by the Humboldt University Berlin (*Task 8* of the project) and for urine treatment tests of the Technical University Hamburg-Harburg (*Task 7* of the project).

During different variants, the faeces from gravity separation toilets were composted. Before the faeces could be composted, the wet material needs to be dewatered. This was done inside the filter bags, which separated the solids from the liquid. With this separation technique, about 90 % of the suspended solids (SS), 55 % of N-total and 50 % of P-total could be retained in the filter bags. Although most of the solids could be retained in the filter bags, the SS-concentration of about 300 mg/L in the

filtrate was very high and not satisfying. Therefore, the separation process should be improved, not only concerning the better quality of the filtrate but also concerning the equipment (handling etc.). The existing kind of faeces separator used in the project was chosen only to demonstrate the dewatering of the faeces and their handling afterwards. For larger units, the optimization of the separation and dewatering equipment would be indispensable.

For composting the thickened faeces, worms were added. Composting took place in two different ways at the Humboldt University Berlin: One way was composting in a building at around 20 °C, and the other way composting outside at normal air temperature between spring and autumn. In both cases satisfying results were achieved.

For pre-treating the faecal filtrate from the faecal separator, especially to reduce pathogenic germs, a soil filter was tested. The operation of this filter was not successful because the SS-concentration of the faecal filtrate was too high. Consequently, the operation of the filter was halted after two months.

A two-chamber septic tank was used as a pre-treatment step for the constructed wetland. Until the end of June 2005, only greywater and faeces filtrate from the office building was treated. From July 2005 until June 2006, greywater and faeces filtrate from the apartment house was pumped to the septic tank. The septic tank was extremely under-loaded with only the loads from the office building. The efficiency increased considerably when the greywater and the faeces from both houses were fed into the tank. The expected elimination of approx. 20 % to 30 % of the suspended solids was achieved.

Similar to the septic tank, the constructed wetland was under-loaded during the first project phase. After the grey- and brownwater from the apartment house were also pumped to the treatment facilities, the hydraulic load corresponded to the designed load. In the first year of operation, the distribution of the grown reed in the constructed wetland showed a worsened water distribution. Therefore, the distribution system was retrofitted in April 2005. From then on, the distribution of the influent was satisfying. In most cases, the COD-effluent concentrations were far below 40 mg/L. The ammonium was completely nitrified. The denitrification rate was approx. 50 %. For most variants, the P-total-effluent concentration was below 1 mg/L. But in order to reach a low effluent value, an additional phosphorus elimination step such as precipitation would have to be integrated. Apart from chemical parameters, pathogenic germs were analysed. In most cases, the values of total and faecal coliforms were below the value of excellent quality set out in the EU bathing water directive. The values only went above the standards defined as "good quality" in the EU-directive, when the constructed wetland was hydraulically loaded as anticipated in the project-design, and when greywater from both buildings was fed into the wetland.

In parallel with the constructed wetland, a membrane bio-reactor (MBR) was operated from May 25, 2005 onwards. Until the end of June, the influent consisted just of greywater discharged from the office building. Starting from July, the influent consisted of a mixture of greywater from the office building (approx. 48 %), and the apartment house (approx. 52 %). The effluent quality with regard to SS, COD and NH<sub>4</sub>-N was satisfying. The phosphorus elimination was not sufficient and should be improved further. With regard to the nitrogen parameters, the effluent concentrations of the MBR were similar to the effluent concentrations of the constructed wetland. But for COD and P-total, the concentrations were higher.

For treating the brownwater from the vacuum plant, a two stage thermophile biogas plant was tested. These tests could only be carried out during the last six months of the project. It was possible to digest the brownwater without thickening. Further tests were carried out with pre-thickening, and pre-thickening including added bio waste. The gas production was comparable with values from digesters of municipal WWTP's. The hydraulic retention time was approx. seven days. But for more reliable results, the biogas plant should be operated for a much longer time.

Based on the analytical values, mass balances for the different variants and sanitation concepts run and tested in the office building and the apartment house were calculated. These data were compared to values given in the literature. These comparisons showed that the yellowwater from both buildings contained far less nutrients than documented in the literature, whereas the brown- as well the greywater contained more. Furthermore, a significant part of nutrients from brownwater got lost through the faeces filtrate.

Other parts of the project were run by co-operation partners:

The Technical University of Hamburg-Harburg analysed the treatment of urine using different processes. The most interesting process combination was steam stripping and MAP-precipitation. The pharmaceutical residues could be completely removed with ozonation. For more details see the separate report (*Annex 6.3*).

The Humboldt University Berlin carried out pot and field tests with urine and faeces compost as well as producer (farmer) and consumer surveys. The results of the fertilising experiments are comparable with results using mineral fertiliser. The survey results are encouraging in terms of the acceptance of the new sanitation concepts. For more details see the separate report (*Annex 6.4*).

The Technical University Berlin undertook a Life-Cycle-Assessment (LCA). The results show that the tested new sanitation concepts have advantages over the conventional sanitation system. But the results are based on a urine separation rate of 75%. In the tested new sanitation concepts, only 41% (office building) and 33% (apartment house) could be separated. For more details see the separate report (*Annex 6.2*).

In addition to being a consultant to the entire project, the company Otterwasser GmbH worked out a cost comparison scheme. In this scheme they compared the costs of the conventional sanitation system with the costs involved in new sanitation concepts. The costs depend to a large extent on the specific circumstances of a settlement. The results show that the new sanitation concepts may be less, more or as cost-efficient as the conventional systems. For more details see the separate report (*Annex 9*).

The final conclusions of this project are:

- On the whole, the tested sanitation concepts work;
- Some technical details (toilets, faeces separator etc.) need be improved;
- Overall, the tested urine treatment processes are feasible;
- Urine as fertiliser is equivalent to mineral fertilisers;
- The results from user, consumer and farmer surveys are encouraging, but the application of the different new fertilisers is not in accordance with the laws and directives at the moment. Especially the pharmaceutical residues are the focus of the actual discussion. The acceptance of the fertilizers and the harmlessness for its application is important for their introduction. Many experts dealing with new sanitation concepts, however, consider the benefits that can be derived from the use of these products as being far bigger than the damages that can be caused by these micro-pollutants;
- The eco-balance of the tested sanitation concepts is more favourable than the eco-balance of conventional sanitation systems;
- Costs involved depend to a large extent on the situation;
- On the whole, results of the SCST project show that there is a good potential for development, especially regarding sanitary facilities;
- Since issues such as water reuse, nutrient recycling and energy are very high on the agenda, more and more further developments are necessary for a more widespread use of alternative sanitation concepts;
- Activities relating to new sanitation concepts are increasing world-wide.

Examples for further existing projects are Solar City in Linz (Austria), office building Griesbach of EAWAG (Switzerland) and in Germany in the settlement Flintenbreite (Lübeck), by the company Hans-Huber (Berching), in the Lambertsmühle (Burscheid) and by the GTZ (Eschborn). In these projects further developments are in progress.

Besides of the projects mentioned above one more very important activity for this issue is undertaken by the founded commission "Neuartige Sanitärsysteme" (novel sanitation systems) by the DWA (Deutsche Vereinigung für Wasserwirtschaft, Abwasser und Abfall e.V.) in the year 2005 which is collecting and publishing the up-to-date knowledge to this issue.

Last but not least, it should be highlighted that there has been and still is a strong interest in this demonstration project. Up to this day, the project has been presented on-site to national and international visitors (approx. 500) about 68 times. This vivid interest can be seen as a result of the internet presentation of the project provided by the KompetenzZentrum Wasser Berlin ([www.kompetenz-wasser.de\Forschung\SCST](http://www.kompetenz-wasser.de\Forschung\SCST)), numerous publications in newspapers and in special-

ised journals as well as information presented in radio shows (17), and presentations given at national and international conferences (31).

This demonstration project is being co-financed in the framework of the LIFE programme of the European Commission (LIFE 03 ENV/D/000025)



**Abbreviations**

BOD	mg/L	g/d	biological oxygen demand
Brownwater			faeces including flush water
Ca	mg/L		calcium
Cd	mg/L		cadmium
CHPU			Combined Heat and Power Unit
Cl	mg/L		chlorine
COD	mg/L	g/d	chemical oxygen demand
Cr	mg/L		chrome
Cu	mg/L		copper
DO	mg/L	mgO <sub>2</sub> /L	dissolved oxygen
DR	mg/L		dry residue
vDR	mg/L		volatile dry residue
DS	kg		dry solids
effl.			effluent
EU			European Union
Greywater			waste water mainly from kitchen, bathroom, washing machine and wash basins without brown- and yellowwater
Hg	mg/L		mercury
HRT	h		hydraulic retention time
infl.			influent
K	mg/L		potassium
MBR			membrane bio-reactor
Mg	mg/L		magnesium
NH <sub>4</sub> -N	mg/L	g/d	ammonia nitrogen
Ni	mg/L		nickel
NO <sub>2</sub> -N	mg/L	g/d	nitrite nitrogen
NO <sub>3</sub> -N	mg/L	g/d	nitrate nitrogen
Norg	mg/L	g/d	organic nitrogen
N-total, TN	mg/L	g/d	total nitrogen
Pb	mg/L		lead
P <sub>F</sub>	mbar		pressure filtration
PO <sub>4</sub> -P <sub>f</sub>	mg/L	g/d	dissolved phosphate-phosphorus
P <sub>R</sub>	mbar		pressure relaxation
P-total, PT, TP	mg/L	g/d	total phosphat-phosphorus
q <sub>A</sub>	m <sup>3</sup> /m <sup>2</sup> .d		surface flow rate
Q <sub>A</sub>	L/d	m <sup>3</sup> /d	dry weather flow
Q <sub>L</sub>	Nm <sup>3</sup> /d		standard cubicmeter
SRT		d	sludge retention time
SS, TS	mg/L	g/d	suspended solids
TMP	mbar		transmembrane pressure
TOC	mg/L		total organic carbon
WWTP			Wastewater treatment plant
Yellowwater			urine without flush water
Zn	mg/L		zinc

## References

- ATV-DVWK (2000): Dimensioning of Single-Stage Activated Sludge Plants ATV-DVWK-A 131E. GFA Publishing Company of ATV-DVWK Water, Wastewater and Waste, Hennef, [www.gfa-verlag.de](http://www.gfa-verlag.de).
- 2H Kunststoff (2007): H PP-Media KVP. [www.2h-kunststoff.de](http://www.2h-kunststoff.de).
- A3 GmbH (2005): [www.a3-gmbh.com](http://www.a3-gmbh.com).
- Dockhorn, T., Dichtl, N. (2004): A Decision Support Tool for Implementing a Sustainable Resource Management in the Sector of Municipal Wastewater Treatment. . 2nd Leading-Edge Conference on Sustainability in Water-Limited Environments, 8 -10 November 2004 in Sydney, Australia
- Duravit (2005): Products, [www.duravit.de](http://www.duravit.de).
- Edertal (2007): Standwolf Typ EM 98. [www.edertal-elektromotoren.de](http://www.edertal-elektromotoren.de).
- Ernst (2005):Ernst systems, [www.ernstsystems.com](http://www.ernstsystems.com).
- EU-Badewasserrichtlinie (1975): Richtlinie des Rates vom 8. Dezember 1975 über die Qualität der Badegewässer (76/160/EGW). Amtsblatt der Europäischen Gemeinschaften, Nr. L 31/1.
- Fugafil-Saran (2005): Fugafil saran, [www.fugafil.de](http://www.fugafil.de).
- Hans Huber (2007): Thermopile two-stage Biogas-plant. [www.huber.de](http://www.huber.de).
- Keramag (2007): Centaurus urinal. [www.keramag.com](http://www.keramag.com).
- Labor 28 (2005): Labor 28 AG, [www.labor28.de](http://www.labor28.de).
- Lütznert, K. and Kühn, V. (2000): Kanalisation und Abwasserbehandlung, Teil 3, Schlammbehandlung. Lehrmaterial zur Vertiefervorlesung, TU Dresden.
- Muskolus, A. and Ellmer, F. (2007): Fertiliser Usage. Final report for task 8 of the demonstration project "Sanitation Concepts for Separate Treatment of Urine, Faeces and Greywater" (SCST), [www.kompetenz-wasser.de/research/SCST](http://www.kompetenz-wasser.de/research/SCST).
- Oldenburg, M. and Dlabacs, C. (2007): Cost Calculations. Final report for a subtask of the demonstration project "Sanitation Concepts for Separate Treatment of Urine, Faeces and Greywater " (SCST), [www.kompetenz-wasser.de/research/SCST](http://www.kompetenz-wasser.de/research/SCST).
- Otterpohl, R. and Niederste-Hollenberg (2000): Innovative Entwässerungskonzepte. *wwt* 2/2000, S 23 – 26.
- Otterpohl, R. (2001): Black, brown, yellow, grey – the new colours of sanitation. Magazine of the International Water Association, WATER 21, October.
- Remy, C., Ruhland, A. and Jekel, M. (2007): Ecological assessment of alternative sanitation concepts with Life Cycle Assessment. Final report for task 5 of the demonstration project "Sanitation Concepts for Separate Treatment of Urine, Faeces and Greywater" (SCST), [www.kompetenz-wasser.de/research/SCST](http://www.kompetenz-wasser.de/research/SCST).
- Roediger (2001): Roediger-No Mix Toilet. [www.roeva.de](http://www.roeva.de).
- Udert, K.M., Larsen, T.A. and Gujer, W. (2004): Fate of Major Compounds in Source-Separated Urine. 4<sup>th</sup> IWA World Water Congress Sep. 2004 in Marrakech, Morocco, Paper CD.
- Universität Duisburg (2005): Institut für Wasserchemie und Wassertechnologie (IWW), [www.theochem.uni-duisburg.de](http://www.theochem.uni-duisburg.de).
- Urimat (2005): Product info, [www.urimat.com](http://www.urimat.com).

Tacke (2005): Regenwurmfarm Tacke GmbH, [www.regenwurm.de](http://www.regenwurm.de).

Tettenborn, F., Behrendt, J. and Otterpohl, R. (2007): Resource recovery and removal of pharmaceutical residues - Treatment of separate collected urine. Final report for task 7 of the demonstration project "Sanitation Concepts for Separate Treatment of Urine, Faeces and Greywater" (SCST), [www.kompetenz-wasser.de/research/SCST](http://www.kompetenz-wasser.de/research/SCST).

Winter, K.J. and Goetz, D. (2004): Einfluss der Abwasserzusammensetzung auf die Kolmationsneigung vertical durchströmter Bewachsener Bodenfilter. KA (51), Nr. 9, S. 961- 966.